

## A BOARDS



### DOUBLE SIDED SIDEWALK SIGNS WITH CLICK CLACK OPENING DESIGN

Header board and brochure basket options are available. Easy-to-open snap frame includes the anti-reflex cover in all standard A boards. Frame size alternatives are A2, A1, A0, 500x700 mm, 700x1000 mm, 20"x30" and 30"x40".

### KEY SELECTION ATTRIBUTES

- \* Double-sided Pavement Sign with "Click Clack" snap open design
- \* Suitable for poster sizes A2, A1, A0, 500x700mm, 20"x30" and 30"x40"
- \* One set includes double sided snap open frames, 2 anti-reflex poster covers, hinges, and scissors for keeping the system stable.
- \* Optional Wire Header Holder, Header Board and Brochure Baskets are

- not included, should be ordered separately.
- \* Galvanised metal back panel provides stability.
- \* Natural silver-anodized, black in standard and various RAL colors available with antimicrobial powder coating.
- \* Packed in a single box.



Black, Round Corner



Round corner



Silver, Round Corner



Black, Mitred Corner



## COLOURS IN STOCK

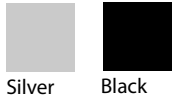

Silver Black

## COLOUR OPTIONS

White - RAL 9003

Red - RAL 3020

Green - RAL 6029

Blue - RAL 5002

## CORNER TYPES



## SUITABLE FOR

A Boards can be used for INDOOR and OUTDOOR applications, for signage needs in many locations like shopping centers, markets, groceries, hotels, offices airports, shops and stores, hospitals, schools, apartments and many more.

## WATCH VIDEO



Watch video at our website [www.mtdisplays.com](http://www.mtdisplays.com)

## FEATURES



Also see with safe corner

## EXPLODED VIEW

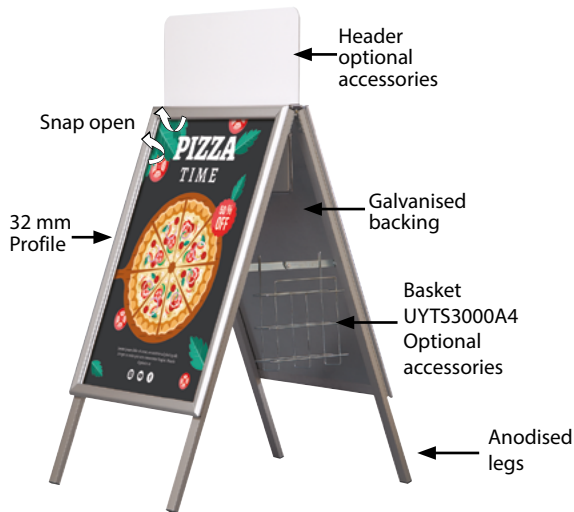

## TECHNICAL DRAWING

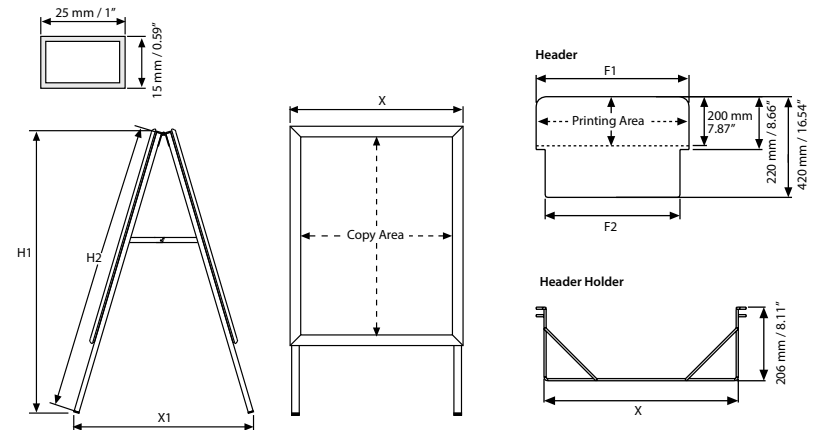

## ARTICLES

										WEIGHT	PACKING SIZE
MITRED SILVER	ROUND SILVER	MITRED BLACK	ROUND BLACK	SAFE CORNER	POSTER	X	X1	H1	H2	WITH PACKING	*W X H X D
UAB3250NA2	UAB3200NA2	UAB3250BA2	UAB3200BA2	UAB3210NA2	420 X 594 mm	463 mm	700 mm	905 mm	950 mm	6,200 kg	480 X 1000 X 112 mm
UAB3250NA1	UAB3200NA1	UAB3250BA1	UAB3200BA1	UAB3210NA1	594 X 841 mm	637 mm	800 mm	1100 mm	1150 mm	10,350 kg	750 X 1280 X 112 mm
UAB3251NA1	UAB3201NA1	UAB3251BA1	UAB3201BA1	UAB3211NA1	594 X 841 mm	637 mm	750 mm	1005 mm	1050 mm	10,200 kg	750 X 1180 X 112 mm
UAB3250NA0	UAB3200NA0	UAB3250BA0	UAB3200BA0	UAB3210NA0	841 X 1189 mm	884 mm	910 mm	1400 mm	1450 mm	18,510 kg	910 X 1520 X 112 mm
UAB3250NB2	UAB3200NB2	UAB3250BB2	UAB3200BB2	UAB3210NB2	500 X 700 mm	543 mm	700 mm	905 mm	950 mm	8,350 kg	650 X 1120 X 112 mm
UAB3250NB1	UAB3200NB1	UAB3250BB1	UAB3200BB1	UAB3210NB1	700 X 1000 mm	743 mm	850 mm	1195 mm	1250 mm	13,350 kg	840 X 1420 X 112 mm
UAB3250N23	UAB3200N23	UAB3250B23	UAB3200B23	UAB3210N23	20" X 30"	21.69"	27.56"	905 mm	950 mm	19,841 lbs	25.59" X 44.09" X 4.41"
UAB3250N22	UAB3200N22	UAB3250B22	UAB3200B22	UAB3210N22	22" X 28"	19.69"	27.56"	1195 mm	1250 mm	19,841 lbs	27.56" X 42.13" X 4.41"
UAB3250N34	UAB3200N34	UAB3250B34	UAB3200B34	UAB3210N34	30" X 40"	31.69"	33.46"	47.04"	49.21"	30,423 lbs	31.89" X 50.39" X 4.41"



T: +90 850 433 67 85 / [info@mtdisplays.com](mailto:info@mtdisplays.com) / [www.mtdisplays.com](http://www.mtdisplays.com)

## ARTICLES

HEADER			WEIGHT	HEADER HOLDER			WEIGHT
ARTICLE	F1	F2	WITH PACKING	ARTICLE	X	WITH PACKING	
UYFT0000A2	460 mm	382 mm	0,675 kg	UYTT0000A2	405 mm	0,600 kg	
UYFT0000A1	640 mm	562 mm	0,850 kg	UYTT0000A1	579 mm	0,800 kg	
UYFT0000A0	890 mm	812 mm	1,500 kg	UYTT0000A0	826 mm	0,900 kg	
UYFT0000B2	540 mm	462 mm	0,750 kg	UYTT0000B2	485 mm	0,750 kg	
UYFT0000B1	740 mm	662 mm	1,400 kg	UYTT0000B1	685 mm	0,850 kg	
UYFT000022	23.54"	20.47"	1.543 lbs	UYTT000022	17.44"	1.609 lbs	
UYFT000023	21.57"	18.50"	1.763 lbs	UYTT000023	19.41"	1.653 lbs	
UYFT000034	31.57"	28.50"	3.196 lbs	UYTT000034	29.41"	1.918 lbs	

## OPTIONAL ACCESSORIES



A Board header  
(4 mm PVC Foam).



A board basket A4 size  
to hang on scissors.  
UYTS3000A4

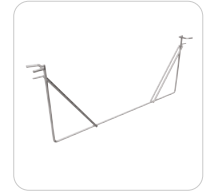

A Board wire header  
holder.

## PHYSICAL DATA

### Material

32mm aluminium profile click clack snap open frame, PET anti-reflex poster cover, galvanised metal backing. PVC Foam optional header.

### Poster Material & Thickness

0,10 – 0,20 mm for standard product. Max poster thickness 3 mm for mitred corner, 2 mm for round corner. Any non-standard poster thicknesses should be indicated with order.

### Surface Finish

Natural silver-anodized, or black in standard and various RAL colors available with antimicrobial powder coating. Call for custom color requests.

### Recycled Content

Up to 70% recycled content used.

### Warranty

All products are guaranteed for 2 years by MT Displays with below conditions:  
[Warranty Conditions](#)

### Installation Considerations

A Boards are packed in a single box with an easy-to-understand instruction sheet. One set includes double sided snap open frames, 2 anti-reflex poster covers, hinges, and scissors for keeping the system stable. Each unit has water drainage slots on bottom profiles. No tool assembly. Optional Wire Header Holder, Header Board and Brochure Baskets are not included, should be ordered separately.

### Storage Conditions

Goods should be stored at 0° to 25°C in a dry place. Store in the original package.

### Design Considerations

Double-sided Pavement Sign with "Click Clack" snap-open design. Suitable for silk screen printing, max. letter height is 16 mm. Suitable for A2, A1, A0, 500x700mm, 20"x30" and 30"x40" poster sizes with a sight angle that stops passers-by. Galvanised metal heavy back panel provides stability.

### Cleaning and Disinfecting

Clean your displays, with damp microfiber clothes, rinsed with simply water or warm, soapy or gentle shampooed water. Avoid using vinegar, abrasive, acidic, alcohol-based or heavy cleaners or cleaners containing Ammonia. Only after cleaning the product, if needed, simply apply disinfectant or sanitizer that is in compliance with your local guidelines and regulations.

## PRINT TEMPLATES

### A Board - A2

Document Size: 430 x 604 mm (Includes Bleeds)  
Finished Size: A2 (420 x 594 mm) [Print](#)

### A Board - A1

Document Size: 604 x 851 mm (Includes Bleeds)  
Finished Size: A1 (594 x 841 mm) [Print](#)

### A Board - A0

Document Size: 851 x 11.4" (Includes Bleeds)  
Finished Size: A0 (841 x 1199 mm) [Print](#)

### A Board - B2

Document Size: 510 x 710 (Includes Bleeds)  
Finished Size: B2 (500 x 700 mm) [Print](#)

### A Board - B1

Document Size: 710 x 1010 (Includes Bleeds)  
Finished Size: B1 (700 x 1000 mm) [Print](#)

### A Board - 20" x 30"

Document Size: 20.4" x 30.4" (Includes Bleeds)  
Finished Size: 20" x 30" (508 x 762 mm) [Print](#)

### A Board - 22" x 28"

Document Size: 22.4" x 28.4" (Includes Bleeds)  
Finished Size: 22" x 28" (558.8 x 711.2 mm)

### A Board - 30" x 40"

Document Size: 30.4" x 40.4" (Includes Bleeds)  
Finished Size: 30" x 40" (762 x 1016 mm) [Print](#)





# INSTALLATION INSTRUCTIONS

## A Board / 1001882

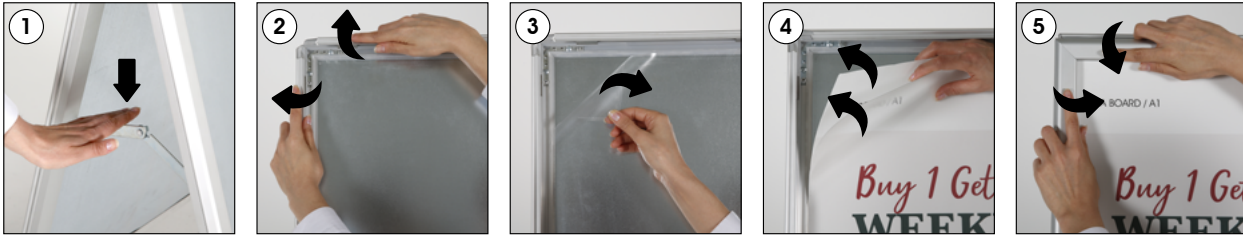

### Optional Header & Header Holder

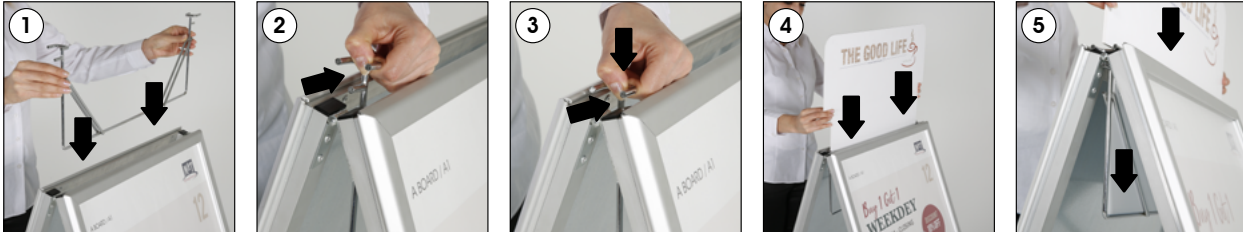

### Optional Basket

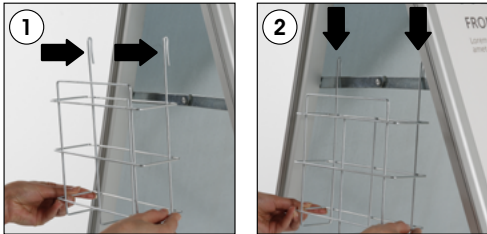

Note: Wire header holder, PVC Foam header and baskets are optional.



- Please inform the order number on the product or on the carton (e.g. 1/110001394-460) to the place that you have made the purchase if any problem with the product occurs.
- All rights reserved. All pictures, figures and writings are secured internationally by copy-right law. Infringements will be sued by civil and legal law.

This technical sheet's contents are all subject to update and modification at MT Displays' exclusive discretion. There is nothing official about this document. For final and legally binding information, please get in touch with the sales staff at MT Displays.



T: +90 850 433 67 85 / info@mtdisplays.com / www.mtdisplays.com