

ADJUSTABLE MENUBOARD



ECONOMIC FLOOR STANDS FOR YOUR MENUS, PROMOTIONS AND NOTES

The adjustable single-faced and double-faced menuboards are economic floor stands that can hold up to 3 frames both sided at once. They are easily adjustable to the eye level and suitable for various poster sizes in portrait or landscape options. The decorative base provides an elegant look. The items presented in the sizes A4 and A3 are suitable for portrait & landscape positions. A4 P/L Adjustable menuboard, round corners, max. height 1300mm. A3 P/L Adjustable menuboard, round corners, max. height 1500mm.

KEY SELECTION ATTRIBUTES

- * Adjustable Menuboard, made of aluminium profiles.
- * Ideal for use as single-faced and double-faced floor stand.
- * One set includes a durable base, a double channel body and a snap-open frame with anti-reflex PET poster cover, additional shelves are not included, should be ordered separately.
- * One menuboard with two positions as Landscape & Portrait.
- * Easily adjustable to the eye level, can hold up to 3 frames both sided at once.
- * Additional snap frames, leaflet dispensers and metal shelves can be used with the product.

- * Suitable for various poster sizes including A3 and A4.
- * Natural silver-anodized and various RAL colors available with antimicrobial powder coating.
- * The decorative base provides an elegant look.
- * Packed unassembled in a sturdy box.



COLOURS IN STOCK

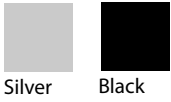

Silver Black

COLOUR OPTIONS

Black Anodised

Silver Anodised

White - RAL 9003

Black - RAL 9005

Red - RAL 3020

Blue - RAL 5002

Green - RAL 6029

Yellow - RAL 1021

CORNER TYPES

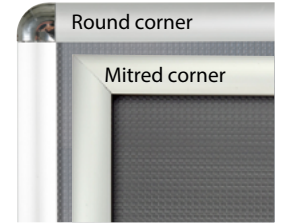

WATCH VIDEO



Watch video at our website
www.mtdisplays.com

SUITABLE FOR

Menuboards can be used for INDOOR applications, for signage needs in many locations like shopping centers, markets, groceries, hotels, offices airports, shops and stores, hospitals, schools, apartments and many more.

FEATURES



EXPLODED VIEW

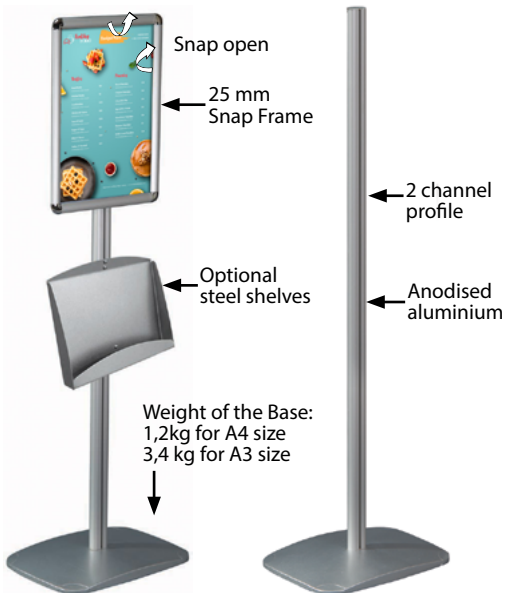

TECHNICAL DRAWING

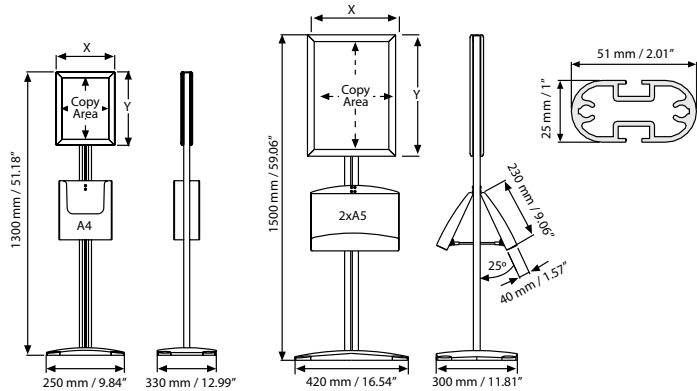

Some possible variations

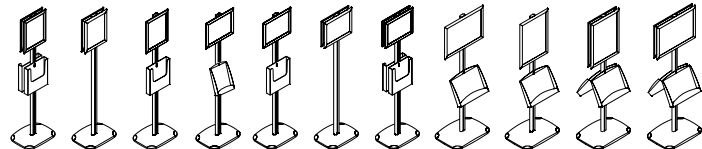

ARTICLES

MITRED ARTICLE	ROUND ARTICLE	EXTERNAL (x-y)	POSTER	COPY	WEIGHT	PACKING SIZE
					WITH PACKING	*W X H X D
UDMB1005A4	UDMB1000A4	239 X 326 mm	210 X 297 mm	192 X 279 mm	4,250 kg	320 X 1360 X 50 mm
UDMB1005A3	UDMB1000A3	327 X 450 mm	297 X 420 mm	279 X 402 mm	7,400 kg	380 X 1560 X 50 mm
UDMB100581	UDMB100081	9.68" X 12.18"	8.5" X 11"	7.79" X 10.29"	9.369 lbs	12.80" X 51.18" X 1.77"
UDMB100517	UDMB100017	12.18" X 18.18"	11" X 17"	10.29" X 16.29"	14.330 lbs	12.80" X 58.66" X 1.77"

OPTIONAL ACCESSORIES



2x A5 Steel shelf for Free Standing Leaflet & Adjustable menuboard.
UFSL002100



2x A5 Acrylic shelf for Free Standing Leaflet & Adjustable menuboard.
UFSL003100



1x A4 Steel shelf for Free Standing Leaflet.
UFSL002200



1x A4 Acrylic shelf for Free Standing Leaflet.
UFSL003200



1x A4 Acrylic shelf for Free Standing.
UFSL003300



T: +90 850 433 67 85 / info@mtdisplays.com / www.mtdisplays.com

PHYSICAL DATA

Material

25x51mm double channel aluminium ellipse profile body, snap-open aluminium profile frame, PET anti-reflex poster cover, PS backing or ABS backing. Steel or acrylic optional shelves.

Poster Material & Thickness

0,10 – 0,20 mm for standard product. Max poster thickness 2 mm for mitred corner, 1 mm for round corner. Any non-standard poster thicknesses should be indicated with order.

Surface Finish

Silver anodized or black colour, antimicrobial powder coating. Custom colors also available, call for custom color requests.

Recycled Content

Up to 78% recycled content used.

Warranty

All products are guaranteed for 3 years by MT Displays with below conditions:
[Warranty Conditions](#)

Installation Considerations

Menuboards are packed unassembled in a sturdy box with an easy-to-understand instruction sheet & fixing elements. One set includes a stable heavy base, a double channel body and a snap-open frame, additional snap frames, leaflet dispensers and metal shelves should be ordered separately.

Storage Conditions

Goods should be stored at 0° to 25°C in a dry place. Store in the original package.

Design Considerations

Suitable for silk screen printing, max. letter height is 15 mm. Suitable for various poster sizes including A3 and A4 in Landscape and Portrait positions. Easily adjustable to the eye level, can hold up to 3 frames both sided at once. The decorative base provides an elegant look.

Cleaning and Disinfecting

Clean your displays, with damp microfiber clothes, rinsed with simply water or warm, soapy or gentle shampooed water. Avoid using vinegar, abrasive, acidic, alcohol-based or heavy cleaners or cleaners containing Ammonia. Only after cleaning the product, if needed, simply apply disinfectant or sanitizer that is in compliance with your local guidelines and regulations.

PRINT TEMPLATES

Adjustable Menuboard - A4

Document Size: 220 x 307 mm (Includes Bleeds)
 Finished Size: A4 (210 x 297 mm)

Adjustable Menuboard - A3

Document Size: 307 x 430 mm (Includes Bleeds)
 Finished Size: A3 (297 x 420 mm)

Adjustable Menuboard - 8.5"x11"

Document Size: 8.89" x 11.4" (Includes Bleeds)
 Finished Size: 8.5" x 11" (279.4 x 431.8 mm)

Adjustable Menuboard - 11"x17"

Document Size: 11.4" x 17.4" (Includes Bleeds)
 Finished Size: 11" x 17" (279.4 x 431.8 mm)

INSTALLATION INSTRUCTIONS

Adjustable Menuboard / 1001985

Each product includes

- 1 x Main body profile
- 1 x Base
- 1 x Snap Frame
- 1 x PET cover
- 1 x 4 allen key
- 2 x Bolt M4x12
- 2 x Bolt M6x50
- 2 x Nut M4

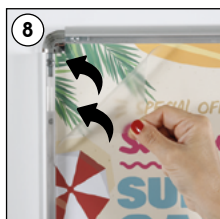
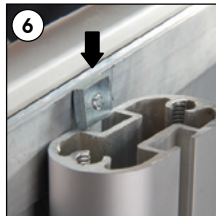
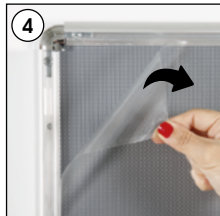
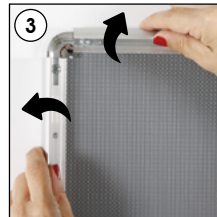
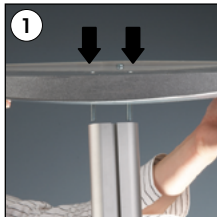

- Please inform the order number on the product or on the carton (e.g. 1/110001394-460) to the place that you have made the purchase if any problem with the product occurs.
- All rights reserved. All pictures, figures and writings are secured internationally by copy-right law. Infringements will be sued by civil and legal law.

This technical sheet's contents are all subject to update and modification at MT Displays' exclusive discretion. There is nothing official about this document. For final and legally binding information, please get in touch with the sales staff at MT Displays.



T: +90 850 433 67 85 / info@mtdisplays.com / www.mtdisplays.com