

ART EASEL



EASEL WITH TOP CLAMP FOR YOUR ADS, MENU ITEMS, PROMOTIONS AND NOTES

Made of Beechwood, Easel is a solid product for commercial use. Adjustable easel accommodates varying canvas sizes. It is made to be sturdy, strong, and will last in retail settings. Adjustable back support ensures stability of the easel and comfortable use at different angles. With a lipped bottom shelf and secure top clamp, the easel will hold your artwork firmly in place. It folds flat for storage.

KEY SELECTION ATTRIBUTES

- * Art Easel, made of Beech Wood.
- * Made to be sturdy, strong and long lasting for commercial use, especially in retail settings.
- * Ideal for presenting, ads, menus, promotions, messages and notes. as well as arts and crafts
- * Perfect way to present/change the posters/ messages on a shelf.
- * One set includes wooden parts of whole body and various hardware parts for joining.
- * Paper Clamp on the top for presenting papers.
- * Optional accessories like magnetic glassboards or opti-frames are not included.
- * You can adjust height and angle of easel for accommodating various canvas sizes: B2 up to A0.
- * Adjustable back support ensures comfortable use at different angles.
- * Easy to fold flat for easy storage.
- * Packed unassembled in one box.
- * All instructions, parts and tools are included.

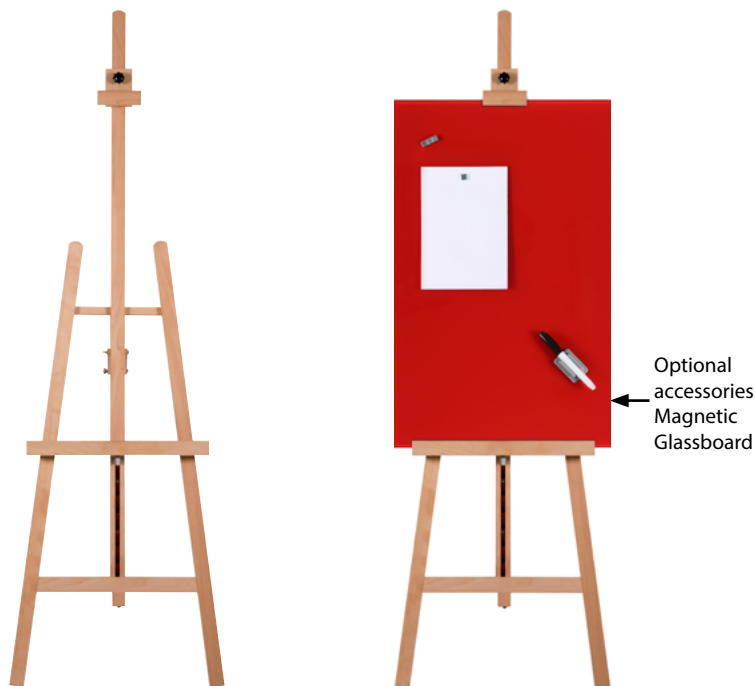

SUITABLE FOR

Art Easels can be used for INDOOR applications, for signage needs in many locations like shopping centers, markets, groceries, hotels, offices airports, shops and stores, hospitals, and many more. It is ideal for art galleries to display art materials.

WATCH VIDEO FEATURES



Watch video at our website www.mtdisplays.com

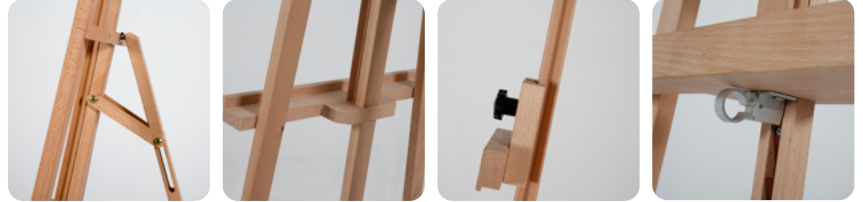

EXPLODED VIEW

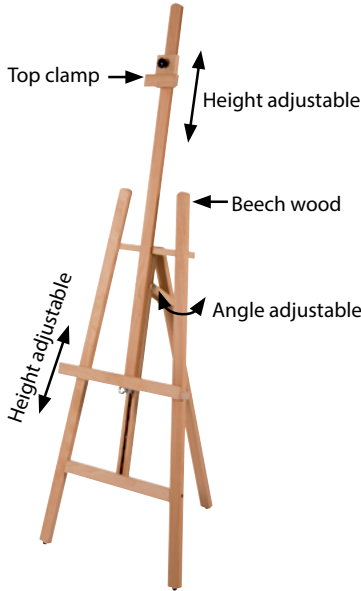

TECHNICAL DRAWING

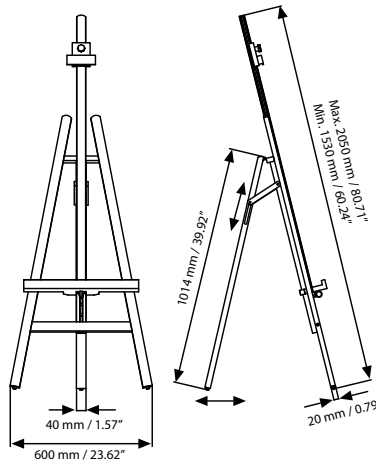

ARTICLES

ARTICLE	SIZE	WEIGHT	PACKING SIZE
		WITH PACKING	*W X H X D
USLM000015	600 X 790 X 1480 mm	5,000 kg	115 X 1530 X 75 mm

OPTIONAL ACCESSORIES



Colour chalkboard marker. 10 mm wide. 5 Pcs. / UYAKLM1251



White chalkboard marker for Wood Display. 10 mm wide. 3 Pcs. / UYAKLM1250



Opti Frame 25 mm A2, A1, A0, B2, B1, B0, 22"x28", 20"x30", 24"x36", 30"x40"



Snap Frame 25 mm A2, A1, A0, B2, B1, B0, 22"x28", 20"x30", 24"x36", 30"x40"



Magnetic Glassboard. Black, Red, White colours. 400x600 mm, 600x900 mm

PHYSICAL DATA

Material
Easel, made of Beech Wood.

Surface Finish
Natural Wood.

Recycled Content
N/A

Warranty
All products are guaranteed for 3 years by MT Displays with below conditions:
[Warranty Conditions](#)

Storage Conditions
Goods should be stored at 0° to 25°C in a dry place. Store in the original package.

Poster Material & Thickness
An easel with a shelf and topl clamp is perfect for use with accessories like opti-frames, magnetic glassboards or chalkboard panels.

Design Considerations
Made to be sturdy, strong and long lasting for

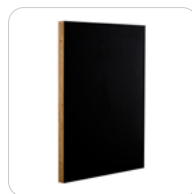

Frameless Frame. 400x600 mm, 600x900 mm, 600x800 mm.

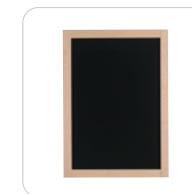

Easy Wood Frame. Natural wood, Dark wood. 480x680 mm, 680x980 mm, 680x880 mm.

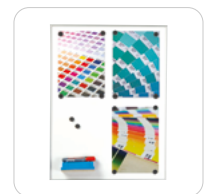

Frameboard 9 mm Cork, Magnetic, M&C 4xA4, 6xA4

commercial use, especially in retail settings. You can adjust the height and angle of easel for accomodating various canvas sizes: B2 up to A0.

Installation Considerations
Packed unassembled in a sturdy box with an easy to understand instruction. One set includes wooden parts of whole body and various hardware parts for joining. Paper Clamp on the top for presenting papers. Comes with magnetic buttons and eraser. Assembly in a short time. Adjustable back support ensures comfortable use at different angles. Easy to move and stabilize

by lockable casters. Easy to fold flat for easy storage. Please order the frame accessories separately.

Cleaning and Disinfecting
Clean your displays, with damp microfiber clothes, rinsed with simply water or warm, soapy or gentle shampooed water. Avoid using vinegar, abrasive, acidic, alcohol-based or heavy cleaners or cleaners containing Ammonia. Only after cleaning the product, if needed, simply apply disinfectant or sanitizer that is in compliance with your local guidelines and regulations.



T: +90 850 433 67 85 / info@mtdisplays.com / www.mtdisplays.com

INSTALLATION INSTRUCTIONS

Art Easel / 1010255H000

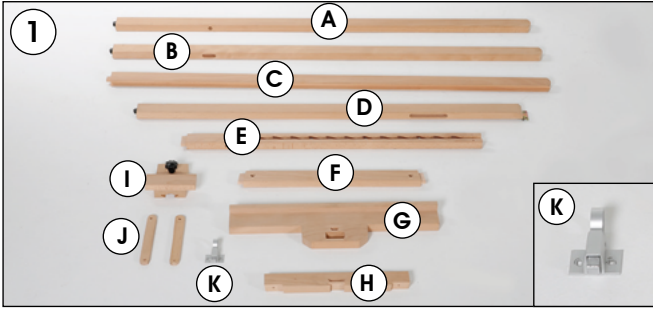

PARTS LIST

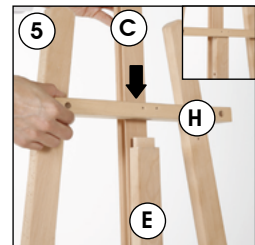
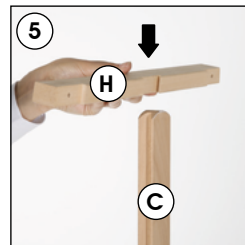
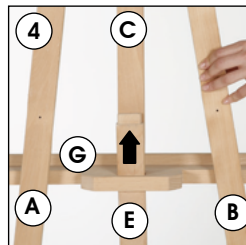
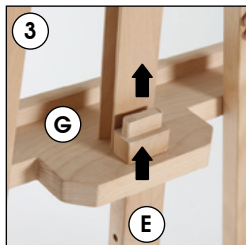
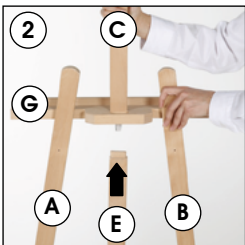
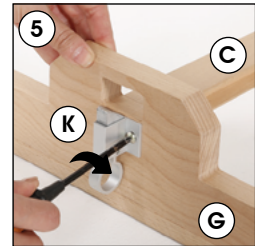
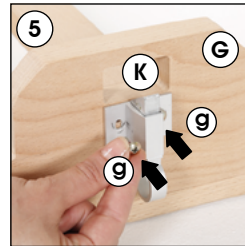
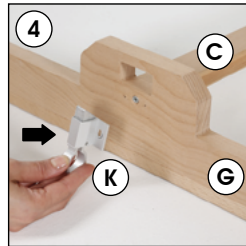
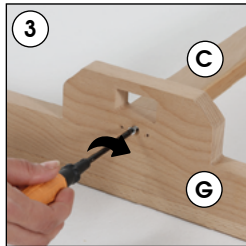
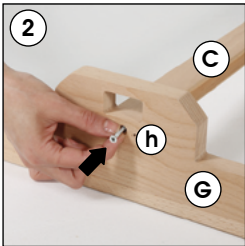
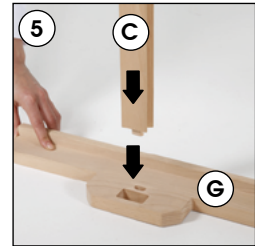
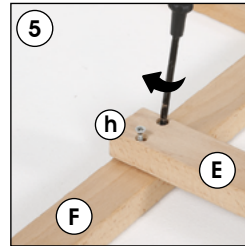
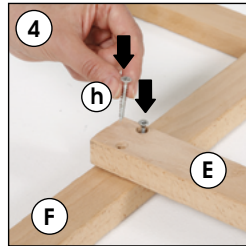
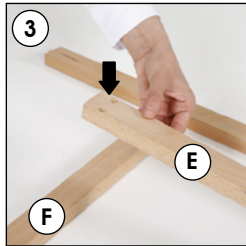
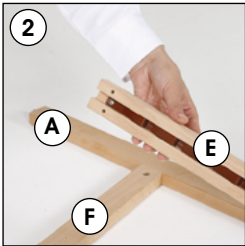
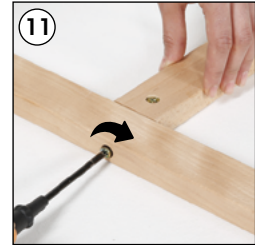
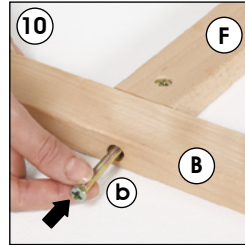
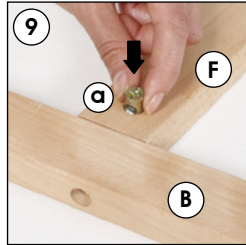
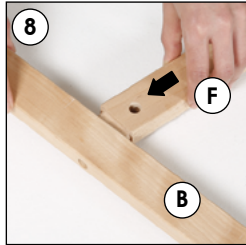
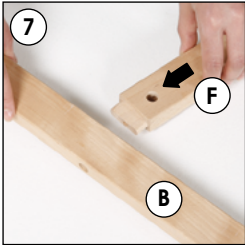
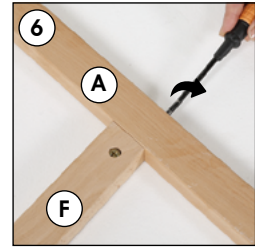
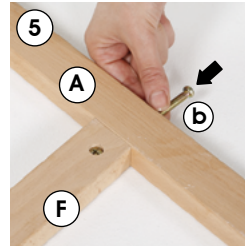
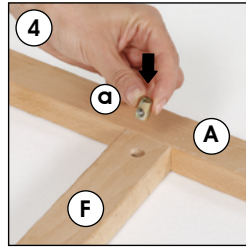
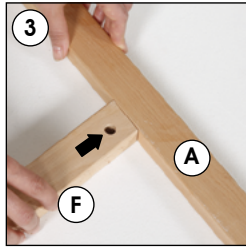
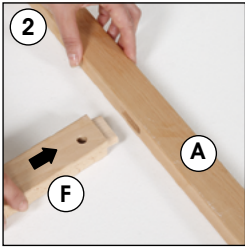
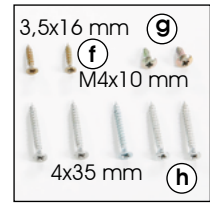
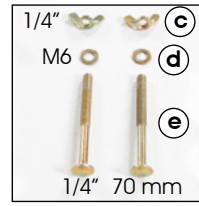
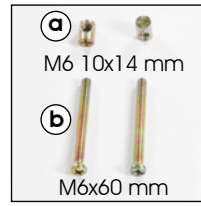

• Please inform the order number on the product or on the carton (e.g. 1/110001394-460) to the place that you have made the purchase if any problem with the product occurs.

• All rights reserved. All pictures, figures and writings are secured internationally by copy-right law. Infringements will be sued by civil and legal law.

This technical sheet's contents are all subject to update and modification at MT Displays' exclusive discretion. There is nothing official about this document. For final and legally binding information, please get in touch with the sales staff at MT Displays.



T: +90 850 433 67 85 / info@mtdisplays.com / www.mtdisplays.com