

## BASIC EASEL



## ECONOMIC SOLUTION FOR PRESENTING YOUR ADS, MENU ITEMS, PROMOTIONS AND NOTES

Basic Easel is made of pine wood which is one of the most strongest woods used for furniture. Basic Easel is an economic solution for many type of business. Capacity adjustable easel accommodates varying canvas sizes. It is made to be sturdy, strong, and will last in retail settings. Adjustable back support and chain ensures stability of the easel and comfortable use at different angles. It folds flat for easy storage.

### KEY SELECTION ATTRIBUTES

- \* Basic Easel is an economic solution, made of pine Wood, one of the most strongest woods.
- \* Made to be sturdy, strong and long lasting for many type of businesses like retail.
- \* Ideal for presenting, ads, menus, promotions, messages and notes.
- \* Easy to present/change the posters/messages on a shelf.
- \* One set includes wooden parts of whole body and various hardware parts for assembly.
- \* Optional accessories like magnetic glassboards or opti-frames are not included.
- \* You can adjust height of easel for accomodating various canvas sizes: B2 up to A0.
- \* Adjustable back support and chain ensures stability and comfortable use at different angles.
- \* 3 different display height options.
- \* Easy to fold flat for easy storage.
- \* Packed unassembled in a one box.



## COLOURS IN STOCK



Natural Wood    Dark Wood

## SUITABLE FOR

Basic Easel can be used for INDOOR applications, for signage needs in many locations like shopping centers, markets, groceries, hotels, offices airports, shops and stores, hospitals, schools, apartments and many more. Especially when the advertisement needs to change often, Basic easel is an ideal solution.

## WATCH VIDEO



Watch video at our website  
www.mtdisplays.com

## FEATURES



## EXPLODED VIEW

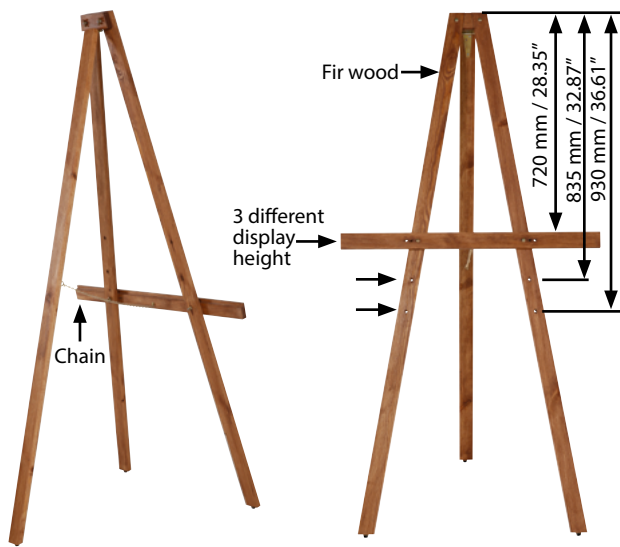

## TECHNICAL DRAWING

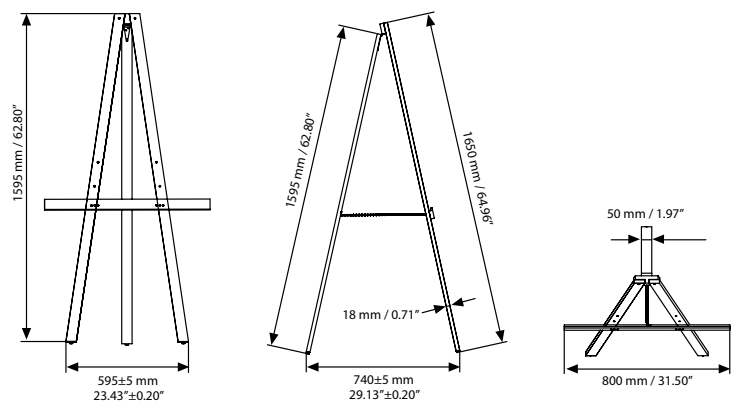

## ARTICLES

ARTICLE	SIZE (x-y)	DESCRIPTION	WEIGHT	PACKING SIZE
			WITH PACKING	*W X H X D
USLBN00016	595 X 740 mm	Natural Wood	5,00 kg	155 X 1720 X 80 mm
USLBD00016	595 X 740 mm	Dark Wood	5,00 kg	155 X 1720 X 80 mm

## OPTIONAL ACCESSORIES



Colour chalkboard marker. 10 mm wide. 5 Pcs. / UYAKLM1251



White chalkboard marker for Wood Display. 10 mm wide. 3 Pcs / UYAKLM1250



Opti Frame 25 mm  
A2, A1, A0, B2, B1, B0, 22"x28", 20"x30", 24"x36", 30"x40"



Snap Frame 25 mm  
A2, A1, A0, B2, B1, B0, 22"x28", 20"x30", 24"x36", 30"x40"



Magnetic Glassboard. Black, Red, White colours. 400x600 mm, 600x900 mm



Frameless Frame. 400x600 mm, 600x900 mm, 600x800 mm.

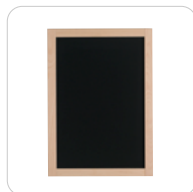

Easy Wood Frame. Natural wood, Dark wood. 480x680 mm, 680x980 mm, 680x880 mm.

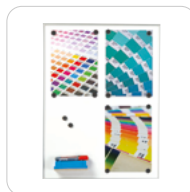

Frameboard 9 mm  
Cork, Magnetic, M&C  
4xA4, 6xA4



CHALKBOARD PANEL  
UYPBAD1010  
UYPBAD1020



T: +90 850 433 67 85 / info@mtdisplays.com / www.mtdisplays.com

# PHYSICAL DATA

## Material

Easel, made of pine Wood, one of the most strongest woods.

## Recycled Content

N/A

## Surface Finish

Dark Wood with lacquered finish. Natural wood natural finish

## Warranty

All products are guaranteed for 1 years by MT Displays with below conditions:

[Warranty Conditions](#)

## Storage Conditions

Goods should be stored at 0° to 25°C in a dry place. Store in the original package.

## Design Considerations

Made to be sturdy, strong and long lasting for many type of businesses like retail. You can adjust height of easel with 3 different display height options, for accomodating various canvas sizes: B2 up to A0.

## Poster Material & Thickness

A modern easel with a shelf is perfect for use with accessories like opti-frames, magnetic glassboards or chalkboard panels.

## Cleaning and Disinfecting

Clean your displays, with damp microfiber clothes,

rinsed with simply water or warm, soapy or gentle shampooed water. Avoid using vinegar, abrasive, acidic, alcohol-based or heavy cleaners or cleaners containing Ammonia. Only after cleaning the product, if needed, simply apply disinfectant or sanitizer that is in compliance with your local guidelines and regulations.

## Installation Considerations

Packed unassembled in a sturdy box with an easy to understand instruction. One set includes wooden parts of whole body and various hardware parts for joining. Assembly in a short time. Adjustable back support and chain ensures stability and comfortable use at different angles. Easy to fold flat for easy storage. Please order the frame accessories seperately.

# INSTALLATION INSTRUCTIONS

## Basic Easel / 1011036H000

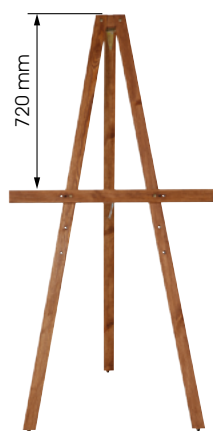
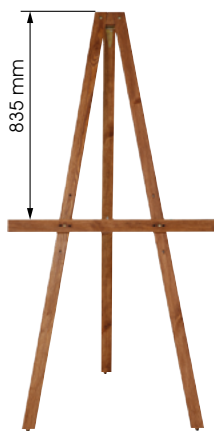
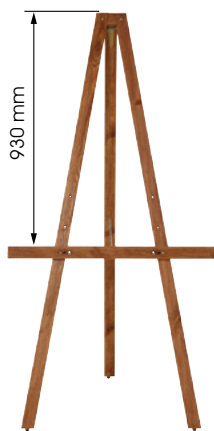
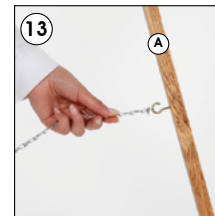
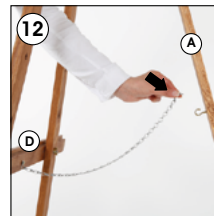
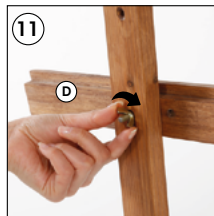
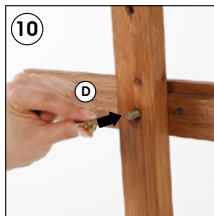
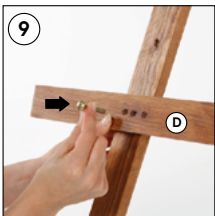
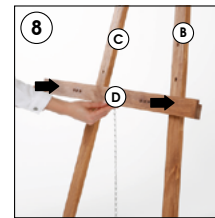
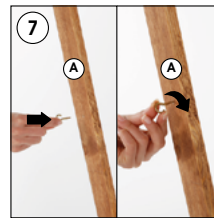
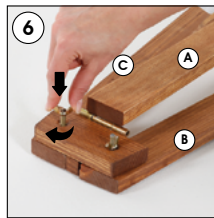
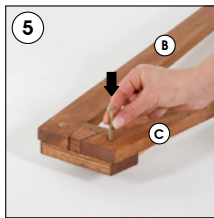
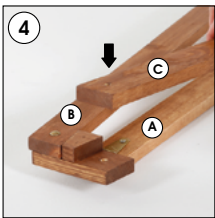
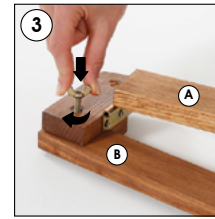
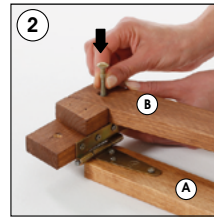
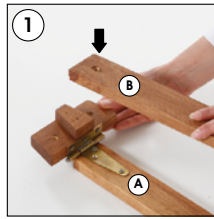
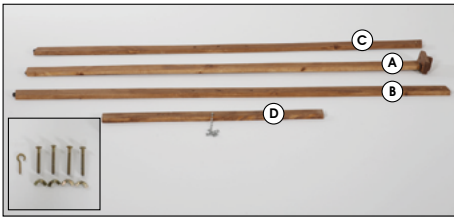

- Please inform the order number on the product or on the carton (e.g. 1/110001394-460) to the place that you have made the purchase if any problem with the product occurs.
- All rights reserved. All pictures, figures and writings are secured internationally by copy-right law. Infringements will be sued by civil and legal law.

This technical sheet's contents are all subject to update and modification at MT Displays' exclusive discretion. There is nothing official about this document. For final and legally binding information, please get in touch with the sales staff at MT Displays.



T: +90 850 433 67 85 / info@mtdisplays.com / www.mtdisplays.com