

CURVED MENUBOARD NEW COLOURS



MULTIFUNCTIONAL MENUBOARD FOR FREQUENTED TRAFFIC AREAS

Stylish Curved Menuboard captures the customers attention in all frequented traffic areas. The Curved Menuboard is suitable for use in hotels, galleries, museums, restaurants, lobby, bars, etc.. It is available in A4 and A3 portrait and landscape positions. With modern and fashionable colours, it is suitable for in front of cars in a car showroom, exhibition grounds, museums, hotel or restaurant halls, etc.

KEY SELECTION ATTRIBUTES

- * Curved Menuboard with optional brochure holder.
- * Suitable for poster sizes A3 and A4 in portrait and landscape positions.
- * One set includes a powder coated heavy base, aluminium profile curved body and a snap-open poster frame with a sight angle that catches the eye level.

- * Modern and fashionable colors available with antimicrobial powder coating.
- * Heavy elegant base provides stability.
- * Packed unassembled in a sturdy box.



One product,
two positions
(landscape&portrait)

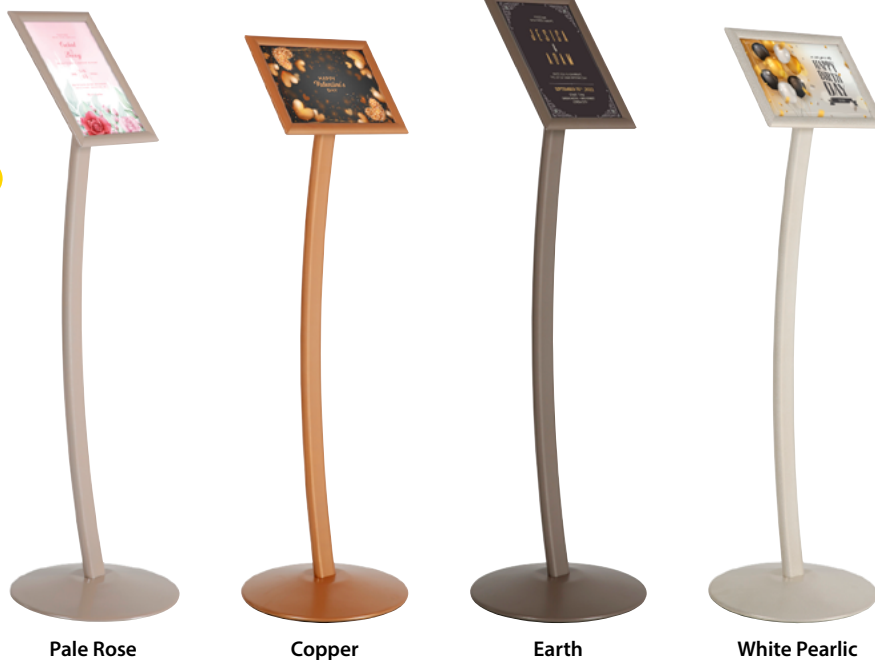

Pale Rose

Copper

Earth

White Pearllic



COLOURS IN STOCK



SUITABLE FOR

Menuboards can be used for INDOOR applications, for signage needs in many locations like shopping centers, markets, groceries, hotels, offices airports, shops and stores, hospitals, schools, apartments and many more.

WATCH VIDEO



Watch video at our website
www.mtdisplays.com

FEATURES



EXPLODED VIEW

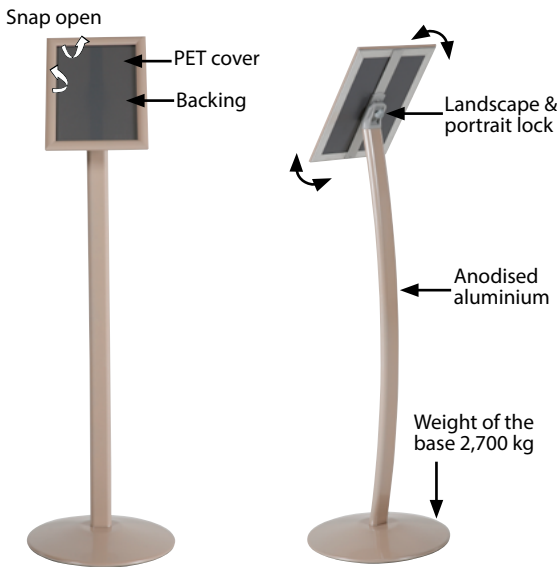

TECHNICAL DRAWING

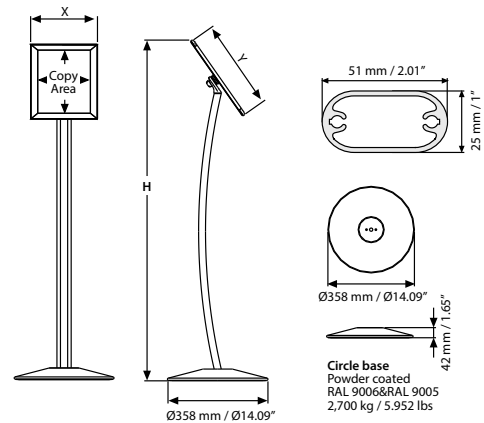

ARTICLES

ARTICLE	EXTERNAL (x-y)	POSTER	COPY	HEIGHT	DESCRIPTION	WEIGHT	PACKING SIZE
						WITH PACKING	*W X H X D
UCUMB105A4	240 X 327mm	210 X 297 mm	192 X 279 mm	1212 mm	Copper - A4 portrait	4,050 kg	470 X 1100 X 67 mm
				1176 mm	Copper - A4 landscape		
UCUMB105A3	327 X 450 mm	297 X 420 mm	279 X 402 mm	1262 mm	Copper - A3 portrait	4,350 kg	470 X 1100 X 67 mm
				1212 mm	Copper - A3 landscape		
UCUMB205A4	240 X 327mm	210 X 297 mm	192 X 279 mm	1212 mm	White Pearllic - A4 portrait	4,050 kg	470 X 1100 X 67 mm
				1176 mm	White Pearllic - A4 landscape		
UCUMB205A3	327 X 450 mm	297 X 420 mm	279 X 402 mm	1262 mm	White Pearllic - A3 portrait	4,350 kg	470 X 1100 X 67 mm
				1212 mm	White Pearllic - A3 landscape		
UCUMB305A4	240 X 327mm	210 X 297 mm	192 X 279 mm	1212 mm	Earth - A4 portrait	4,050 kg	470 X 1100 X 67 mm
				1176 mm	Earth - A4 landscape		
UCUMB305A3	327 X 450 mm	297 X 420 mm	279 X 402 mm	1262 mm	Earth - A3 portrait	4,350 kg	470 X 1100 X 67 mm
				1212 mm	Earth - A3 landscape		
UCUMB405A4	240 X 327mm	210 X 297 mm	192 X 279 mm	1212 mm	Rose - A4 portrait	4,050 kg	470 X 1100 X 67 mm
				1176 mm	Rose - A4 landscape		
UCUMB405A3	327 X 450 mm	297 X 420 mm	279 X 402 mm	1262 mm	Rose - A3 portrait	4,350 kg	470 X 1100 X 67 mm
				1212 mm	Rose - A3 landscape		



T: +90 850 433 67 85 / info@mtdisplays.com / www.mtdisplays.com

ARTICLES

ARTICLE	EXTERNAL (x-y)	POSTER	COPY	HEIGHT	DESCRIPTION	WEIGHT	PACKING SIZE
						WITH PACKING	*W X H X D
UCUMB10581	9.68" X 12.18"	8.5" X 11"	7.79" X 10.29"	47.72"	Copper - 8.5"X11" portrait	12.169 lbs	20.67" X 52.36" X 4.06"
				46.30"	Copper - 8.5"X11" landscape		
UCUMB10517	12.18" X 18.18"	11" X 17"	10.29" X 16.29"	49.69"	Copper - 11"X17" portrait	12.389 lbs	14.37" X 43.70" X 4.02"
				47.72"	Copper - 11"X17" landscape		
UCUMB20581	9.68" X 12.18"	8.5" X 11"	7.79" X 10.29"	47.72"	White Pearllic - 8.5"X11" portrait	12.169 lbs	20.67" X 52.36" X 4.06"
				46.30"	White Pearllic - 8.5"X11" landscape		
UCUMB20517	12.18" X 18.18"	11" X 17"	10.29" X 16.29"	49.69"	White Pearllic - 11"X17" portrait	12.389 lbs	14.37" X 43.70" X 4.02"
				47.72"	White Pearllic - 11"X17" landscape		
UCUMB30581	9.68" X 12.18"	8.5" X 11"	7.79" X 10.29"	47.72"	Earth - 8.5"X11" portrait	12.169 lbs	20.67" X 52.36" X 4.06"
				46.30"	Earth - 8.5"X11" landscape		
UCUMB30517	12.18" X 18.18"	11" X 17"	10.29" X 16.29"	49.69"	Earth - 11"X17" portrait	12.389 lbs	14.37" X 43.70" X 4.02"
				47.72"	Earth - 11"X17" landscape		
UCUMB40581	9.68" X 12.18"	8.5" X 11"	7.79" X 10.29"	47.72"	Rose - 8.5"X11" portrait	12.169 lbs	20.67" X 52.36" X 4.06"
				46.30"	Rose - 8.5"X11" landscape		
UCUMB40517	12.18" X 18.18"	11" X 17"	10.29" X 16.29"	49.69"	Rose - 11"X17" portrait	12.389 lbs	14.37" X 43.70" X 4.02"
				47.72"	Rose - 11"X17" landscape		

OPTIONAL ACCESSORIES



Adapter for A4 Brochure Holder (30 Pcs) / UYPMBH00A4
Adapter for A5 Brochure Holder (45 Pcs) / UYPMBH00A5



A4 Brochure Holder (30 Pcs) UMSDMB00A4



A5 Brochure Holder (45 Pcs) UMSDMB00A5

PHYSICAL DATA

Material

25x51mm aluminium ellipse profile curved body, snap-open aluminium profile poster frame, PET anti-reflex poster cover, PS backing or ABS backing. Acrylic optional shelves.

Poster Material & Thickness

0,10 – 0,20 mm for standard product. Max poster thickness 2 mm for mitred corner, 1 mm for round corner. Any non-standard poster thicknesses should be indicated with order.

Surface Finish

Pearlic special colours,, antimicrobial powder coating. Custom colors also available, call for custom color requests.

Recycled Content

Up to 78% recycled content used.

Warranty

All products are guaranteed for 3 years by MT Displays with below conditions:

[Warranty Conditions](#)

Installation Considerations

Menuboards are packed unassembled in a sturdy box with an easy-to-understand instruction sheet & fixing elements. Assembly in 60 seconds. One set includes a powder coated heavy base, aluminium profile curved body and a snap-open poster frame with a sight angle that catches the eye level. Optional brochure holder and adapter should be ordered seperately. When the nut on the back of frame is loose, frame can be placed in either portrait or landscape position.

Storage Conditions

Goods should be stored at 0° to 25°C in a dry place. Store in the original package.

Design Considerations

Special colours for a modern and fashionable look. Suitable for silk screen printing, max. letter height is 15 mm. Suitable for A3 and A4 poster sizes in Landscape and Portrait positions with a sight angle that catches the eye level. The heavy elegant base provides stability.

Cleaning and Disinfecting

Clean your displays, with damp microfiber clothes, rinsed with simply water or warm, soapy or gentle shampooed water. Avoid using vinegar, abrasive, acidic, alcohol-based or heavy cleaners or cleaners containing Ammonia. Only after cleaning the product, if needed, simply apply disinfectant or sanitizer that is in compliance with your local guidelines and regulations.

PRINT TEMPLATES

Curved Menuboard New Colours - A4

Document Size: 220 x 307 mm (Includes Bleeds)
Finished Size: A4 (210 x 297 mm) [Print](#)

Curved Menuboard New Colours - A3

Document Size: 307 x 430 mm (Includes Bleeds)
Finished Size: A3 (297 x 420 mm) [Print](#)

Curved Menuboard New Colours - 8.5"x11"

Document Size: 8.89" x 11.4" (Includes Bleeds)
Finished Size: 8.5" x 11" (279.4 x 431.8 mm)

Curved Menuboard New Colours - 11"x17"

Document Size: 11.4" x 17.4" (Includes Bleeds)
Finished Size: 11" x 17" (279.4 x 431.8 mm)



INSTALLATION INSTRUCTIONS

Curved Menubard / 1004950

Each product includes

- 1 x Frame
- 1 x Base
- 1 x Main body
- 1 x 5 allen key
- 2 x Bolt M6x25

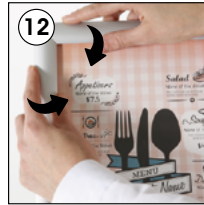
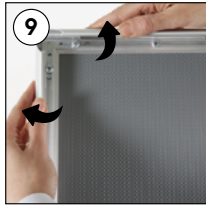
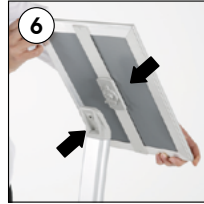
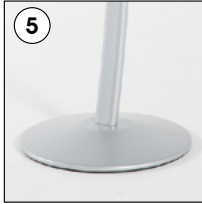
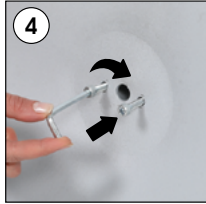
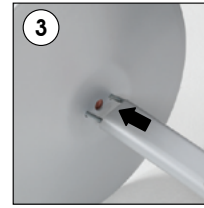
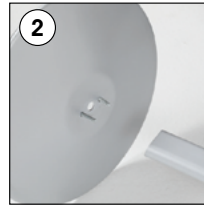
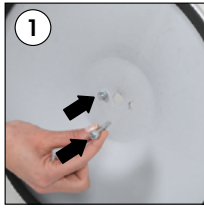
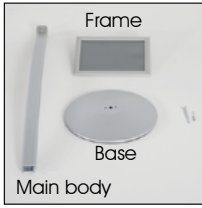

Portrait
Hochformat

Landscape
Querformat

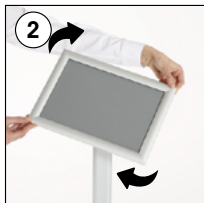

- Please inform the order number on the product or on the carton (e.g. 1/110001394-460) to the place that you have made the purchase if any problem with the product occurs.
- All rights reserved. All pictures, figures and writings are secured internationally by copy-right law. Infringements will be sued by civil and legal law.

This technical sheet's contents are all subject to update and modification at MT Displays' exclusive discretion. There is nothing official about this document. For final and legally binding information, please get in touch with the sales staff at MT Displays.



T: +90 850 433 67 85 / info@mtdisplays.com / www.mtdisplays.com