

CURVED MENUBOARDS



PRACTICAL & EASY MENUBOARD FOR FREQUENTED TRAFFIC AREAS

The Curved Menuboard has both a silver & a black finish. Our new stylish Curved Menuboard captures the customers attention in all frequented traffic areas. The Curved Menuboard is suitable for use in hotels, galleries, museums, restaurants, lobby, bars, etc.. It is available in A4 and A3 portrait and landscape positions.

KEY SELECTION ATTRIBUTES

- * Curved Menuboard with optional brochure holder.
- * Suitable for poster sizes A3 and A4 in portrait and landscape positions.
- * One set includes a powder coated heavy base, aluminium profile curved body and a snap-open poster frame with a sight angle that catches the eye level.

- * Natural silver-anodized, black and various RAL colors available with antimicrobial powder coating.
- * Heavy elegant base provides stability.
- * Packed unassembled in a sturdy box.



Silver, Round Corner

Black, Mitred Corner



COLOURS IN STOCK

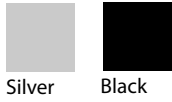

Silver Black

COLOUR OPTIONS

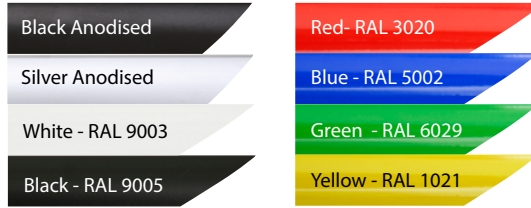

CORNER TYPES

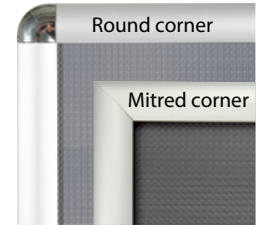

SUITABLE FOR

Menuboard can be used for INDOOR applications, for signage needs in many locations like shopping centers, markets, groceries, hotels, offices airports, shops and stores, hospitals, schools, apartments and many more.

WATCH VIDEO FEATURES



Watch video at our website www.mtdisplays.com



EXPLODED VIEW

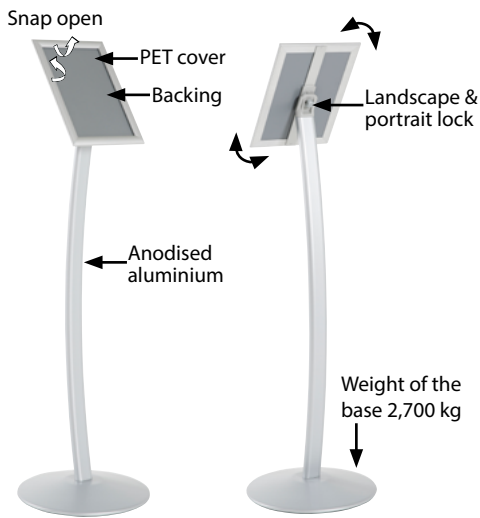

TECHNICAL DRAWING

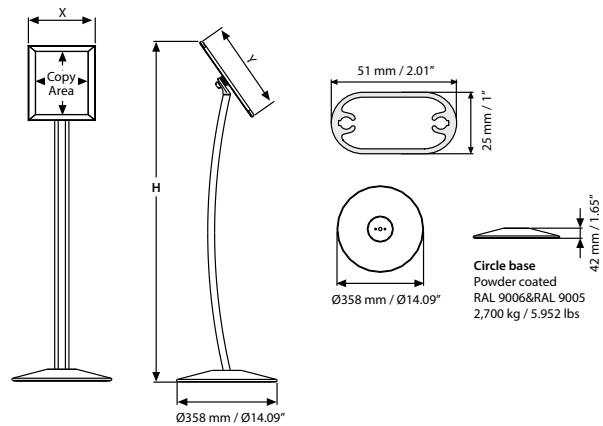

ARTICLES

SILVER MITRED	SILVER ROUND	BLACK MITRED	EXTERNAL (x-y)	POSTER	COPY	HEIGHT	DESCRIPTION	WEIGHT	PACKING SIZE
								WITH PACKING	*W X H X D
UCUMBN05A4	UCUMBN00A4	UCUMBB05A4	240 X 327 mm	210 X 297 mm	192 X 279 mm	1212 mm	A4 portrait	4,050 kg	470 X 1100 X 67 mm
						1176 mm	A4 landscape		
UCUMBN05A3	UCUMBN00A3	UCUMBB05A3	327 X 450 mm	297 X 420 mm	279 X 402 mm	1262 mm	A3 portrait	4,350 kg	470 X 1100 X 67 mm
						1212 mm	A3 landscape		
UCUMBN0581	UCUMBN0081	UCUMBB0581	9.68" X 12.18"	8.5" X 11"	7.79" X 10.29"	47.72"	Portrait	12.169 lbs	20.67" X 52.36" X 4.06"
						46.30"	Landscape		
UCUMBN0517	UCUMBN0017	UCUMBB0517	12.18" X 18.18"	11" X 17"	10.29" X 16.29"	49.69"	Portrait	12.389 lbs	14.37" X 43.70" X 4.02"
						47.72"	Landscape		
UCUMBN0512	UCUMBN0012	UCUMBB0512	19.18" X 23.18"	18" X 22"	17.29" X 21.29"	53.43"	Portrait	15.211 lbs	23.62" X 42.52" X 2.56"
						50.91"	Landscape		

OPTIONAL ACCESSORIES



Adapter for A4 Brochure Holder (30 Pcs) / UYPMBH00A4
Adapter for A5 Brochure Holder (45 Pcs) / UYPMBH00A5



A4 Brochure Holder (30 Pcs) UMSDMB00A4



A5 Brochure Holder (45 Pcs) UMSDMB00A5



T: +90 850 433 67 85 / info@mtdisplays.com / www.mtdisplays.com

PHYSICAL DATA

Material

25x51mm aluminium ellipse profile body, snap-open aluminium profile poster frame, PET anti-reflex poster cover, PS backing or ABS backing. Acrylic optional shelves.

Poster Material & Thickness

0,10 – 0,20 mm for standard product. Max poster thickness 2 mm for mitred corner, 1 mm for round corner. Any non-standard poster thicknesses should be indicated with order.

Surface Finish

Silver anodized or black colour, antimicrobial powder coating. Custom colors also available, call for custom color requests.

Recycled Content

Up to 78% recycled content used.

Warranty

All products are guaranteed for 3 years by MT Displays with below conditions:
[Warranty Conditions](#)

Installation Considerations

Menuboards are packed unassembled in a sturdy box with an easy-to-understand instruction sheet & fixing elements. One set includes a powder coated heavy base, aluminium profile body and a snap-open poster frame with a sight angle that catches the eye level. Optional brochure holder and adapter should be ordered separately. When the nut on the back of frame is loose, frame can be placed in either portrait or landscape position.

Storage Conditions

Goods should be stored at 0° to 25°C in a dry place. Store in the original package.

Design Considerations

Suitable for silk screen printing, max. letter height is 15 mm. Suitable for A3 and A4 poster sizes in Landscape and Portrait positions with a sight angle that catches the eye level. The heavy base provides stability.

Cleaning and Disinfecting

Clean your displays, with damp microfiber clothes, rinsed with simply water or warm, soapy or gentle shampooed water. Avoid using vinegar, abrasive, acidic, alcohol-based or heavy cleaners or cleaners containing Ammonia. Only after cleaning the product, if needed, simply apply disinfectant or sanitizer that is in compliance with your local guidelines and regulations.

PRINT TEMPLATES

Curved Menuboard - A4

Document Size: 220 x 307 mm (Includes Bleeds)
Finished Size: A4 (210 x 297 mm) [Print](#)

Curved Menuboard - A3

Document Size: 307 x 430 mm (Includes Bleeds)
Finished Size: A3 (297 x 420 mm) [Print](#)

Curved Menuboard - 8.5"x11"

Document Size: 8.89" x 11.4" (Includes Bleeds)
Finished Size: 8.5" x 11" (279.4 x 431.8 mm)

Curved Menuboard - 11"x17"

Document Size: 11.4" x 17.4" (Includes Bleeds)
Finished Size: 11" x 17" (279.4 x 431.8 mm)

Curved Menuboard - 18"x22"

Document Size: 18.4" x 22.4" (Includes Bleeds)
Finished Size: 18" x 22" (457.2 x 558.8 mm) [Print](#)

INSTALLATION INSTRUCTIONS

Curved Menuboard / 1004950

Each product includes

- 1 x Frame
- 1 x Base
- 1 x Main body
- 1 x 5 allen key
- 2 x Bolt M6x25

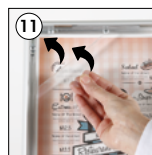
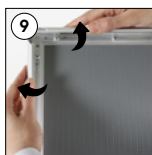
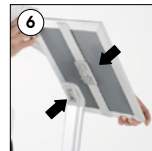
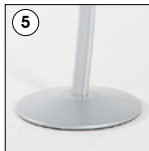
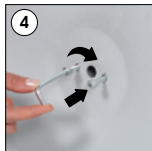
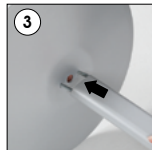
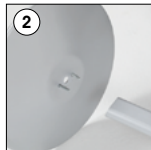
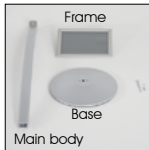

Portrait
hochformat



• Please inform the order number on the product or on the carton (e.g. 1/110001394-460) to the place that you have made the purchase if any problem with the product occurs.
• All rights reserved. All pictures, figures and writings are secured internationally by copy-right law. Infringements will be sued by civil and legal law.

This technical sheet's contents are all subject to update and modification at MT Displays' exclusive discretion. There is nothing official about this document. For final and legally binding information, please get in touch with the sales staff at MT Displays.



T: +90 850 433 67 85 / info@mtdisplays.com / www.mtdisplays.com