

## DECORATIVE MENUBOARD



### MENUBOARDS WITH VARIOUS ELEGANT DESIGN OPTIONS

The Menuboard with a sight angle that catches the eye level. The decorative base provides an elegant look. It is available in the sizes A4, A3 and A2 in portrait & landscape positions. The fixed height of the A4 model is 1000 mm. The height of the A3 model is 1200 mm.

### KEY SELECTION ATTRIBUTES

- \* Custom sizes options ranging from a minimum of A4 to a maximum of A2 landscape.
- \* Decorative Menuboard with various elegant design options.
- \* Suitable for poster sizes A2, A3 and A4 in portrait and landscape positions.
- \* One set includes a powder coated decorative heavy base, aluminium ellipse profile body and a snap-open or opti-poster frame with a sight angle that catches the eye level.

- \* Optional A5 or A4 acrylic brochure holder is not included, should be ordered separately.
- \* Natural silver-anodized, black in standard and various RAL colors available with antimicrobial powder coating.
- \* The heavy base provides stability.
- \* Packed unassembled in a sturdy box.



## COLOURS IN STOCK

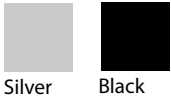

Silver Black

## COLOUR OPTIONS



## CORNER TYPES

### Snap Frame Corner

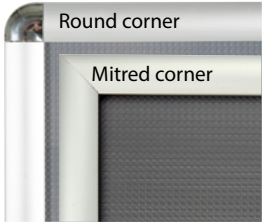

### Opti Frame Corner

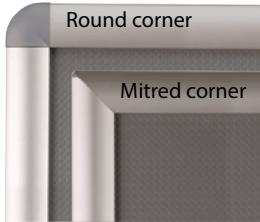

## SUITABLE FOR

Menuboards can be used for INDOOR applications, for signage needs in many locations like shopping centers, markets, groceries, hotels, offices airports, shops and stores, hospitals, schools, apartments and many more.

## WATCH VIDEO



Watch video at our website [www.mtdisplays.com](http://www.mtdisplays.com)

## FEATURES

### Opti Frame



### Snap Frame



## EXPLODED VIEW



## TECHNICAL DRAWING

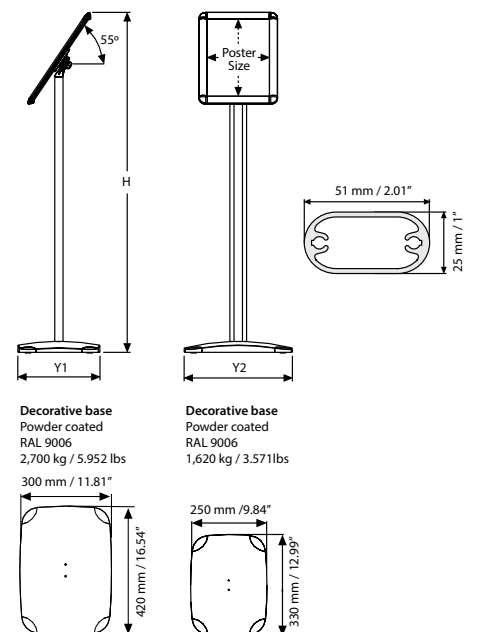

T: +90 850 433 67 85 / [info@mtdisplays.com](mailto:info@mtdisplays.com) / [www.mtdisplays.com](http://www.mtdisplays.com)

# ARTICLES

MITRED ARTICLE	ROUND ARTICLE	EXTERNAL (x-y)	POSTER	COPY	Y1	Y2	HEIGHT	DESCRIPTION	WEIGHT	PACKING SIZE
									WITH PACKING	*W X H X D
UDMB1N05A4	UDMB1N00A4	240 X 327 mm	210 X 297 mm	192 X 279 mm	250 mm	330 mm	1000 mm	A4 portrait / Silver	3,400 kg	290 X 980 X 65 mm
					250 mm	330 mm	964 mm	A4 landscape / Silver		
UDMB1B05A4	UDMB1B00A4	240 X 327 mm	210 X 297 mm	192 X 279 mm	250 mm	330 mm	1000 mm	A4 portrait / Black	3,400 kg	290 X 980 X 65 mm
					250 mm	330 mm	964 mm	A4 landscape / Black		
UDMB1N05A3	UDMB1N00A3	327 X 450 mm	297 X 420 mm	279 X 402 mm	420 mm	300 mm	1200 mm	A3 portrait / Silver	5,850 kg	380 X 1150 X 65 mm
					420 mm	300 mm	1150 mm	A3 landscape / Silver		
UDMB1B05A3	UDMB1B00A3	327 X 450 mm	297 X 420 mm	279 X 402 mm	420 mm	300 mm	1200 mm	A3 portrait / Black	5,850 kg	380 X 1150 X 65 mm
					420 mm	300 mm	1150 mm	A3 landscape / Black		
UDMB1N05A2	UDMB1N00A2	451 X 625 mm	420 X 594 mm	401 X 575 mm	420 mm	300 mm	1272 mm	A2 portrait / Silver	8,100 kg	490 X 1110 X 55 mm
					420 mm	300 mm	1200 mm	A2 landscape / Silver		
UDMB1B05A2	UDMB1B00A2	450 X 624 mm	420 X 594 mm	402 X 576 mm	420 mm	300 mm	1272 mm	A2 portrait / Black	8,100 kg	490 X 1110 X 55 mm
					420 mm	300 mm	1200 mm	A2 landscape / Black		
UDMB1N0518	UDMB1N0018	9.68" X 12.18"	8.5" X 11"	7.79" X 10.29"	9.84"	12.99"	39.37"	8.5" x 11" portrait / Silver	8.135 lbs	11.42" X 35.63" X 2.56"
					9.84"	12.99"	37.95"	8.5" x 11" landscape / Silver		
UDMB1B0518	UDMB1B0018	9.68" X 12.18"	8.5" X 11"	7.79" X 10.29"	9.84"	12.99"	39.37"	8.5" x 11" portrait / Black	8.135 lbs	11.42" X 35.63" X 2.56"
					9.84"	12.99"	37.95"	8.5" x 11" landscape / Black		
UDMB1N0517	UDMB1N0017	12.18" X 18.18"	11" X 17"	10.29" X 16.29"	16.54"	11.81"	47.24"	11" x 17" portrait / Silver	12.897 lbs	14.96" X 45.28" X 2.56"
					16.54"	11.81"	45.28"	11" x 17" landscape / Silver		
UDMB1B0517	UDMB1B0017	12.18" X 18.18"	11" X 17"	10.29" X 16.29"	16.54"	11.81"	47.24"	11" x 17" portrait / Black	12.897 lbs	14.96" X 45.28" X 2.56"
					16.54"	11.81"	45.28"	11" x 17" landscape / Black		
UDMB1N0581	UDMB1N0081	19.18" X 25.18"	18" X 24"	17.29" X 23.29"	16.54"	11.81"		18" x 24" portrait / Silver		
					16.54"	11.81"		18" x 24" landscape / Silver		
UDMB1B0581	UDMB1B0081	19.18" X 25.18"	18" X 24"	17.29" X 23.29"	16.54"	11.81"		18" x 24" portrait / Black		
					16.54"	11.81"		18" x 24" landscape / Black		

## OPTIONAL ACCESSORIES



Adapter for A4 Brochure Holder (30 Pcs) / UYPMBH00A4  
Adapter for A5 Brochure Holder (45 Pcs) / UYPMBH00A5



A4 Brochure Holder (30 Pcs) UMSDMB00A4



A5 Brochure Holder (45 Pcs) UMSDMB00A5

## PHYSICAL DATA

### Material

25x51mm aluminium ellipse profile body, 25mm snap-open aluminium profile poster frame, PET anti-reflex poster cover, PS backing or ABS backing. Acrylic optional shelves.

### Poster Material & Thickness

0,10 – 0,20 mm for standard product. Max poster thickness 1,5 mm for mitred corner, 1 mm for round corner. Any non-standard poster thicknesses should be indicated with order.

### Surface Finish

Silver anodized or black colour, antimicrobial powder coating. Custom colors also available, call for custom color requests.

### Recycled Content

Up to 78% recycled content used.

### Warranty

All products are guaranteed for 3 years by MT Displays with below conditions:  
[Warranty Conditions](#)

### Installation Considerations

Menuboards are packed unassembled in a sturdy box with an easy-to-understand instruction sheet & fixing elements. One set includes a powder coated decorative heavy base, aluminium ellipse profile body and a snap-open or opti-poster frame with a sight angle that catches the eye level. Optional A5 or A4 acrylic brochure holder and adapter should be ordered separately. When the nut on the back of frame is loose, frame can be placed in either portrait or landscape position.

### Storage Conditions

Goods should be stored at 0° to 25°C in a dry place. Store in the original package.

### Design Considerations

Suitable for silk screen printing, max. letter height is 15 mm. Various design options. Suitable for silk screen printing, max. letter height is 15 mm. Suitable for A3 and A4 poster sizes in Landscape and Portrait positions with a sight angle that catches the eye level. The heavy elegant base provides stability.

### Cleaning and Disinfecting

Clean your displays, with damp microfiber clothes, rinsed with simply water or warm, soapy or gentle shampooed water. Avoid using vinegar, abrasive, acidic, alcohol-based or heavy cleaners or cleaners containing Ammonia. Only after cleaning the product, if needed, simply apply disinfectant or sanitizer that is in compliance with your local guidelines and regulations.

## PRINT TEMPLATES

### Decorative Menuboard - A4

Document Size: 220 x 307 mm (Includes Bleeds)  
Finished Size: A4 (210 x 297 mm) [Print](#)

### Decorative Menuboard - A3

Document Size: 307 x 430 mm (Includes Bleeds)  
Finished Size: A3 (297 x 420 mm) [Print](#)

### Decorative Menuboard - A2

Document Size: 430 x 604 mm (Includes Bleeds)  
Finished Size: A2 (420 x 594 mm)

### Decorative Menuboard - 8.5"x11"

Document Size: 8.89" x 11.4" (Includes Bleeds)  
Finished Size: 8.5" x 11" (279.4 x 431.8 mm)

### Decorative Menuboard - 11"x17"

Document Size: 11.4" x 17.4" (Includes Bleeds)  
Finished Size: 11" x 17" (279.4 x 431.8 mm)

### Decorative Menuboard - 18"x24"

Document Size: 18.4" x 24.4" (Includes Bleeds)  
Finished Size: 18" x 24" (457.2 x 609.6 mm)



# INSTALLATION INSTRUCTIONS

## Decorative Menubard, Snap Frame / 1007024

### Each product includes

- 1 x Frame
- 1 x Base
- 1 x Main body
- 1 x 4 allen key
- 2 x Bolt M6x50

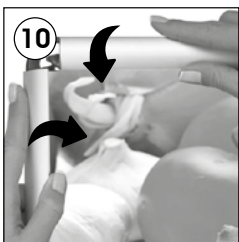
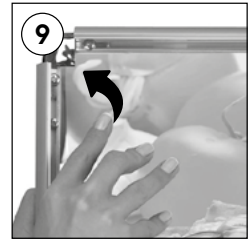
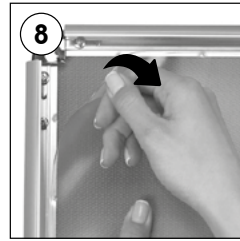
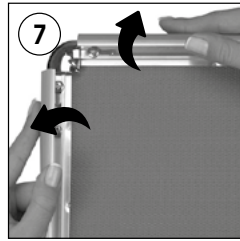
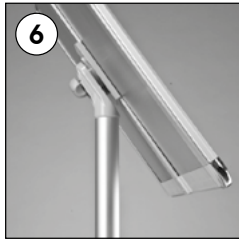
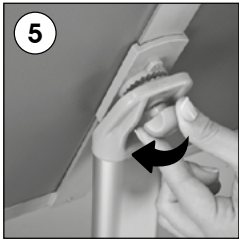
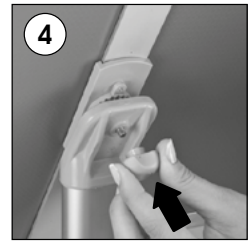
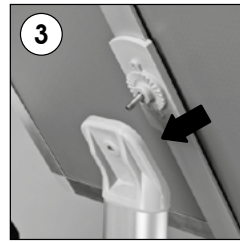
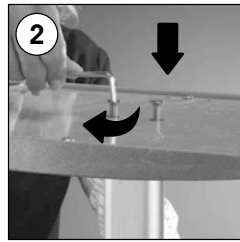
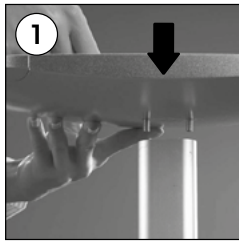

Portrait

Landscape



• Please inform the order number on the product or on the carton (e.g. 1/110001394-460) to the place that you have made the purchase if any problem with the product occurs.

• All rights reserved. All pictures, figures and writings are secured internationally by copy-right law. Infringements will be sued by civil and legal law.



# INSTALLATION INSTRUCTIONS

## Decorative Menubard, Opti Frame / 1011018H000

**Each product includes**

- 1 x Opti Frame
- 1 x Base
- 1 x Main body
- 1 x 4 allen key
- 2 x Bolt M6x50

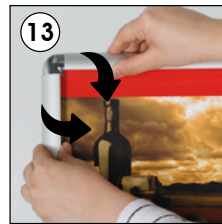
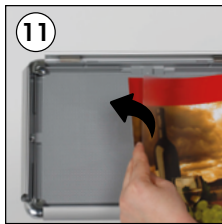
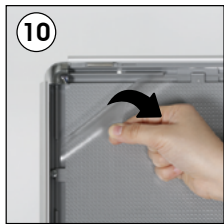
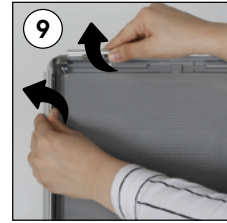
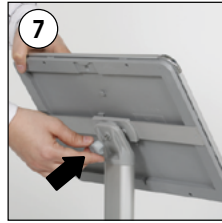
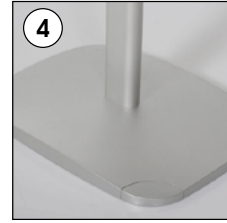
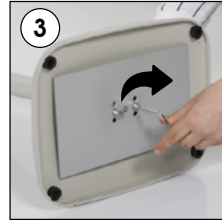
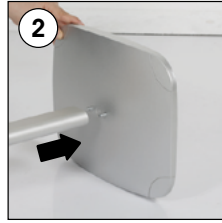

Portrait position    Landscape position

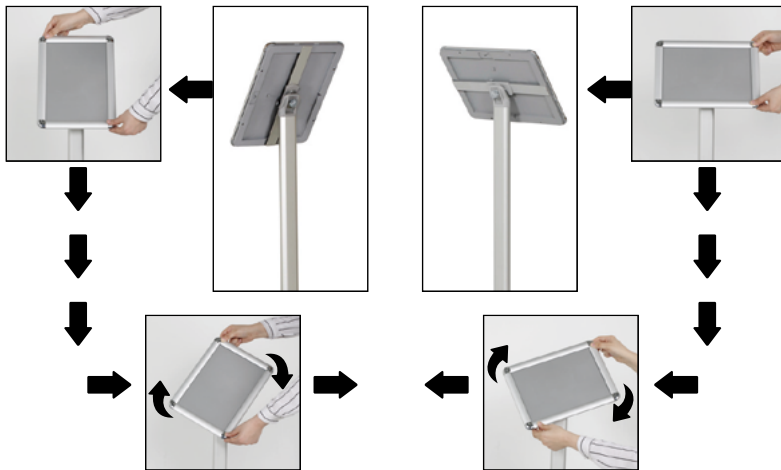

- Please inform the order number on the product or on the carton (e.g. 1/110001394-460) to the place that you have made the purchase if any problem with the product occurs.
- All rights reserved. All pictures, figures and writings are secured internationally by copy-right law. Infringements will be sued by civil and legal law.

This technical sheet's contents are all subject to update and modification at MT Displays' exclusive discretion. There is nothing official about this document. For final and legally binding information, please get in touch with the sales staff at MT Displays.



T: +90 850 433 67 85 / info@mtdisplays.com / www.mtdisplays.com