

ECO INFOBOARD



DOUBLE SIDED SIDEWALK SIGNS WITH EASY SLIDING DESIGN

25 mm Eco Info board is a new double-sided economy floor stand. The black PVC in middle of 2 posters prevent light transmission. Easy to change poster by simply sliding in through the channels of the stand. Eco Info board has different models that can go up to 2 or 3 tier and display max. 6 posters at once. It is suitable for public spaces & the square base provides stability.

KEY SELECTION ATTRIBUTES

- Double-sided Info Boards with sliding channel design for easy poster changing by simply sliding posters in channels from the top.
- Suitable for INDOOR public spaces
- 2 or 3 tier options are available for displaying multiple posters at a time
- One set includes frames for displaying posters on double sides, end caps, allen keys and connectors for fixing, anodised aluminium main body profiles and heavy steel base for stability.
- The separator in the middle of 2 posters prevent light transmission.
- Natural silver-anodized, black in standard and various RAL colors available with antimicrobial powder coating.
- 1 Tier and 2 Tier are packed unassembled in a single box. 500 x 1700 mm version is packed in 2 boxes.

It comes with an easy-to-understand instruction sheet and mounting hardware. Additionally, it is delivered with a poster protection set that includes anti-glare PET covers and a black backing.



Black, 1 Tier



Silver, 2 Tier



Black, 500 X 1700 mm



COLOURS IN STOCK

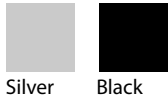

Silver Black

COLOUR OPTIONS

White - RAL 9003

Red - RAL 3020

Blue - RAL 5002

Green - RAL 6029

Yellow - RAL 1021

SUITABLE FOR

Eco Infoboards can be used for INDOOR applications, for signage needs in many public areas like shopping centers, markets, groceries, hotels, offices airports, shops and stores, hospitals, schools, apartments, restaurants, halls, meeting rooms, gas stations and many more.

WATCH VIDEO



Watch video at our website
www.mtdisplays.com

FEATURES



EXPLODED VIEW

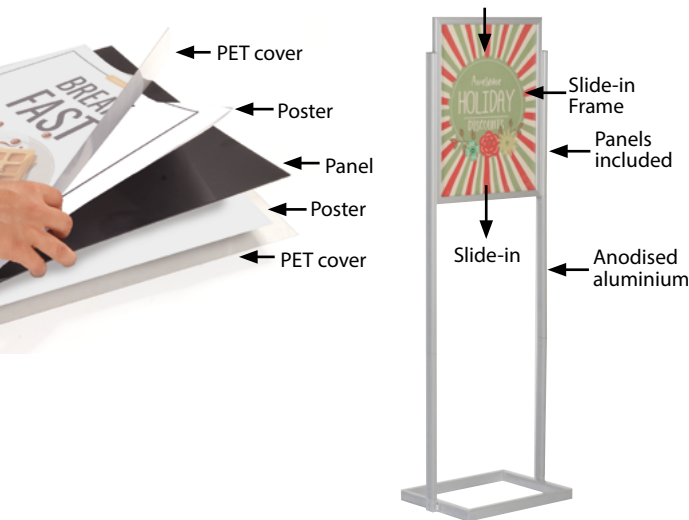

TECHNICAL DRAWING

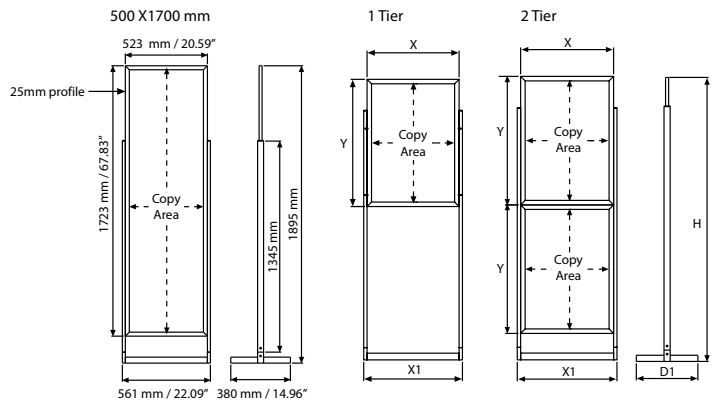

ARTICLES

1 TIER										WEIGHT	PACKING SIZE
SILVER	BLACK	POSTER	COPY	X	X1	Y	D1	H		WITH PACKING	*W X H X D
UIBS20N1A1	UIBS20C1A1	594 X 841 mm	566 X 813 mm	617 mm	656 mm	864 mm	380 mm	1595 mm			
UIBS20N1B2	UIBS20C1B2	500 X 700 mm	472 X 672 mm	523 mm	562 mm	723 mm	380 mm	1595 mm			
UIBS20N118	UIBS20B118	18" X 24"	16.93" X 22.91"	18.94"	20.47"	24.92"	14.96"	62.80"	14.175 lbs	23.43" X 69.29" X 3.35"	
UIBS20N122	UIBS20B122	22" X 28"	20.91" X 26.93"	22.91"	24.45"	28.94"	14.96"	62.80"	16.203 lbs	27.36" X 65.75" X 3.35"	
UIBS20N124	UIBS20B124	24" X 36"	22.91" X 34.92"	24.92"	26.46"	36.93"	14.96"	62.80"	16.975 lbs	29.53" X 69.29" X 3.35"	

2 TIER										WEIGHT	PACKING SIZE
SILVER	BLACK	POSTER	COPY	X	X1	Y	D1	H		WITH PACKING	*W X H X D
UIBS20N2A1	UIBS20C2A1	594 X 841 mm	566 X 813 mm	617 mm	656 mm	864 mm	450 mm	1820 mm			
UIBS20N2B2	UIBS20C2B2	500 X 700 mm	472 X 672 mm	523 mm	562 mm	723 mm	380 mm	1595 mm			
UIBS20N218	UIBS20B218	18" X 24"	16.93" X 22.91"	18.94"	20.47"	24.92"	17.72"	62.80"	18.210 lbs	23.43" X 73.43" X 3.35"	
UIBS20N222	UIBS20B222	22" X 28"	20.91" X 26.93"	22.91"	24.45"	28.94"	17.72"	62.80"	21.715 lbs	27.36" X 65.75" X 3.35"	
UIBS20N224	UIBS20B224	24" X 36"	22.91" X 34.92"	24.92"	26.46"	36.93"	17.72"	62.80"	23.589 lbs	27.17" X 76.57" X 3.35"	

500 x 1700 mm				WEIGHT	PACKING SIZE
ARTICLE	POSTER	COPY	MODEL	WITH PACKING	*W X H X D
UIBS20N151	500 X 1700 mm	472 X 1672 mm	Silver anodised		
UIBS20C151	500 X 1700 mm	472 X 1672 mm	Black powder coated		
UIBS20N129	22" X 69"	20.91" X 67.91"	Silver anodised	24.691 lbs	26.38" X 80.12" X 3.35"
UIBS20C129	22" X 69"	20.91" X 67.91"	Black powder coated	24.691 lbs	26.38" X 80.12" X 3.35"



T: +90 850 433 67 85 / info@mtdisplays.com / www.mtdisplays.com

PHYSICAL DATA

Material

Aluminium profile poster frame and main body profiles, steel base, PET anti-reflex poster cover and PVC backing.

Poster Material & Thickness

0,10 - 2,00 mm for standard product. Max poster thickness is 1,50 mm without separator. When used without separator and 2 PET poster protection, max poster thickness is 6,00 mm. Any non-standard poster thickness should be indicated with the order.

Surface Finish

Natural silver-anodized, or black in standard and various RAL colors available with antimicrobial powder coating. Call for custom color requests.

Recycled Content

Up to %70 recycled content used.

Warranty

All products are guaranteed for 3 years by MT Displays with below conditions:
[Warranty Conditions](#)

Storage Conditions

Goods should be stored at 0° to 25°C in a dry place. Store in the original package.

Installation Considerations

The product is packed unassembled with an easy-to-understand instruction sheet & fixing elements hardware. Delivered with poster protective set that includes 2 clear + 1 black sheet

Design Considerations

Double-sided Info Boards with sliding channel design for easy poster changing by simply sliding posters in channels from the top. Suitable for indoor public spaces with 2 or 3 tier options are available for displaying multiple posters at a time. The black PVC in the middle of 2 posters prevent light transmission. Heavy steel base provides stability.

Cleaning and Disinfecting

Clean your displays, with damp microfiber clothes, rinsed with simply water or warm, soapy or gentle shampooed water. Avoid using vinegar, abrasive, acidic, alcohol-based or heavy cleaners or cleaners containing Ammonia. Only after cleaning the product, if needed, simply apply disinfectant or sanitizer that is in compliance with your local guidelines and regulations.

PRINT TEMPLATES

Eco Infoboard 1 Tier & 2 Tier - A1

Document Size: 604 x 851 mm (Includes Bleeds)
Finished Size: A1 (594 x 841 mm) [Print](#)

Eco Infoboard 1 Tier & 2 Tier - B2

Document Size: 510 x 710 mm (Includes Bleeds)
Finished Size: B2 (500 x 700 mm) [Print](#)

Eco Infoboard - 500x1700 mm

Document Size: 510 x 1710 mm (Includes Bleeds)
Finished Size: 500x1700 mm [Print](#)

Eco Infoboard - 18"x24"

Document Size: 18.4" x 24.4" (Includes Bleeds)
Finished Size: 18"x24" (457.2x609.6 mm)

Eco Infoboard - 22"x28"

Document Size: 22.4" x 28.4" (Includes Bleeds)
Finished Size: 22"x28" (558.8x711.1 mm)

Eco Infoboard - 24"x36"

Document Size: 24.4" x 36.4" (Includes Bleeds)
Finished Size: 24"x36" (609.6x914.4 mm)

Eco Infoboard - 22"x69"

Document Size: 22.4" x 69.4" (Includes Bleeds)
Finished Size: 22"x69" (558.8"x1752.6 mm)



INSTALLATION INSTRUCTIONS

Eco Infoboard 1Tier / 1013022H000

Each product includes mounting accessories

- 1 x Base
- 1 x Frame
- 2 x Main body profile
- 1 x Poster protective set (2 x PET, 1 x black sheet)
- 1 x 3 Allen key
- 4 x En cap Ø10

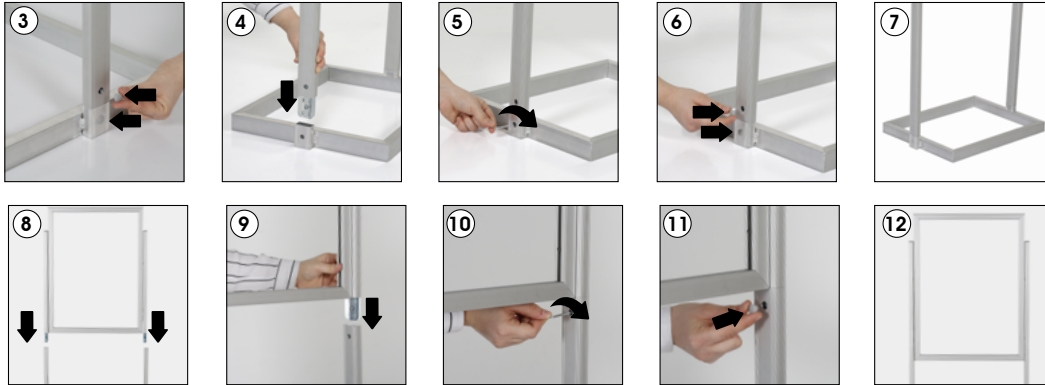
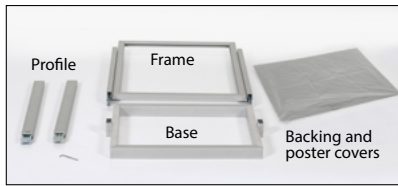

Backing and poster covers

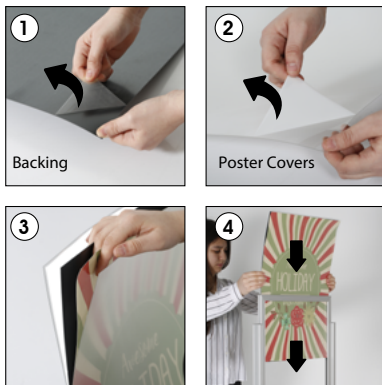
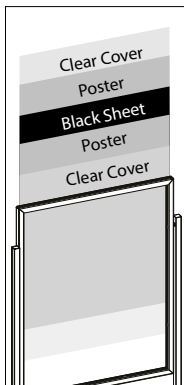

INSTALLATION INSTRUCTIONS

Eco Infoboard 2Tier / 1013021H000

Each product includes mounting accessories

- 1 x Base
- 1 x Top Frame
- 1 x Bottom Frame
- 2 x Poster protective set (4 x PET, 2 x black sheet)
- 1 x 3 Allen key
- 8 x En cap Ø10

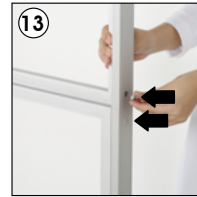
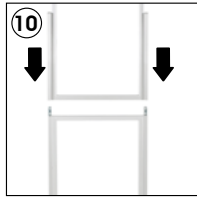
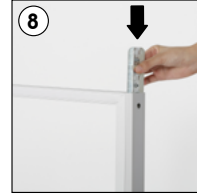
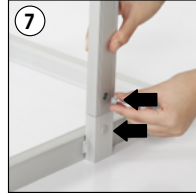
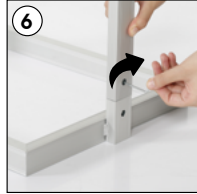
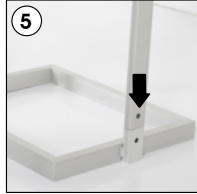
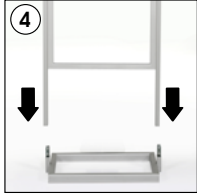
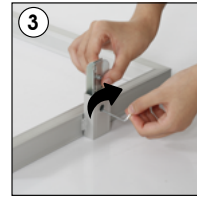
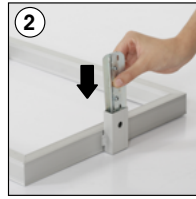
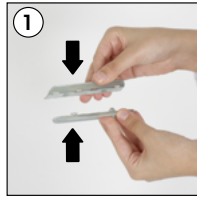
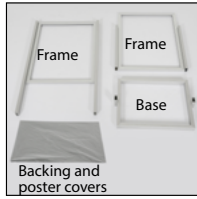

Backing and poster covers

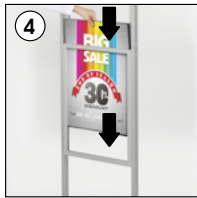
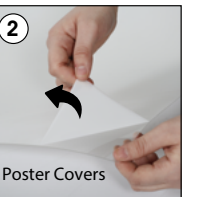
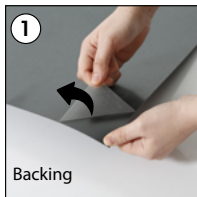
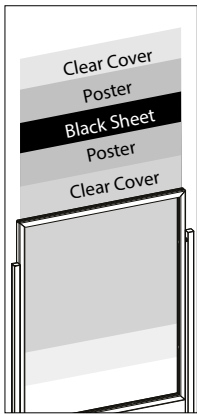

- Please inform the order number on the product or on the carton (e.g. 1/110001394-460) to the place that you have made the purchase if any problem with the product occurs.
- All rights reserved. All pictures, figures and writings are secured internationally by copy-right law. Infringements will be sued by civil and legal law.



INSTALLATION INSTRUCTIONS

Eco Infoboard 500x1700 mm / 1013020H000

Each product includes

- mounting accessories
- 1 x Base
- 1 x Top Frame
- 1 x Bottom Frame
- 1 x Poster protective set (2 x PET, 1 x black sheet)
- 8 x Connector
- 8 x Endcap
- 1 x 3 Allen key

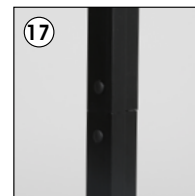
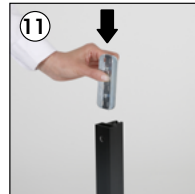
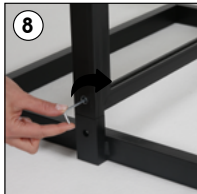
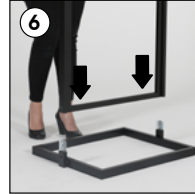
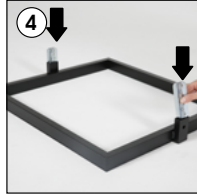
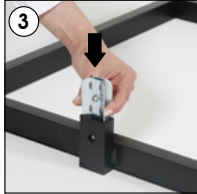
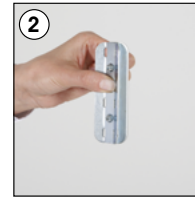
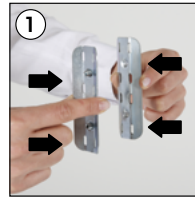
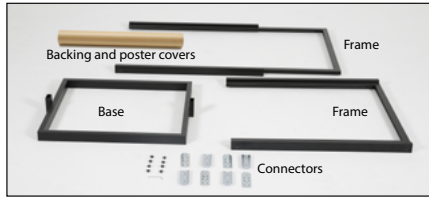

Backing and poster covers

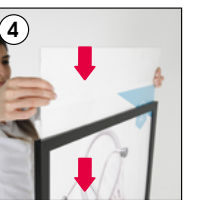
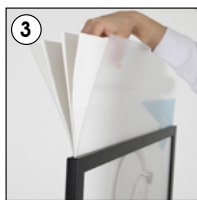
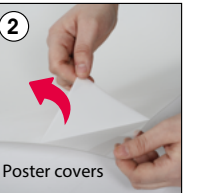
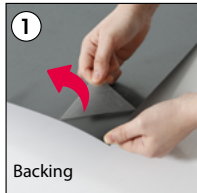
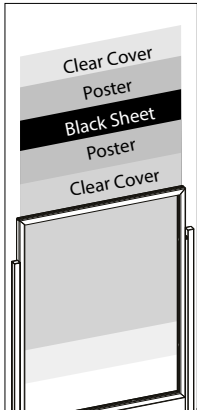

- Please inform the order number on the product or on the carton (e.g. 1/110001394-460) to the place that you have made the purchase if any problem with the product occurs.
- All rights reserved. All pictures, figures and writings are secured internationally by copy-right law. Infringements will be sued by civil and legal law.

This technical sheet's contents are all subject to update and modification at MT Displays' exclusive discretion. There is nothing official about this document. For final and legally binding information, please get in touch with the sales staff at MT Displays.



T: +90 850 433 67 85 / info@mtdisplays.com / www.mtdisplays.com