

ECO SWINGMASTER



COST-SAVING SIDEWALK SIGNS WITH FLEXIBLE SPRING DESIGN

Various sizes are available all with safe mitred corners. Its round corners do not have sharp edges. After the closure of the side profiles, the rubber seal inside the swingmaster in addition with over size PET makes the product waterproof. The easy-to-open snap frame includes an anti-reflex cover suitable for external use when equipped with a water wick. Product is double sided. The steel springs provide the flexibility to ensure stability.

KEY SELECTION ATTRIBUTES

- * Double-sided Pavement Sign with steel spring design for flexibility and stability.
- * Suitable for various poster sizes, available with round mitred corners for safety.
- * Wind Resistant: Suitable for windy outdoor conditions.
- * Weatherproof IP56: Suitable for rainy conditions with over size anti-reflex PET and a rubber seal around the frame for protecting the poster within. Anti-reflex cover is suitable for external use when equipped with a water wick.

- * One set includes a double sided snap open swing master frame, 2 anti-reflex poster covers, 1 PP backing, steel base profile, 2 bolts, 2 washers and 2 pipes for installation.
- * Optional header accessories available.
- * Heavy long feet on the base provide stability.
- * Natural silver-anodized, black in standard and various RAL colors available with antimicrobial powder coating.
- * Packed unassembled with an easy mounting instruction sheet & fixing set.



COLOURS IN STOCK



Silver

SUITABLE FOR

Swingmaster can be used for INDOOR and OUTDOOR applications, for signage needs in many locations like shopping centers, markets, groceries, hotels, offices airports, shops and stores, hospitals, schools, apartments and many more.

WATCH VIDEO



Watch video at our website www.mtdisplays.com

FEATURES



EXPLODED VIEW



TECHNICAL DRAWING

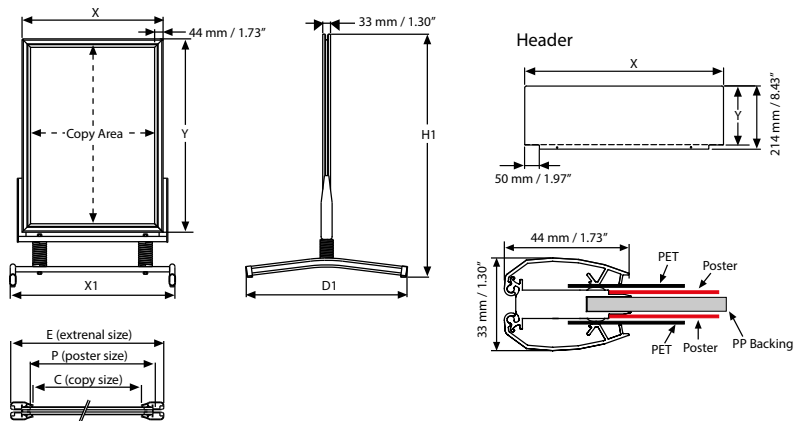

ARTICLES

ARTICLE	EXTERNAL (x-y)	POSTER	COPY	H1
UESM000A2	479 X 671 mm	420 X 594 mm	408 X 582 mm	905 mm
UESM000A1	671 X 918 mm	594 X 841 mm	582 X 829 mm	1170 mm
UESM000A0	918 X 1266 mm	841 X 1189 mm	829 X 1177 mm	1540 mm
UESM000B2	577 X 777 mm	500 X 700 mm	488 X 688 mm	1015 mm
UESM000B1	777 X 1077 mm	700 X 1000 mm	688 X 988 mm	1340 mm
UESM000B0	1077 X 1477 mm	1000 X 1400 mm	988 X 1388 mm	1765 mm
UESM000N22	25.03" X 31.03"	22" X 28"	21.53" X 27.53"	40.94"
UESM000N23	23.03" X 33.03"	20" X 30"	19.53" X 29.53"	42.32"
UESM000N24	27.03" X 39.03"	24" X 36"	23.53" X 35.53"	49.02"
UESM000N34	33.03" X 43.03"	30" X 40"	29.53" X 39.53"	53.35"
UESM000N46	43.03" X 63.03"	40" X 60"	39.53" X 59.53"	74.61"

WEIGHT	PACKING SIZE	LEG		
WITH PACKING	*W X H X D	X1	D1	SPRINGS
10,000 kg	620 X 920 X 105 mm	610 mm	850 mm	2
15,750 kg	810 X 1170 X 105 mm	785 mm	1050 mm	2
21,250 kg	1050 X 1510 X 105 mm	1030 mm	1400 mm	2
11,900 kg	710 X 950 X 105 mm	690 mm	905 mm	2
18,250 kg	910 X 1250 X 105 mm	890 mm	1240 mm	2
25,200 kg	1210 X 1650 X 105 mm	1195 mm	1600 mm	2
27.116 lbs	29.72" X 36.81" X 4.13"	25.28"	35.43"	2
27.116 lbs	27.95" X 38.98" X 4.13"	25.28"	35.43"	2
34.171 lbs	27.95" X 41.34" X 4.13"	28.66"	41.34"	2
41.887 lbs	965" X 50.79" X 4.13"	35.28"	48.82"	2
57.320 lbs	48.03" X 71.06" X 4.13"	45.28"	62.99"	2

HEADER	WEIGHT	
ARTICLE	PRINTING AREA (x-y)	WITH PACKING
UYFT0050A2	479 X 200 mm	1,885 kg
UYFT0050A1	671 X 200 mm	2,640 kg
UYFT0050A0	918 X 200 mm	3,615 kg
UYFT0050B2	577 X 200 mm	2,270 kg
UYFT0050B1	777 X 200 mm	3,060 kg
UYFT0050B0	1077 X 200 mm	4,240 kg
UYFT005022	25" X 7.87"	0.551 lbs
UYFT005023	23.03" X 7.87"	0.507 lbs
UYFT005024	27.05" X 7.87"	0.595 lbs
UYFT005034	33.03" X 7.87"	0.738 lbs
UYFT005046	43.03" X 7.87"	0.992 lbs

OPTIONAL ACCESSORIES



Eco Swingmaster & Eco Waterbase Wind Sign header (3 PVC Foam).

PHYSICAL DATA

Material

45mm aluminium profile snap open swing master frame, PET anti-reflex poster cover, PP backing, steel profile base, optional PVC Foam header.

Poster Material & Thickness

0,10 – 0,20 mm for standard product. Max poster thickness is 2 mm. Any non-standard poster thicknesses should be indicated with order.

Surface Finish

Natural silver-anodized, or black in standard and various RAL colors available with antimicrobial powder coating. Call for custom color requests.

Recycled Content

Up to ??? recycled content used.

Warranty

All products are guaranteed for 3 years by MT Displays with below conditions:

[Warranty Conditions](#)

Installation Considerations

Swingmasters are packed unassembled with an easy mounting instruction sheet & fixing set. One set includes a double sided snap open swing master frame, 2 anti-reflex poster covers, 1 PP backing, steel base profile, 2 bolts, 2 washers and 2 pipes for installation. Optional header accessories available.

Storage Conditions

Goods should be stored at 0° to 25°C in a dry place. Store in the original package.

Design Considerations

Double-sided Pavement Sign with steel spring design for flexibility and stability. Suitable for various poster sizes, available with round mitred corners for raising safety level on the pavement. Suitable for windy outdoor conditions. Suitable for rainy conditions with over size anti-reflex PET and a rubber seal around the frame for protecting the poster within. Anti-reflex cover is suitable for

external use when equipped with a water wick. Heavy long feet on the base provide stability.

Cleaning and Disinfecting

Clean your displays, with damp microfiber clothes, rinsed with simply water or warm, soapy or gentle shampooed water. Avoid using vinegar, abrasive, acidic, alcohol-based or heavy cleaners or cleaners containing Ammonia. Only after cleaning the product, if needed, simply apply disinfectant or sanitizer that is in compliance with your local guidelines and regulations.

Patent

PCT/EP2018/060515



T: +90 850 433 67 85 / info@mtdisplays.com / www.mtdisplays.com

PRINT TEMPLATES

Eco Swingmaster - A2

Document Size: 430 x 604 mm (Includes Bleeds)
 Finished Size: A2 (420 x 594 mm) [Print](#)

Eco Swingmaster - A1

Document Size: 604 x 851 mm (Includes Bleeds)
 Finished Size: A1 (594 x 841 mm) [Print](#)

Eco Swingmaster - A0

Document Size: 851 x 1199 (Includes Bleeds)
 Finished Size: A0 (841 x 1189 mm) [Print](#)

Eco Swingmaster - B2

Document Size: 510 x 710 (Includes Bleeds)
 Finished Size: B2 (500 x 700 mm) [Print](#)

Eco Swingmaster - B1

Document Size: 710 x 1010 (Includes Bleeds)
 Finished Size: B1 (700 x 1000 mm) [Print](#)

Eco Swingmaster - B0

Document Size: 1010 x 1410 (Includes Bleeds)
 Finished Size: B0 (1000 x 1400 mm) [Print](#)

Eco Swingmaster - 20" x 30"

Document Size: 20.4" x 30.4" (Includes Bleeds)
 Finished Size: 20" x 30" (508 x 762 mm) [Print](#)

Eco Swingmaster - 22" x 28"

Document Size: 22.4" x 28.4" (Includes Bleeds)
 Finished Size: 22" x 28" (558.8 x 711.2 mm) [Print](#)

Eco Swingmaster - 24" x 36"

Document Size: 24.4" x 36.4" (Includes Bleeds)
 Finished Size: 24" x 36" (609.6 x 914.4 mm) [Print](#)

Eco Swingmaster - 30" x 40"

Document Size: 30.4" x 40.4" (Includes Bleeds)
 Finished Size: 30" x 40" (762 x 1016 mm) [Print](#)

Eco Swingmaster - 40" x 60"

Document Size: 40.4 x 60.4 (Includes Bleeds)
 Finished Size: 40" x 60" (1016 x 1524 mm) [Print](#)

INSTALLATION INSTRUCTIONS

Eco Swingmaster / 1010536H000

Each product package includes

- 1 x Eco Swing Master Frame
- 1 x Base profile
- 2 x PET cover
- 2 x Bolt M16x65 mm
- 2 x Washer serrated Ø16
- 2 x Pipe Ø20x2 mm

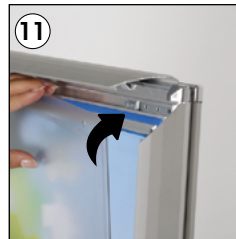
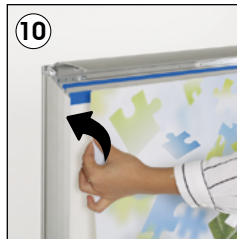
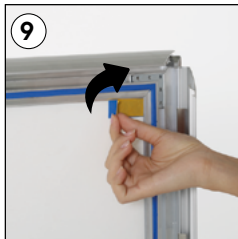
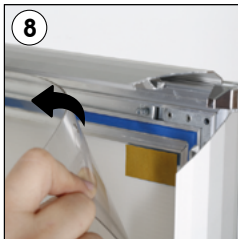
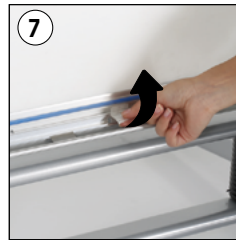
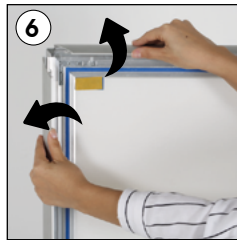
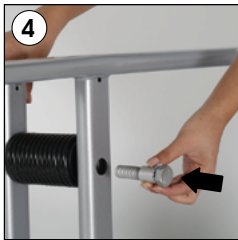
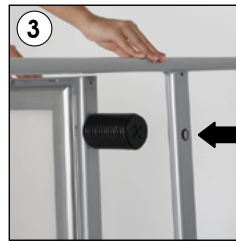
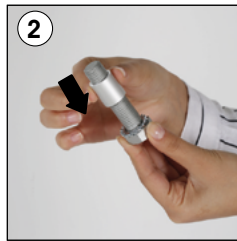
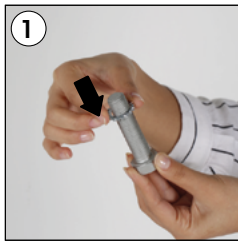

• Please inform the order number on the product or on the carton (e.g. 1/110001394-460) to the place that you have made the purchase if any problem with the product occurs.

• All rights reserved. All pictures, figures and writings are secured internationally by copy-right law. Infringements will be sued by civil and legal law.

This technical sheet's contents are all subject to update and modification at MT Displays' exclusive discretion. There is nothing official about this document. For final and legally binding information, please get in touch with the sales staff at MT Displays.



T: +90 850 433 67 85 / info@mtdisplays.com / www.mtdisplays.com