

FANCY FRAME



HIDDEN DESIGN FOR MORE DECORATIVE AND PROFESSIONAL PRESENTATION OF YOUR ADS

Fancy Frame, with a snap open design, is a simple to use framing system that makes changing graphics easy. The Fancy Frames are in different sizes and fits in decorative use of picture frames serving the needs of advertisers and decorators.

These clip frames differ from conventional snap frame designs due to the decorative form. This decorative design catches viewer's attention on the displayed advertisements. Having a more stylish design than traditional models, these picture frames will capture the eyes within any commercial environment.

Fancy Frame has mounting holes that are located underneath the molding. This hidden design makes this decorative frame look more professional, and enables it to mesh with any environment. This snap poster frames is hence perfect for those looking for long-term displaying, with the ability for easy and quick update of the art. Poster update only takes less than a minute of a person. Just snap open all sides and place the poster with the protective non glare cover over it, then close the frame. Protective non glare cover protects your poster from getting dirt and dust as well as prevents glaring.

KEY SELECTION ATTRIBUTES

- Ideal for various poster sizes.
- Natural silver-anodized and various RAL colors available with antimicrobial powder coating.
- Optional V-Hangers for easy mounting.
- Mitred corner alternatives.
- Anti-glare poster cover sheet.



Beige



Silver



Black



COLOURS IN STOCK



COLOUR OPTIONS

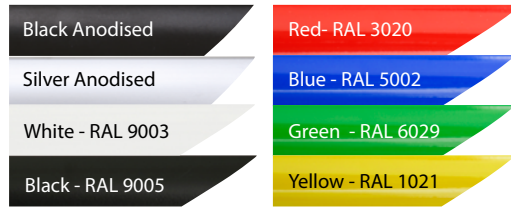

CORNER TYPES



SUITABLE FOR

Fancy Frame can be used for INDOOR applications, for signage needs in many locations like shopping centers, markets, groceries, hotels, offices airports, shops and stores, hospitals, schools, apartments, retail stores, exhibition centers, libraries, museums, telecom companies, travel agencies, restaurants, hotel receptions, banks and waiting areas and many more.

WATCH VIDEO



Watch video at our website www.mtdisplays.com

FEATURES



EXPLODED VIEW

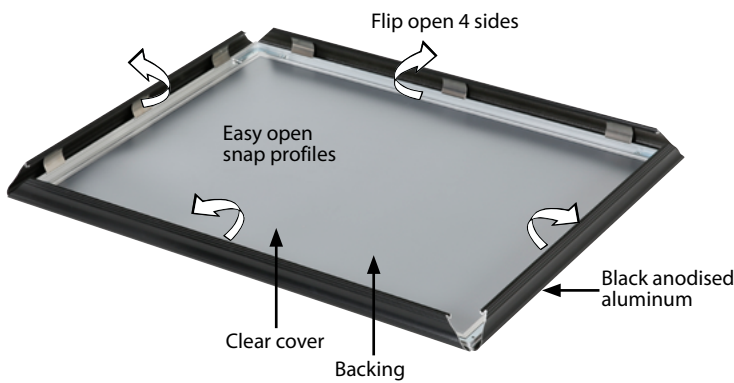

TECHNICAL DRAWING

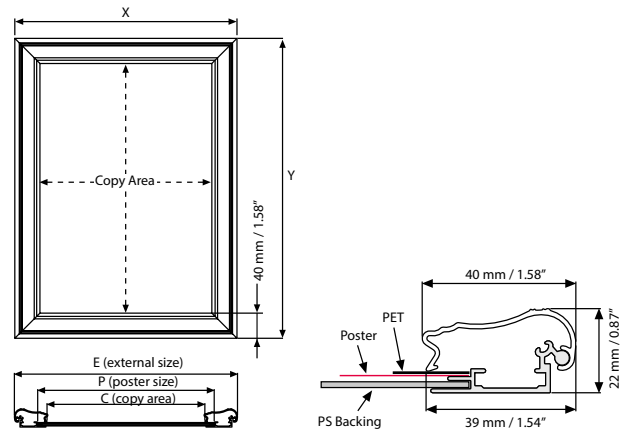

ARTICLES

SILVER	BLACK	BEIGE	EXTERNAL (x-y)	POSTER	COPY	WEIGHT	PACKING SIZE
						WITH PACKING	*W X H X D
UCF405N0A4	UCF405B0A4	UCF405COA4	265 X 352 mm	210 X 297 mm	188 X 275 mm	0,860 kg	260 X 350 X 31 mm
UCF405N0A3	UCF405B0A3	UCF405COA3	352 X 475 mm	297 X 420 mm	275 X 398 mm	1,240 kg	360 X 460 X 31 mm
UCF405N0A2	UCF405B0A2	UCF405COA2	475 X 649 mm	420 X 594 mm	398 X 572 mm	1,900 kg	460 X 670 X 31 mm
UCF405N0A1	UCF405B0A1	UCF405COA1	649 X 896 mm	594 X 841 mm	572 X 819 mm	3,155 kg	660 X 910 X 31 mm
UCF405N0A0	UCF405B0A0	UCF405COA0	896 X 1244 mm	841 X 1189 mm	819 X 1167 mm	5,600 kg	910 X 1270 X 31 mm
UCF405N0B2	UCF405B0B2	UCF405COB2	555 X 755 mm	500 X 700 mm	478 X 678 mm	2,340 kg	560 X 760 X 31 mm
UCF405N0B1	UCF405B0B1	UCF405COB1	755 X 1055 mm	700 X 1000 mm	678 X 978 mm	4,120 kg	760 X 1060 X 31 mm
UCF405N0B0	UCF405B0B0	UCF405COB0	1055 X 1455 mm	1000 X 1400 mm	978 X 1378 mm	7,880 kg	1070 X 1480 X 31 mm
UCF405N023	UCF405B023	UCF405CO23	563 X 817 mm	508 X 762 mm	486 X 740 mm	2,465 kg	570 X 830 X 31 mm
UCF405N034	UCF405B034	UCF405CO34	817 X 1071 mm	762 X 1016 mm	740 X 994 mm	4,540 kg	820 X 1080 X 31 mm
UCF405N046	UCF405B046	UCF405CO46	1071 X 1579 mm	1016 X 1524 mm	994 X 1502 mm	8,340 kg	1080 X 1590 X 31 mm
UCF405N022	UCF405B022	UCF405CO22	26.18" X 38.15"	22" X 28"	21.14" X 27.13"	5.291 lbs	24.41" X 30.71" X 1.22"
UCF405N024	UCF405B024	UCF405CO24	24.17" X 30.16"	24" X 36"	23.15" X 35.12"	5.732 lbs	26.77" X 38.58" X 1.22"

OPTIONAL ACCESSORIES



V Hanger / UYAA011010



PHYSICAL DATA

Material

40 mm aluminum profiles.
PET poster cover, PS backing or ABS backing.

Poster Material & Thickness

0,10 – 0,20 mm for standard product. Max poster thickness is 5 mm. Any non-standard poster thicknesses should be indicated with order.

Surface Finish

Silver anodized or black colour, antimicrobial powder coating. Custom colors also available, call for custom color requests.

Recycled Content

Up to 78% recycled content used.

Warranty

All products are guaranteed for 3 years by MT Displays with below conditions:
[Warranty Conditions](#)

Installation Considerations

Each frame includes wall mounting accessories (4 screws & 4 plugs). Each frame is packed individually in a cardboard box. Optional hangers help easy mounting.

Design Considerations

Suitable for silk screen printing, max. letter height is 16 mm.

Cleaning and Disinfecting

Clean your displays, with damp microfiber clothes, rinsed with simply water or warm, soapy or gentle shampooed water. Avoid using vinegar, abrasive, acidic, alcohol-based or heavy cleaners or cleaners containing Ammonia. Only after cleaning the product, if needed, simply apply disinfectant or sanitizer that is in compliance with your local guidelines and regulations.

PRINT TEMPLATES

Fancy Frame - A4

Document Size: 220 x 307 mm (Includes Bleeds)
Finished Size: A4 (210 x 297 mm) [Print](#)

Fancy Frame - A3

Document Size: 307 x 430 mm (Includes Bleeds)
Finished Size: A3 (297 x 420 mm) [Print](#)

Fancy Frame - A2

Document Size: 430 x 604 mm (Includes Bleeds)
Finished Size: A2 (420 x 594 mm) [Print](#)

Fancy Frame - A1

Document Size: 604 x 851 mm (Includes Bleeds)
Finished Size: A1 (594 x 841 mm) [Print](#)

Fancy Frame - A0

Document Size: 851 x 1199 mm (Includes Bleeds)
Finished Size: A0 (841 x 1189 mm) [Print](#)

Fancy Frame - B2

Document Size: 510 x 710 mm (Includes Bleeds)
Finished Size: B2 (500 x 700 mm) [Print](#)

Fancy Frame - B1

Document Size: 710 x 1010 mm (Includes Bleeds)
Finished Size: B1 (700 x 1000 mm) [Print](#)

Fancy Frame - B0

Document Size: 1010 x 1410 mm (Includes Bleeds)
Finished Size: B0 (1000x 1400 mm) [Print](#)

Fancy Frame 1.58" - 20"x30"

Document Size: 20.4" x 30.4" (Includes Bleeds)
Finished Size: 20"x30" (508x762 mm) [Print](#)

Fancy Frame 1.58" - 22"x28"

Document Size: 22.4" x 28.4" (Includes Bleeds)
Finished Size: 22"x28" (508x762 mm)

Fancy Frame 1.58" - 24"x36"

Document Size: 24.4" x 36.4" (Includes Bleeds)
Finished Size: 24"x36" (508x762 mm)

Fancy Frame 1.58" - 30"x40"

Document Size: 30.4" x 40.4" (Includes Bleeds)
Finished Size: 30"x40" (762x1016 mm) [Print](#)

Fancy Frame 1.81" - 40"x60"

Document Size: 40.4" x 60.4" (Includes Bleeds)
Finished Size: 40"x60" (1016x1524 mm) [Print](#)



INSTALLATION INSTRUCTIONS

Fancy Frame / 1005988

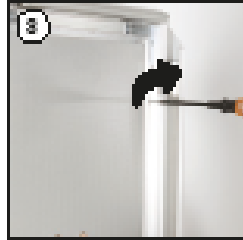
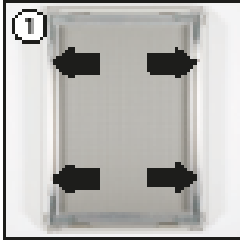
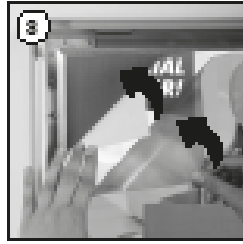
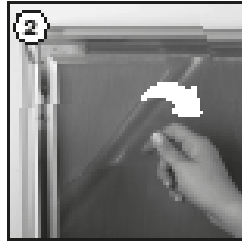
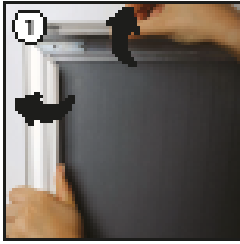

Each frame include wall mounting accessories (4 screws @ 4 inches)

Scrape & anchor mounting

Fixing screws corner

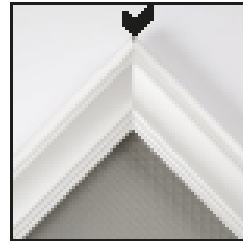
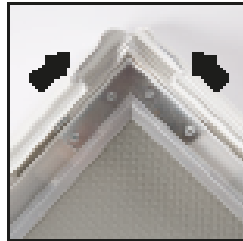
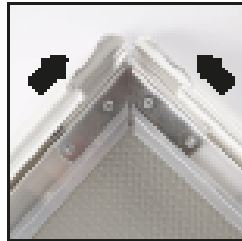
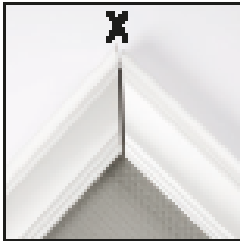

1. If your frame corner are slightly uneven, they is on your side. Follow these steps with care as the corners are sharp.

2. Loosen the metal brackets on the back of your frame near the gap and loosen the screws. Push the two sides of the frame together and tighten the screws.

3. Your frame corner should be perfectly aligned.

- Please follow the instructions from the product as on the carton (eg. If 10000 394-462) to replace that you have used the product it compatible with the product occur.
- All rights reserved. All pictures, signs and writings are protected internationally by copyright law. All rights reserved will be subject by civil and legal law.



This technical sheet's contents are all subject to update and modification at MT Displays' exclusive discretion. There is nothing official about this document. For final and legally binding information, please get in touch with the sales staff at MT Displays.



T: +90 850 433 67 85 / info@mtdisplays.com / www.mtdisplays.com