

## FAST NOTE



## PERFECT FOR HANGING YOUR PAPERS, NOTES WITHOUT MAGNETS OR PINS

Fast Note is a product which enables you to hang your papers, notes, pictures or photos without magnets or pins. It has a slim and compact design. Thanks to the cylinders in the profile you can easily keep the paper inside. Fast Note is suitable for restaurants, agencies, studios, hospitals, hotels, conference rooms, houses and offices. The standard color is anodized silver. Other colors and sizes are available upon request. You can either assemble the product on the wall by fixing the holes on the profile with screws and wall-plugs or apply the double-sided tape at any given point.

## KEY SELECTION ATTRIBUTES

- \* Slim & compact design poster holder.
- \* Enables to hang/change the posters/papers without magnets or pins.
- \* Cylinders inside the profile make it easy to keep posters in place.
- \* Easy fixing on wall by "peel & stick" principle or screwing.
- \* Silver anodised aluminium in standard.
- \* Other colors and sizes are available upon request.
- \* Ideal for various sizes of posters.
- \* Suitable for 0,1 mm - 0,8 mm poster/paper thicknesses.
- \* One set includes main profile with cylinders, moving end caps with discrete holes for fixing and double sided tape.
- \* Suitable for silk screen printing.

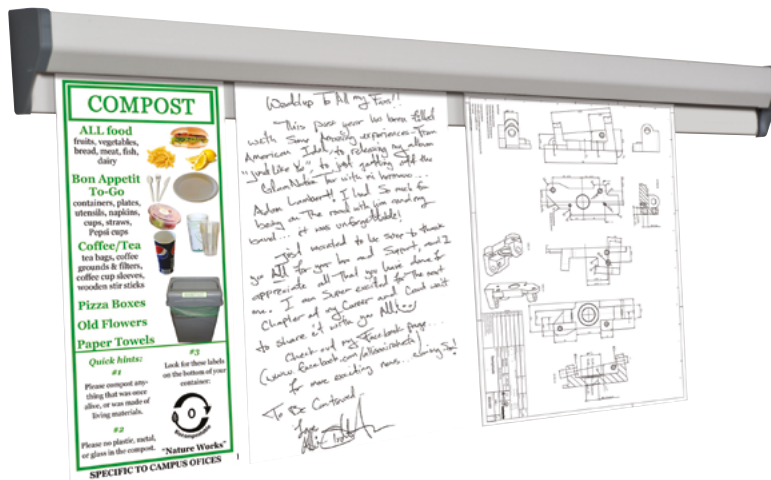

## COLOURS IN STOCK



Silver

## SUITABLE FOR

Fast Notes can be used for INDOOR applications, for signage needs in many locations like shopping centers, markets, groceries, hotels, offices airports, shops and stores, hospitals, schools, apartments and many more.

## WATCH VIDEO



Watch video at our website  
www.mtdisplays.com

## FEATURES



## EXPLODED VIEW

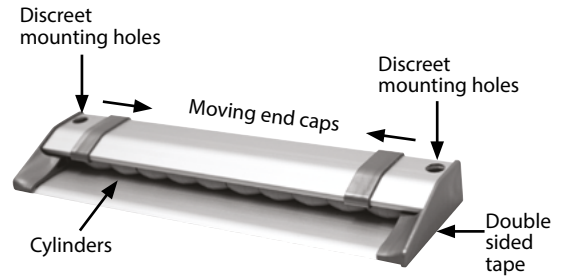

## TECHNICAL DRAWING

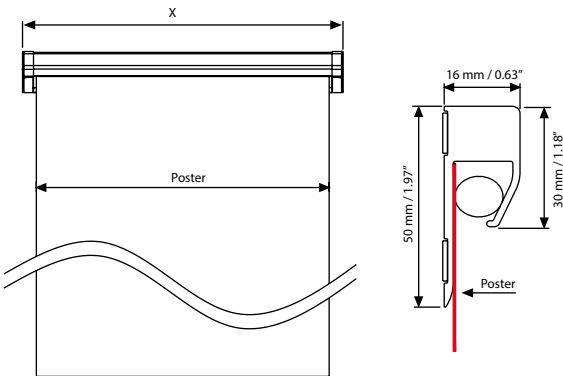

## ARTICLES

ARTICLE	EXTERNAL (x)	POSTER	WEIGHT	PACKING SIZE (50 pcs)
			WITH PACKING	*W X H X D
UFN000N031	335 mm	310 mm	8,000 kg	220 X 360 X 320 mm (50 pcs)
UFN000N050	525 mm	500 mm	12,900 kg	220 X 560 X 320 mm (50 pcs)
UFN000N058	605 mm	580 mm	14,400 kg	220 X 640 X 320 mm (50 pcs)
UFN000N088	905 mm	880 mm	11,000 kg	180 X 940 X 220 mm (25 pcs)
UFN000N100	1025 mm	1000 mm	12,000 kg	180 X 1060 X 220 mm (25 pcs)
UFN000N118	1205 mm	1180 mm	14,250 kg	180 X 1240 X 220 mm (25 pcs)
UFN000N150	1525 mm	1500 mm	18,000 kg	180 X 1560 X 220 mm (25 pcs)
UFN000N012	12.98"	12"	17,636 lbs	8.66" X 14.17" X 12.60" (50 pcs)
UFN000N024	24.98"	24"	35,273 lbs	8.66" X 26.38" X 12.60" (50 pcs)
UFN000N036	36.98"	36"	26,455 lbs	7.09" X 38.39" X 8.66" (25 pcs)
UFN000N040	40.98"	40"	28,660 lbs	7.09" X 42.32" X 8.66" (25 pcs)
UFN000N060	60.98"	60"	41,887 lbs	7.09" X 62.60" X 8.66" (25 pcs)

## PHYSICAL DATA

### Material

16x30x50mm silver anodised aluminium profile.

### Surface Finish

Silver anodized aluminium or custom colours available upon request with antimicrobial powder coating. Call for custom color requests.

### Recycled Content

Up to 80% recycled content used.

### Poster Material & Thickness

Suitable for various sizes of posters in thickness 0,1 - 0,8 mm for standard product. Any non-standard poster thicknesses should be indicated with order.

### Warranty

All products are guaranteed for 3 years by MT Displays with below conditions:

[Warranty Conditions](#)

### Installation Considerations

It is user friendly. Fixing set (screw and double-sided tape) and manual is supplied with each product. Suitable for use of posters / paper min. 0,1 mm, max. 0,8 mm thickness.

### Installation Considerations

It is user friendly, Fixing set (2 screws, 2 anchors and double-sided tape) and manual is supplied with each product. You can either assemble the product on the wall by fixing the holes on the profile with screws and wall-plugs or apply the double sided tape at any given point.

### Design Considerations

Suitable for silk screen printing, max. letter height is 14 mm.

### Cleaning and Disinfecting

Clean your displays, with damp microfiber clothes, rinsed with simply water or warm, soapy or gentle shampooed water. Avoid using vinegar, abrasive, acidic, alcohol-based or heavy cleaners or cleaners containing Ammonia. Only after cleaning the product, if needed, simply apply disinfectant or sanitizer that is in compliance with your local guidelines and regulations.

### Storage Conditions

Goods should be stored at 0° to 25°C in a dry place. Store in the original package.



T: +90 850 433 67 85 / info@mtdisplays.com / www.mtdisplays.com

# INSTALLATION INSTRUCTIONS

Fast Note / 1002005

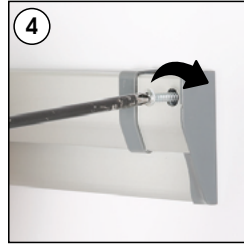
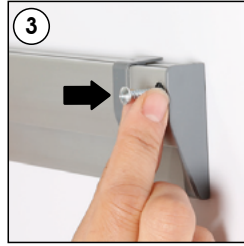
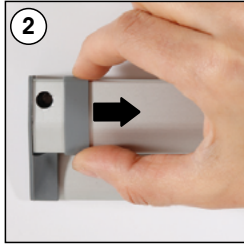
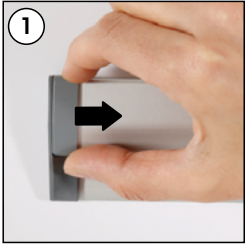

Screw & anchor mounting

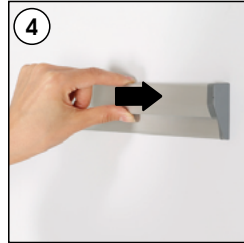
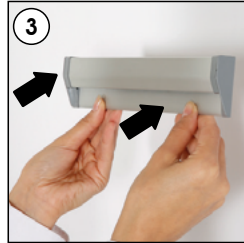
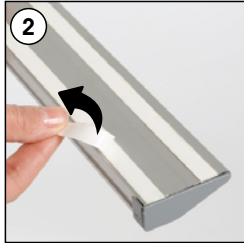
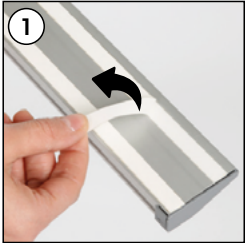

Double sided tape mounting

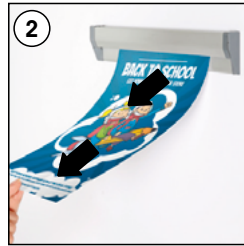

Attaching poster

Removing poster

Each Fast Note includes wall mounting accessories (2 screws & 2 anchors) and double sided tape

- Please inform the order number on the product or on the carton (e.g. 1/110001394-460) to the place that you have made the purchase if any problem with the product occurs.
- All rights reserved. All pictures, figures and writings are secured internationally by copy-right law. Infringements will be sued by civil and legal law.



This technical sheet's contents are all subject to update and modification at MT Displays' exclusive discretion. There is nothing official about this document. For final and legally binding information, please get in touch with the sales staff at MT Displays.



T: +90 850 433 67 85 / info@mtdisplays.com / www.mtdisplays.com