

FLEXIBLE MENUBOARD WITH FIXED HEIGHT



GENUINE DESIGN, ONE PRODUCT, MULTIFUNCTIONAL MENUBOARD

Genuine design, one product, 2 positions. With our newly designed product, we would like to bring a new dimension of performance in menuboards. The Flexible Menuboard fulfills multiple functions thanks to its paper position applications through various standing angles on the back. The landscape/portrait positioning and the eye catching view angle are all flexible. The product is protected worldwide by all required patent and design applications. It has already been certified in DE (Germany), FR (France), US (United States of America), JP (Japan) and OHIM (European union) papers. The worldwide patent is pending.

KEY SELECTION ATTRIBUTES

- * Genuine design with patent protection.
- * Multifunctional Menuboard, with two positions as portrait and landscape.
- * Suitable for poster sizes A3 and A4.
- * One set includes a powder coated decorative heavy base, aluminium profile body with height adjustment and a snap-open poster frame with angle adjustment.
- * Natural silver-anodized and various RAL colors available with antimicrobial powder coating.
- * The heavy base provides stability.
- * Packed unassembled in a sturdy box.



COLOURS IN STOCK COLOUR OPTIONS

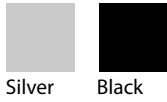

Silver Black

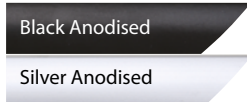

Black Anodised
Silver Anodised

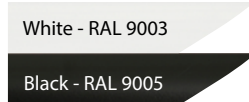

White - RAL 9003
Black - RAL 9005



Red - RAL 3020
Blue - RAL 5002



Green - RAL 6029
Yellow - RAL 1021

SUITABLE FOR

Menuboards can be used for INDOOR applications, for signage needs in highly frequented areas like shopping centers, markets, groceries, hotels, offices airports, shops and stores, hospitals, schools, apartments and many more.

WATCH VIDEO



Watch video at our website www.mtdisplays.com

FEATURES



EXPLODED VIEW

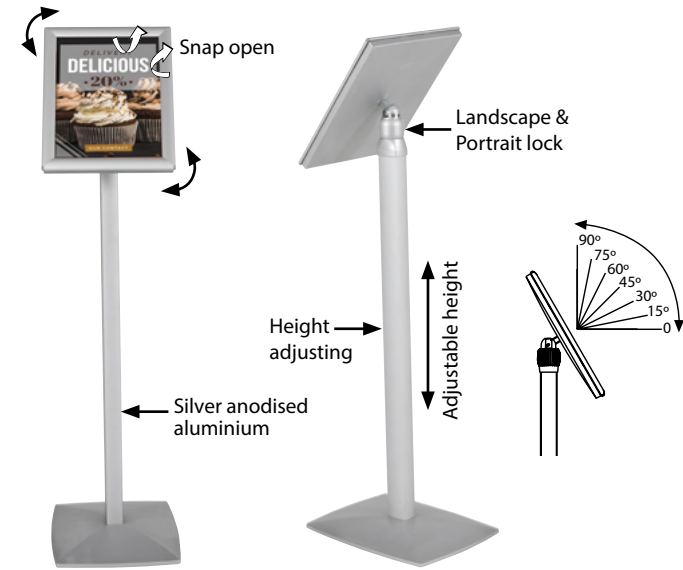

PHYSICAL DATA

Material

Aluminium profile body, 25mm snap-open aluminium profile poster frame, PET anti-reflex poster cover, PS backing or ABS backing.

Poster Material & Thickness

0,10 – 0,20 mm for standard product. Max poster thickness is 1,5 mm. any non-standard poster thicknesses should be indicated with order.

Surface Finish

Silver anodized or black colour, antimicrobial powder coating. Custom colors also available, call for custom color requests.

Recycled Content

Up to 78% recycled content used.

Warranty

All products are guaranteed for 3 years by MT Displays with below conditions:

[Warranty Conditions](#)

Installation Considerations

Menuboards are packed unassembled with an easy-to-understand instruction sheet & fixing elements. One set includes a durable heavy base, a height-adjustable body and a snap-open poster frame. Take the system into to the opened or closed position by turning the nut at the back of the frame. In the opened position, you can take the frame system both into the portrait or into the landscape position with a 15 degrees of angle gap. Heavy base provides stability in highly frequented areas.

Storage Conditions

Goods should be stored at 0° to 25°C in a dry place. Store in the original package.

Design Considerations

Suitable for silk screen printing, max. letter height is 15 mm.

TECHNICAL DRAWING

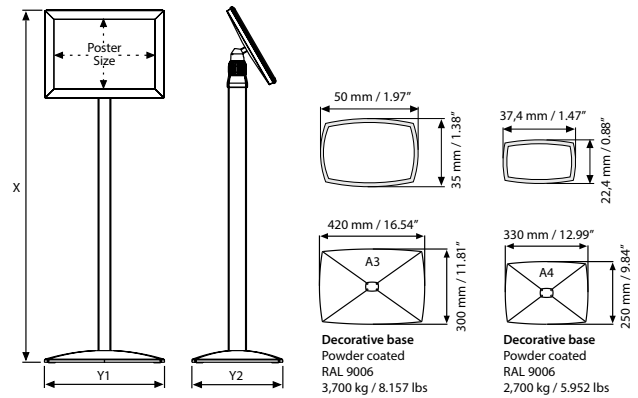

ARTICLES

ARTICLE	X	Y1	Y2	POSTER	DESCRIPTION	WEIGHT	PACKING SIZE
						WITH PACKING	*W X H X D
UDMB7005A4	967 mm	330 mm	250 mm	297 X 210 mm	Landscape	5,165 kg	285 X 1030 X 102 mm
	1010 mm	330 mm	250 mm	210 X 297 mm	Portrait	5,165 kg	285 X 1030 X 102 mm
UDMB7005A3	1014 mm	420 mm	300 mm	420 X 297 mm	Landscape	6,745 kg	365 X 1110 X 102 mm
	1076 mm	420 mm	300 mm	297 X 420 mm	Portrait	6,745 kg	365 X 1110 X 102 mm
UDMB700581	12.99"	9.84"	8.5"	8.5" X 11"	Landscape	11.166 lbs	11.22" X 40.55" X 4.02"
	12.99"	9.84"	8.5"	8.5" X 11"	Portrait	11.166 lbs	11.22" X 40.55" X 4.02"
UDMB700517	16.54"	11.81"	11"	11" X 17"	Landscape	14.870 lbs	14.37" X 43.70" X 4.02"
	16.54"	11.81"	11"	11" X 17"	Portrait	14.870 lbs	14.37" X 43.70" X 4.02"
UDMB700518	16.54"	11.81"	18"	18" X 22"	Landscape	17.196 lbs	20.67" X 52.36" X 4.06"
	16.54"	11.81"	18"	18" X 22"	Portrait	17.196 lbs	20.67" X 52.36" X 4.06"

Cleaning and Disinfecting

Clean your displays, with damp microfiber clothes, rinsed with simply water or warm, soapy or gentle shampooed water. Avoid using vinegar, abrasive, acidic, alcohol-based or heavy cleaners or cleaners containing Ammonia. Only after cleaning the product, if needed, simply apply disinfectant or sanitizer that is in compliance with your local guidelines and regulations.

Patent

Patent : TR 2007 06354 - TR 2007 03453 - PCT/TR 2007/000131 - DE 20 2007 016 574 - OHIM 000748223-0001,2 - FR 760305 - US 29/295.750 - US D 597, 764 S - JP 2007-022472- JP 2007-022473 - CN 200730321542.4 - CN 200730321543.



T: +90 850 433 67 85 / info@mtdisplays.com / www.mtdisplays.com

PRINT TEMPLATES

Flexible Menuboard with Fixed Height - A4
 Document Size: 220 x 307 mm (Includes Bleeds)
 Finished Size: A4 (210 x 297 mm) [Print](#)

Flexible Menuboard with Fixed Height - 8.5"x11"
 Document Size: 8.89" x 11.4" (Includes Bleeds)
 Finished Size: 8.5" x 11" (215.9 x 279.4 mm)

Flexible Menuboard with Fixed Height - 18"x22"
 Document Size: 18.4" x 22.4" (Includes Bleeds)
 Finished Size: 18" x 22" (457.2 x 558.8 mm)

Flexible Menuboard with Fixed Height - A3
 Document Size: 307 x 430 mm (Includes Bleeds)
 Finished Size: A3 (297 x 420 mm) [Print](#)

Flexible Menuboard with Fixed Height - 11"x17"
 Document Size: 11.4" x 17.4" (Includes Bleeds)
 Finished Size: 11" x 17" (279.4 x 431.8 mm)

INSTALLATION INSTRUCTIONS

Flexible Menuboard with Fixed Height/ 1002043

- Each product includes
- 1 x Main body profile
 - 1 x Base
 - 1 x Opti Frame
 - 1 x PET cover
 - 4 x Bolt M5x50
 - 1 x 4 allen key

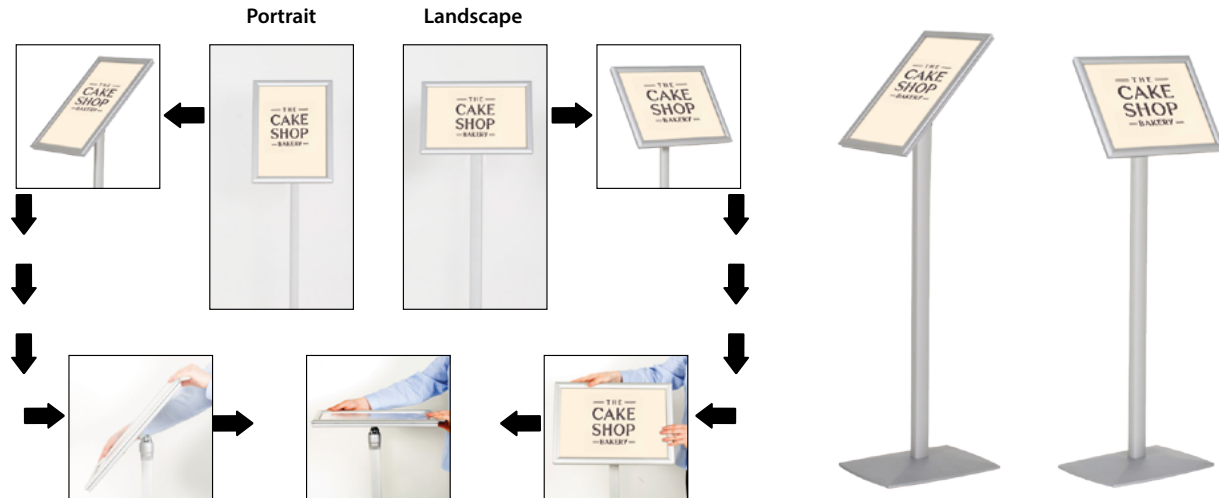
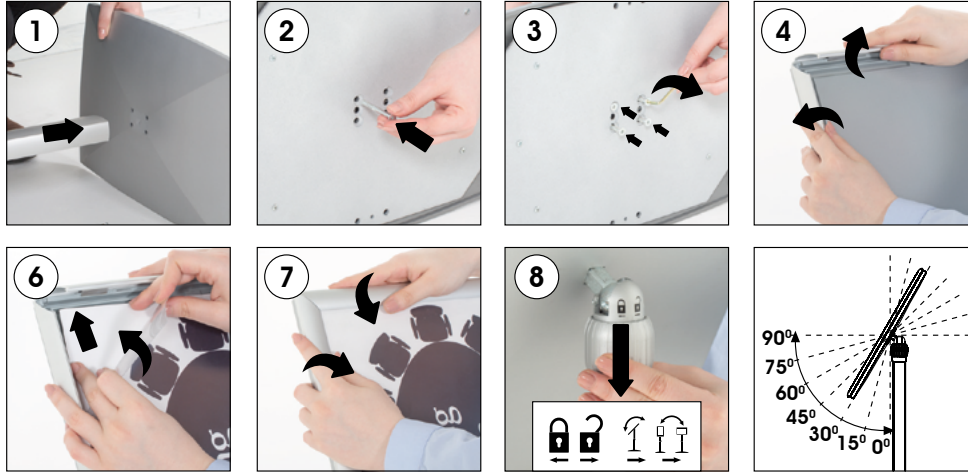

- Please inform the order number on the product or on the carton (e.g. 1/110001394-460) to the place that you have made the purchase if any problem with the product occurs.
- All rights reserved. All pictures, figures and writings are secured internationally by copy-right law. Infringements will be sued by civil and legal law.

This technical sheet's contents are all subject to update and modification at MT Displays' exclusive discretion. There is nothing official about this document. For final and legally binding information, please get in touch with the sales staff at MT Displays.



T: +90 850 433 67 85 / info@mtdisplays.com / www.mtdisplays.com