

## FLEXIBLE MENUBOARD WITH LEDBOX



### GENUINE DESIGN MENUBOARDS ILLUMINATED WITH LED TECHNOLOGY

Genuine design, one product, multi function. Flexible Menuboard with Ledbox bring a new dimension of performance in menuboards. LED technology illuminates prints homogeneous. It is in multi functional service of height and paper position application with variety of standing angles at the back. The height of the unit, landscape/portrait positioning or even eye catching view angle is flexible. Silver and black models are available in A4&A3 sizes. The product is protected in world with all required patent and design applications and already certified with DE (Germany), FR(France), US (United States of America), JP (Japan) and OHIM (European union) papers. PCT worldwide patent is pending.

### KEY SELECTION ATTRIBUTES

- \* Genuine design with patent protection.
- \* Multifunctional Menuboard, with two positions as portrait and landscape.
- \* Suitable for poster sizes A3 and A4.
- \* One set includes a powder coated decorative heavy base, aluminium profile body with a fastener for height adjustment and a snap-open poster frame with angle adjustment and LED technology for illuminating prints homogeneously.
- \* Natural silver-anodized, black and various RAL colors available with antimicrobial powder coating.
- \* The heavy base provides stability.
- \* Packed unassembled in a sturdy box.



## COLOURS IN STOCK

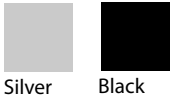

Silver Black

## SUITABLE FOR

Menuboards can be used for INDOOR applications, for signage needs in highly frequented areas like shopping centers, markets, groceries, hotels, offices airports, shops and stores, hospitals, schools, apartments and many more.

## WATCH VIDEO



Watch video at our website  
www.mtdisplays.com

## FEATURES



## EXPLODED VIEW

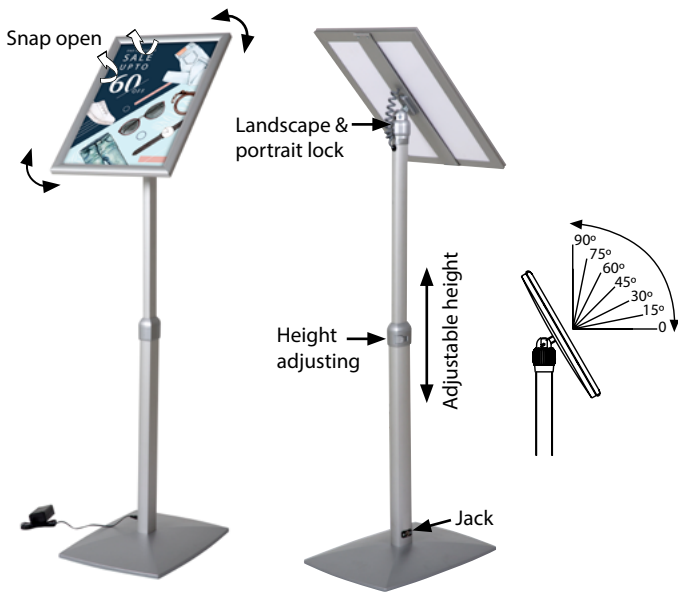

## TECHNICAL DRAWING

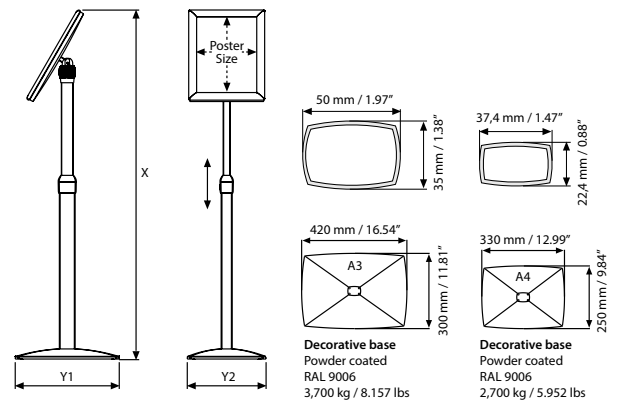

## ARTICLES

ARTICLE	X max.	X min.	Y1	Y2	POSTER	DESCRIPTION	LIGHTING	WEIGHT	PACKING SIZE
								WITH PACKING	*W X H X D
UFML00N0A4	1205 mm	865 mm	330 mm	250 mm	297 X 210 mm	Silver Landscape	3000-3300 W	5,970 kg	285 X 1030 X 102 mm
	1250 mm	910 mm	330 mm	250 mm	210 X 297 mm	Silver Portrait	3000-3300 W	5,970 kg	285 X 1030 X 102 mm
UFML00N0A3	1250 mm	910 mm	420 mm	300 mm	420 X 297 mm	Silver Landscape	2800-3000 W	8,220 kg	365 X 1110 X 102 mm
	1310 mm	910 mm	420 mm	300 mm	297 X 420 mm	Silver Portrait	2800-3000 W	8,220 kg	365 X 1110 X 102 mm
UFML10B0A4	fixed height	fixed height	330 mm	250 mm	297 X 210 mm	Black Landscape	3000-3300 W	5,970 kg	285 X 1030 X 102 mm
	fixed height	fixed height	330 mm	250 mm	210 X 297 mm	Black Portrait	3000-3300 W	5,970 kg	285 X 1030 X 102 mm
UFML10B0A3	fixed height	fixed height	420 mm	300 mm	420 X 297 mm	Black Landscape	2800-3000 W	8,220 kg	365 X 1110 X 102 mm
	fixed height	fixed height	420 mm	300 mm	297 X 420 mm	Black Portrait	2800-3000 W	8,220 kg	365 X 1110 X 102 mm
UFML00N017	48.50"	35.12"	16.54"	11.81"	11" X 17"	Silver Landscape	1800-2200 LUX	19.841 lbs	14.57" X 50.79" X 6.10"
	52.05"	36.30"	16.54"	11.81"	11" X 17"	Silver Portrait	1800-2200 LUX	19.841 lbs	14.57" X 50.79" X 6.10"
UFML00N018	55.63"	42.24"	16.54"	11.81"	18" X 24"	Silver Landscape	1800-2100 LUX	15.432 lbs	20.67" X 52.36" X 4.06"
	59.06"	43.31"	16.54"	11.81"	18" X 24"	Silver Portrait	1700-2100 LUX	15.432 lbs	20.67" X 52.36" X 4.06"



T: +90 850 433 67 85 / info@mtdisplays.com / www.mtdisplays.com

## PHYSICAL DATA

### Material

Aluminium profile body, 25mm snap-open aluminium profile poster frame, PET anti-reflex poster cover, PS backing or ABS backing.

### Poster Material & Thickness

0,10 – 0,20 mm for standard product. Max poster thickness is 2 mm. any non-standard poster thicknesses should be indicated with order.

### Surface Finish

Silver anodized or black colour, antimicrobial powder coating. Custom colors also available, call for custom color requests.

### Recycled Content

Up to 78% recycled content used.

### Warranty

All products are guaranteed for 3 years by MT Displays with below conditions:

[Warranty Conditions](#)

### Installation Considerations

Menuboards are packed unassembled in a sturdy box with an easy-to-understand instruction sheet & fixing elements. One set includes a snap-open poster frame with angle adjustment and LED technology for illuminating prints homogeneously, an aluminium profile body with a fastener for height adjustment and a jack at the bottom for plugging power supply, a powder coated decorative heavy base. Take the system into the opened or closed position by turning the nut at the back of the frame. In the opened position, you can take the frame system both into the portrait or into the landscape position with a 15 degrees of angle gap.

### Storage Conditions

Goods should be stored at 0° to 25°C in a dry place. Store in the original package.

### Design Considerations

Genuine design with patent protection. Suitable for silk screen printing, max. letter height is 15 mm. LED technology illuminates the posters and papers.

Suitable for A3 and A4 poster sizes in Landscape and Portrait positions with a flexible sight angle that catches the eye level. The heavy elegant base provides stability in highly frequented areas.

### Cleaning and Disinfecting

Clean your displays, with damp microfiber clothes, rinsed with simply water or warm, soapy or gentle shampooed water. Avoid using vinegar, abrasive, acidic, alcohol-based or heavy cleaners or cleaners containing Ammonia. Only after cleaning the product, if needed, simply apply disinfectant or sanitizer that is in compliance with your local guidelines and regulations.

### Patent

Patent : TR 2007 06354 - TR 2007 03453 - PCT/TR 2007/000131 - DE 20 2007 016 574 - OHIM 000748223-0001,2 - FR 760305 - US 29/295.750 - US D 597, 764 S - JP 2007-022472- JP 2007-022473 - CN 200730321542.4 - CN 200730321543.

## PRINT TEMPLATES

### Flexible Menuboard with Fixed Height - A4

Document Size: 220 x 307 mm (Includes Bleeds)

Finished Size: A4 (210 x 297 mm) [Print](#)

### Flexible Menuboard with Fixed Height - A3

Document Size: 307 x 430 mm (Includes Bleeds)

Finished Size: A3 (297 x 420 mm) [Print](#)

### Flexible Menuboard with Fixed Height - 11"x17"

Document Size: 11.4" x 17.4" (Includes Bleeds)

Finished Size: 11" x 17" (279.4 x 431.8 mm)

### Flexible Menuboard with Fixed Height - 18"x24"

Document Size: 18.4" x 22.4" (Includes Bleeds)

Finished Size: 18" x 22" (457.2 x 558.8 mm)

## ILLUMINATED PRODUCTS TECHNICAL MANUAL

### POWER SUPPLY

- 12 V DC
- Complete with power supply
- 2 year guaranteed
- 7/16 use
- If 7/24 use required, please order individually.

### CABLE

Delivered with 2,5 meter long cable and EU plug. UK, US or CH plugs should be specified with order. Extension cable: 1 mm, 2 mm, 3 mm.



### TECHNICAL SPECIFICATION

CORK	POSTER	DESCRIPTION	ILLUMINATION	POWER CONSUMPTION	POWER SUPPLY RECOMMENDED
UFMLO0N0A4	210 X 297 mm	Flexible height - Silver	3000-3300 W	7 W / 0.58 A	1 A
UFMLO0N0A3	420 X 297 mm	Flexible height - Silver	2800-3000 W	11 W / 0.91 A	1 A
UFML10B0A4	210 X 297 mm	Fixed height - Black	3000-3300 W	7 W / 0.58 A	1 A
UFML10B0A3	420 X 297 mm	Fixed height - Black	2800-3000 W	11 W / 0.91 A	1 A

### FEATURES

- Halo effect around the frame.
- Improved Led technology for improved luminance.
- Pre-treated light guided panel diffuses light even & powerful.
- Saves up to 60% energy costs.
- CE certificate provided..

### LED FEATURES (Duris E5)

Viewing angle at 50 % IV: 120°

Color: 2700 K - 6500 K ( white )

CRI: Min. 80 ( typ. 85 )

Luminous Flux: Typ. 56 lm @ 5000 K

Luminous efficacy: Typ. 156 lm/W @ 5000 K

Luminous efficacy @ 65m A: Typ. 170 lm/W @ 5000K

Lumen Maintenance: Testing according to

IESNA LM-80 in progress

Life Time : 50.000 Hours

Colour: 5700 K -6500 K (White)\*

\*For special inquired colour is available in 2700 K -6500 K



### ASSEMBLY SHEET



# INSTALLATION INSTRUCTIONS

## Flexible Menuboard with LEDbox / 1005992

**Each product includes**

- 1 x Main body profile
- 1 x Base
- 1 x Best Buy LEDbox Frame
- 1 x PET cover
- 4 x Bolt M5x50
- 1 x 4 allen key
- 1 x Power Supply 12V-1A

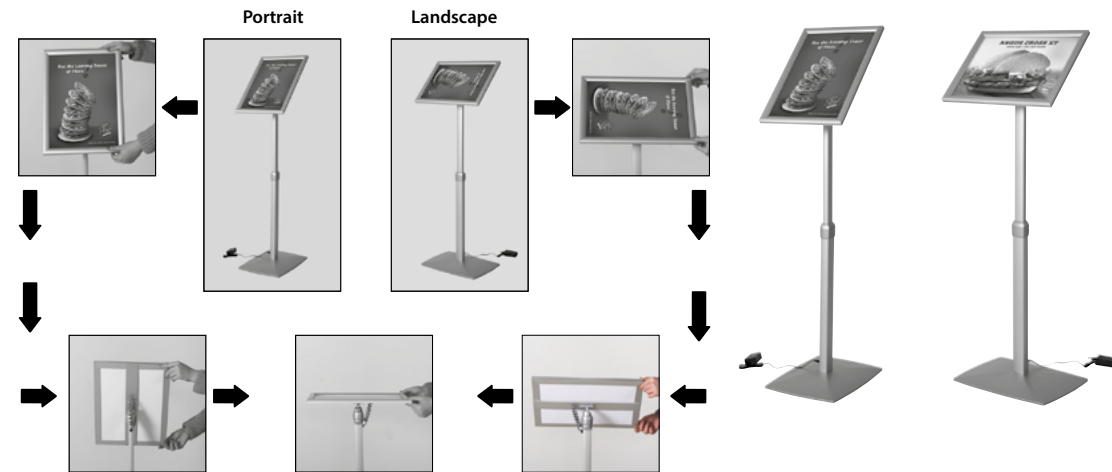
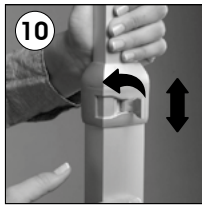
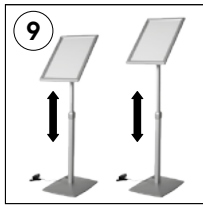
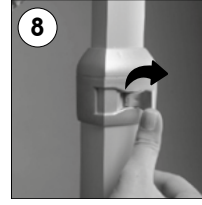
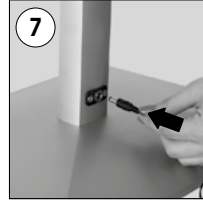
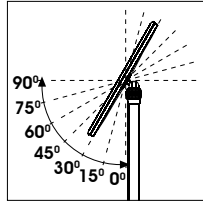
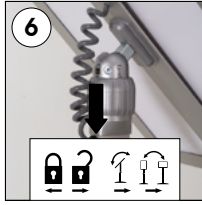
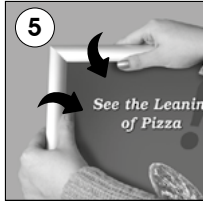
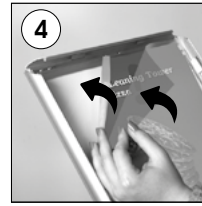
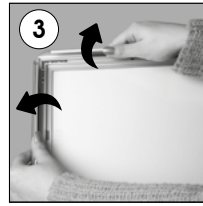
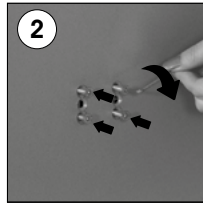
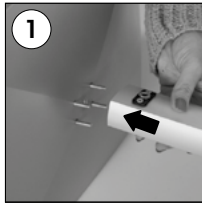

- Please inform the order number on the product or on the carton (e.g. 1/110001394-460) to the place that you have made the purchase if any problem with the product occurs.
- All rights reserved. All pictures, figures and writings are secured internationally by copy-right law. Infringements will be sued by civil and legal law.

This technical sheet's contents are all subject to update and modification at MT Displays' exclusive discretion. There is nothing official about this document. For final and legally binding information, please get in touch with the sales staff at MT Displays.



T: +90 850 433 67 85 / info@mtdisplays.com / www.mtdisplays.com