

## FOLDER MENUBOARD



## FLOOR STANDS WITH ACRYLIC SHELF FOR PRESENTING MENUS, PROMOTIONS AND NOTES

The Folder Menuboard has a transparent acrylic shelf catching the eye level. It has a ring binder available to hold 2xA4 individual menu pages. With the usage of the channeled elliptic profile and any acrylic or steel shelf, a frame can quickly reveal the advantages of the product.

### KEY SELECTION ATTRIBUTES

- \* Folder Menuboard with optional brochure holders.
- \* Ideal for use as a ring binder to hold 2xA4 individual menu pages.
- \* One set includes a heavy decorative base, a double-channeled aluminium ellipse profile body and a transparent acrylic or steel shelf with a ring binder at a sight angle that catches the eye level.
- \* Additional snap frames, leaflet dispensers and metal shelves can be used with the product. Additional parts are not included in package, should be ordered separately.

- \* Natural silver-anodized, black or various RAL colors available with antimicrobial powder coating.
- \* The durable base provides stability.
- \* Packed unassembled in a sturdy box.



Silver



Black



## COLOURS IN STOCK

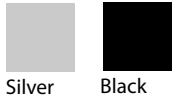

Silver Black

## SUITABLE FOR

Menuboards can be used for INDOOR applications, for signage needs in many locations like shopping centers, markets, groceries, hotels, offices airports, shops and stores, hospitals, schools, apartments and many more.

## WATCH VIDEO



Watch video at our website  
www.mtdisplays.com

## FEATURES



## EXPLODED VIEW

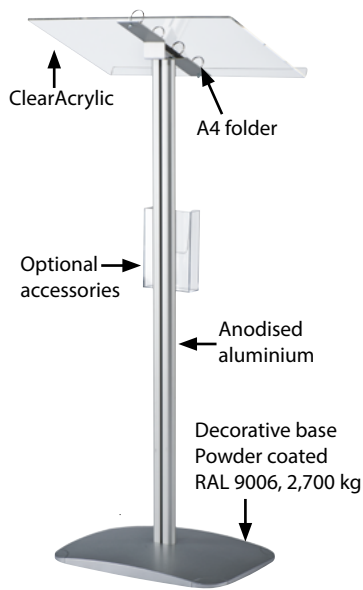

## TECHNICAL DRAWING

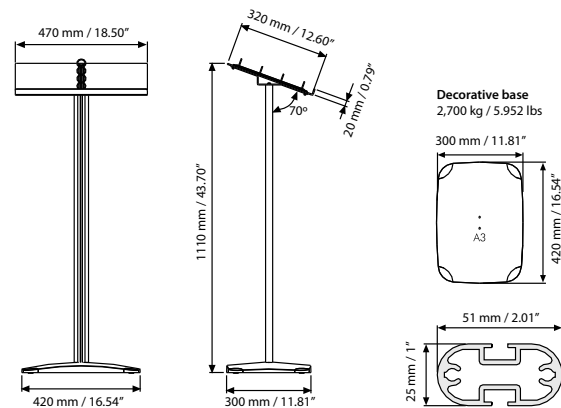

Some possible Variations

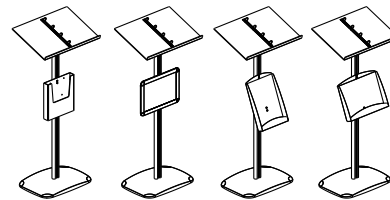

## ARTICLES

ARTICLE	CAPACITY	DESCRIPTION	WEIGHT	PACKING SIZE
			WITH PACKING	*W X H X D
UDMB2002A4	2 X A4	Silver	6,850 kg	380 X 1070 X 50 mm
UDMB2B02A4	2 X A4	Black	6,850 kg	380 X 1070 X 50 mm

SHELF			WEIGHT	PACKING SIZE
ARTICLE	CAPACITY	DESCRIPTION	WITH PACKING	*W X H X D
UFSL002100	2 X A5	Steel shelf	1,485 kg	340 X 290 X 63 mm
UFSL003100	2 X A5	Acrylic shelf	0,890 kg	340 X 290 X 63 mm
UFSL002200	1 X A4	Steel shelf	1,165 kg	250 X 370 X 63 mm
UFSL003200	1 X A4	Acrylic shelf	0,810 kg	250 X 370 X 63 mm
UFSL003300	1 X (8.5"x11")	Acrylic shelf	0,610 kg	240 X 270 X 55 mm

## OPTIONAL ACCESSORIES



2x A5 Steel shelf for Free Standing Leaflet & Adjustable menuboard.  
UFSL002100



2x A5 Acrylic shelf for Free Standing Leaflet & Adjustable menuboard.  
UFSL003100



1x A4 Steel shelf for Free Standing Leaflet.  
UFSL002200



1x A4 Acrylic shelf for Free Standing Leaflet.  
UFSL003200



1x A4 Acrylic shelf for Free Standing.  
UFSL003300



T: +90 850 433 67 85 / info@mtdisplays.com / www.mtdisplays.com

## PHYSICAL DATA

### Material

25x51mm double channel aluminium ellipse profile body, transparent acrylic or steel shelf with ring binder. Steel or acrylic optional shelves.

### Surface Finish

Silver anodized or black colour, antimicrobial powder coating. Custom colors also available, call for custom color requests.

### Recycled Content

Up to 78% recycled content used.

### Warranty

All products are guaranteed for 3 years by MT Displays with below conditions:

[Warranty Conditions](#)

### Installation Considerations

Folder Menuboards are packed unassembled in a sturdy box with an easy-to-understand instruction sheet & fixing elements. One set includes a heavy durable base for stability, a double-channeled aluminium ellipse profile body and a transparent acrylic or steel shelf with a ring binder at a sight angle that catches the eye level. Additional, optional parts are not included in package, should be ordered separately.

### Storage Conditions

Goods should be stored at 0° to 25°C in a dry place. Store in the original package.

### Design Considerations

Suitable for use as a ring binder to hold 2xA4 individual menu pages. The decorative base with an elegant look. Optional snap frames, leaflet dispensers and metal shelves can be added to the leg of the product.

### Cleaning and Disinfecting

Clean your displays, with damp microfiber clothes, rinsed with simply water or warm, soapy or gentle shampooed water. Avoid using vinegar, abrasive, acidic, alcohol-based or heavy cleaners or cleaners containing Ammonia. Only after cleaning the product, if needed, simply apply disinfectant or sanitizer that is in compliance with your local guidelines and regulations.

## INSTALLATION INSTRUCTIONS

### Folder Menuboard / 1004888

#### Each product includes

- 1 x Main body profile
- 1 x Base
- 1 x Acrylic Folder 2xA4
- 1 x Aluminium connecting plate
- 1 x A4 file holder
- 1 x 4 allen key
- 2 x Bolt M6x50
- 2 x Bolt M4x12
- 2 x Bolt M6x25
- 2 x Nut M4

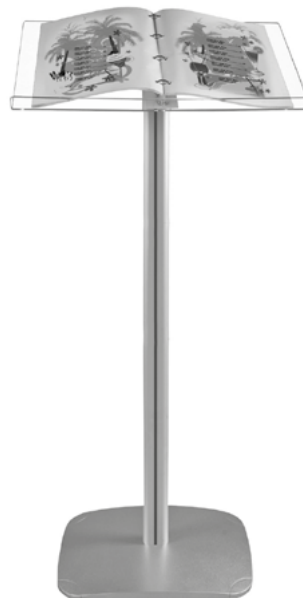
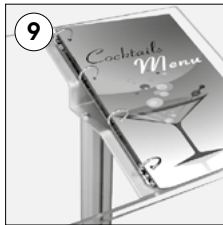
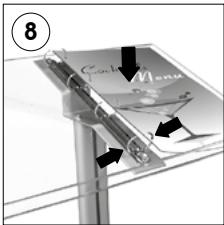
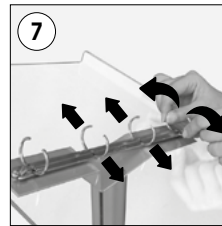
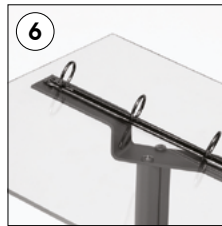
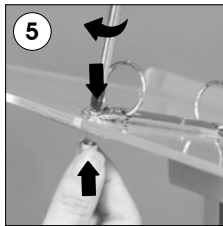
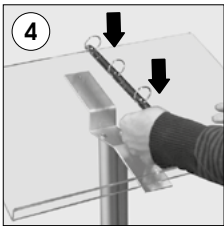
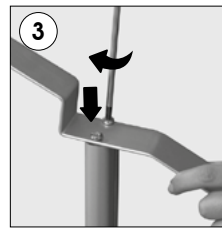
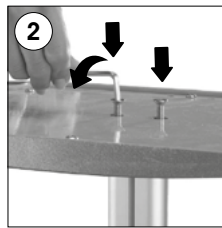
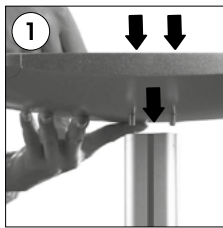

- Please inform the order number on the product or on the carton (e.g. 1/110001394-460) to the place that you have made the purchase if any problem with the product occurs.
- All rights reserved. All pictures, figures and writings are secured internationally by copy-right law. Infringements will be sued by civil and legal law.

This technical sheet's contents are all subject to update and modification at MT Displays' exclusive discretion. There is nothing official about this document. For final and legally binding information, please get in touch with the sales staff at MT Displays.



T: +90 850 433 67 85 / [info@mtdisplays.com](mailto:info@mtdisplays.com) / [www.mtdisplays.com](http://www.mtdisplays.com)