

INFOBOARD



SINGLE OR DOUBLE SIDED SIDEWALK SIGNS WITH EASY SNAP OPEN DESIGN

Single faced acrylic shelves and wheels can be added to the info boards. An anti-reflex PET cover is presented in each unit. 32 mm profile snap frame is used.

KEY SELECTION ATTRIBUTES

*32 mm round corner single or double-sided info boards works with a snap-open frame design that enabling easy poster changes by simply opening the side profiles for front-loading.

* Suitable for INDOOR public spaces with poster sizes A1 (594x841 mm), B2 (500x700 mm) and B1 (700x1000 mm).

* Single sided set includes 32mm Snap frame with round corners for displaying posters on one side, one anti-reflex PET poster cover, PS backing, 25x51 mm anodised aluminium profile main body with round corners and 1760 mm height, two feet with 450mm length for stability, allen keys and screws for fixing.

* Double sided set includes 32mm Snap frames with round corners for displaying posters on double sides, two anti-reflex PET poster covers, PS

backing, 25x51 mm anodised aluminium profile main body with round corners and 1760 mm height, two feet with 450mm length for stability, allen keys and screws for fixing.

* The PS backing in the middle of 2 posters prevent light transmission.

* Natural silver-anodized in standard and various RAL colors available with antimicrobial powder coating.

* The product is packed unassembled with an easy-to understand instruction sheet & fixing elements.

* Wheels are optional, not included in standard packing. Acrylic shelves are optional in single sided or double sided versions. If needed, please order separately.

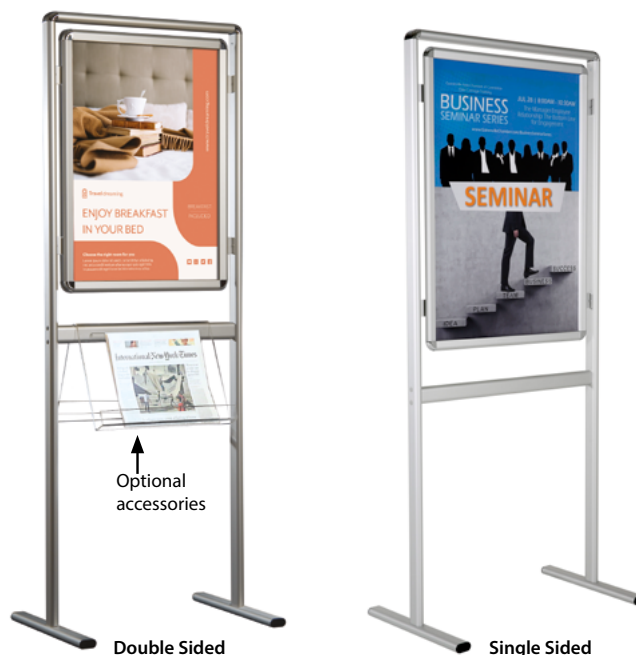

COLOURS IN STOCK



Silver

COLOUR OPTIONS

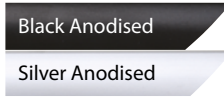

Black Anodised

Silver Anodised

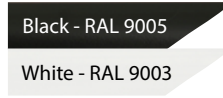

Black - RAL 9005

White - RAL 9003



Red - RAL 3020

Blue - RAL 5002



Green - RAL 6029

Yellow - RAL 1021

CORNER TYPES

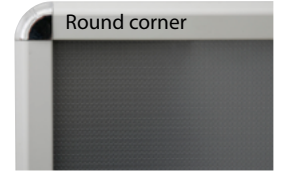

SUITABLE FOR

Infoboard can be used for INDOOR applications, for signage needs in public areas like shopping centers, markets, groceries, hotels, offices airports, shops and stores, hospitals, schools, apartments, restaurants, halls, meeting rooms, gas stations and many more.

FEATURES



EXPLODED VIEW



TECHNICAL DRAWING

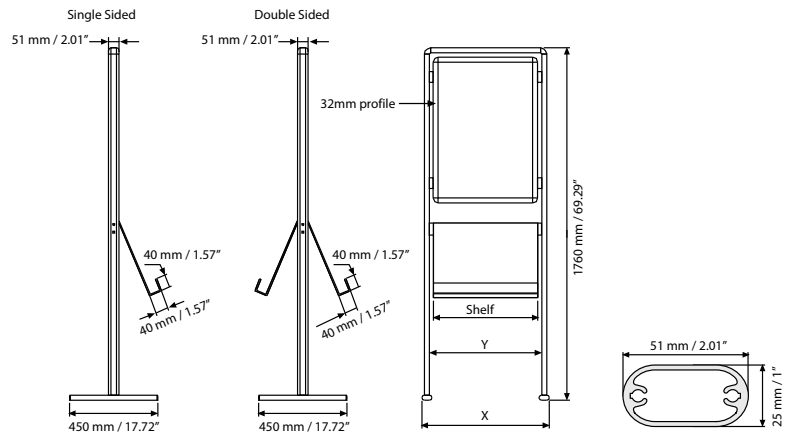

ARTICLES

SINGLE SIDED				WEIGHT	PACKING SIZE
ARTICLE	POSTER	X	Y		
UIB200TNA1	594 X 841 mm	756 mm	680 mm	8,800kg	770 X 1780 X 70 mm
UIB200TNB2	500 X 700 mm	660 mm	584 mm	8,000 kg	660 X 1780 X 70 mm
UIB200TNB1	700 X 1000 mm	860 mm	784 mm	11,000 kg	870 X 1780 X 70 mm
UIB200TN18	18" X 24"	24.33"	27.32"	17.636 lbs	24.41" X 68.90" X 2.56"
UIB200TN22	22" X 28"	28.35"	31.34"	20.943 lbs	28.35" X 69.29" X 2.36"

WEIGHT	PACKING SIZE
WITH PACKING	*W X H X D
8,800kg	770 X 1780 X 70 mm
8,000 kg	660 X 1780 X 70 mm
11,000 kg	870 X 1780 X 70 mm
17.636 lbs	24.41" X 68.90" X 2.56"
20.943 lbs	28.35" X 69.29" X 2.36"

DOUBLE SIDED				WEIGHT	PACKING SIZE
ARTICLE	POSTER	X	Y		
UIB200CNA1	594 X 841 mm	756 mm	680 mm	11,100 kg	770 X 1780 X 70 mm
UIB200CNB2	500 X 700 mm	660 mm	584 mm	9,500 kg	660 X 1780 X 70 mm
UIB200CNB1	700 X 1000 mm	860 mm	784 mm	13,750 kg	870 X 1780 X 70 mm
UIB200CN18	18" X 24"	24.33"	27.32"	20.943 lbs	24.41" X 68.90" X 2.56"
UIB200CN22	22" X 28"	28.35"	31.34"	22.928 lbs	28.35" X 69.29" X 2.36"

WEIGHT	PACKING SIZE
WITH PACKING	*W X H X D
11,100 kg	770 X 1780 X 70 mm
9,500 kg	660 X 1780 X 70 mm
13,750 kg	870 X 1780 X 70 mm
20.943 lbs	24.41" X 68.90" X 2.56"
22.928 lbs	28.35" X 69.29" X 2.36"

OPTIONAL ACCESSORIES

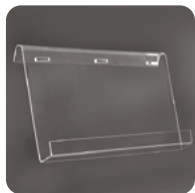

SHELF : 4 mm acrylic	
SINGLE SIDED	MAX. CAPACITY
UYRT0003A4	3 X A4
UYRT0002A4	2 X A4
UYRT0003A4	3 X A4

Single sided acrylic shelves for Infoboard and brochure sets.

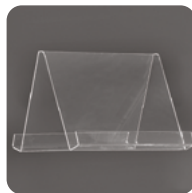

SHELF : 4 mm acrylic	
DOUBLE SIDED	MAX. CAPACITY
UYRC0003A4	6 X A4
UYRC0002A4	4 X A4
UYRC0003A4	6 X A4

Double sided acrylic shelves for Infoboard and brochure sets.



T: +90 850 433 67 85 / info@mtdisplays.com / www.mtdisplays.com

PHYSICAL DATA

Material

32 mm snap-open aluminium profile poster frame, 25x51mm aluminium profile main body and feet, PET anti-reflex poster cover and PS backing.

Poster Thickness

0,10 - 2,00 mm for standard product. Max poster thickness is 2,00 mm for low density rigid posters such as PVC Foam, PP and etc. When rear profile is without channel/grove, it is max 3,00 mm for low density rigid posters such as PVC Foam, PP and etc. Any non-standard poster thickness should be indicated with the order.

Surface Finish

Natural silver-anodized in standard and various RAL colors available with antimicrobial powder coating. Call for custom color requests.

Recycled Content

Up to 78% recycled content used.

Warranty

All products are guaranteed for 3 years by MT Displays with below conditions:

[Warranty Conditions](#)

Storage Conditions

Goods should be stored at 0° to 25°C in a dry place. Store in the original package.

Installation Considerations

Infoboards are packed unassembled with an easy-to-understand instruction sheet & fixing elements. Single sided set includes 32mm Snap frame with round corners for displaying posters on one side, one anti-reflex PET poster cover, PS backing, 25x51 mm anodised aluminium profile main body with round corners and 1760 mm height, two feet with 450mm length for stability, allen keys and screws for fixing. Double sided set includes 32mm Snap frames with round corners for displaying posters on double sides, two anti-reflex PET poster covers, PS backing, 25x51 mm anodised aluminium profile main body with round corners and 1760 mm height, two feet with 450mm length for stability, allen keys and screws for fixing. Wheels are optional, not included in standard packing. Acrylic shelves are optional in single sided or double sided versions. If needed, please order separately.

Design Considerations

Single or Double-sided Info Boards with Snap-open frame for easy poster changing by simply opening the side profiles for front-loading. Suitable for INDOOR public spaces with poster sizes A1 (594x841 mm), B2 (500x700 mm) and B1 (700x1000 mm). The PS backing in the middle of 2 posters prevent light transmission. Long feet provides stability.

Cleaning and Disinfecting

Clean your displays, with damp microfiber clothes, rinsed with simply water or warm, soapy or gentle shampooed water. Avoid using vinegar, abrasive, acidic, alcohol-based or heavy cleaners or cleaners containing Ammonia. Only after cleaning the product, if needed, simply apply disinfectant or sanitizer that is in compliance with your local guidelines and regulations. should be ordered separately.

PRINT TEMPLATES

Infoboard - A1

Document Size: 604 x 851 mm (Includes Bleeds)
Finished Size: A1 (594 x 841 mm) [Print](#)

Infoboard - B2

Document Size: 510 x 710 mm (Includes Bleeds)
Finished Size: B2 (500 x 700 mm) [Print](#)

Infoboard - B1

Document Size: 710 x 1010 mm (Includes Bleeds)
Finished Size: B1 (700 x 1000 mm) [Print](#)

Infoboard - 18"x24"

Document Size: 18.4" x 24.4" (Includes Bleeds)
Finished Size: 18"x24" (457.2x609.6 mm)

Infoboard - 22"x28"

Document Size: 22.4" x 28.4" (Includes Bleeds)
Finished Size: 22"x28" (558.8x711.1 mm)

INSTALLATION INSTRUCTIONS

Infoboard / 1001891

- Each product includes mounting accessories
- 2 x Feet
 - 1 x Main body
 - 1 x 5 Allen key
 - 4 x Screw
 - PET cover
 - 1 x for single sided model
 - 2 x for double sided model

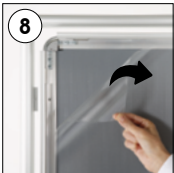
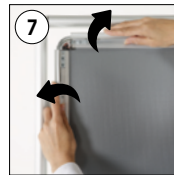
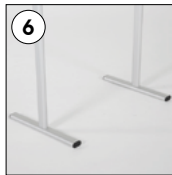
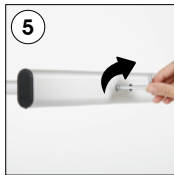
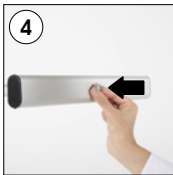
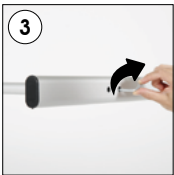
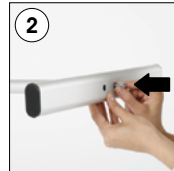
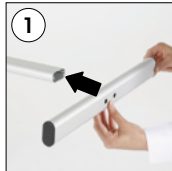

This technical sheet's contents are all subject to update and modification at MT Displays' exclusive discretion. There is nothing official about this document. For final and legally binding information, please get in touch with the sales staff at MT Displays.

