

## MULTISIDE BROCHURE SET 3 POLE



### BROCHURE HOLDERS FOR MULTIPLE VARIATIONS OF ACRYLIC SHELVES

Multiside Brochure sets are developed to provide multiple variations at low costs. Based on 3 pole or 4 pole robust aluminum body at height of 1,5 meters, different number of shelves can be fitted to make a brochure set which meets your exact needs. To complete a product, main body and required quantities of shelves need to be ordered separately. Brochure holders are quickly and easily inserted.

### KEY SELECTION ATTRIBUTES

- \* Free standing, three sided and decorative brochure holder sets for meeting different needs by utilizing multiple variations of acrylic shelves at low cost.
- \* Suitable for INDOOR public spaces with capacity of holding 5 shelves on each pole for A5, A4, 1/3A4 and 2 x 1/3A4 brochure sizes.
- \* One main body set includes 3 robust poles made from 35x22 mm anodised aluminium profiles with 1500 mm height and channels on each pole, 1 decorative base made from 370x423mm metallic gray RAL 9006 powder coated steel with 6mm thickness and 5,60 kg weight for stability; 4 plastic feet under the base; 15 brochure holder shelf connector (adapter).
- \* To complete a product, main body and required quantities of shelves need to be ordered separately. Brochure holders are quickly and easily inserted. Each pole is available to carry 5 brochure holders.
- \* Please gently push the shelves over the connectors on the pole. The shelf connectors arrive at fixed positions. For individual adjustment please loosen the screws to move up and down. UMSD008100 and UYUP490000 can be used to form UMSDA005A4 if you have them in your stock.
- \* Heavy & stable base for public spaces.
- \* Natural silver-anodized main body profile, metallic gray powder coated steel base and transparent shelf in standard. Custom colors also available, call for custom color requests.
- \* Main body of Multiside Brochure Set is packed unassembled in 2 boxes with an easy-to understand instruction sheet & fixing elements. See info chart for pack sizes.



## COLOURS IN STOCK



Silver

## SUITABLE FOR

Multiside Brochure Sets can be used for INDOOR applications, for displaying brochures in many locations like shopping centers, markets, groceries, hotels, offices airports, shops and stores, hospitals, schools, apartments, restaurants, halls, meeting rooms, gas stations and many more.

## FEATURES



## EXPLODED VIEW

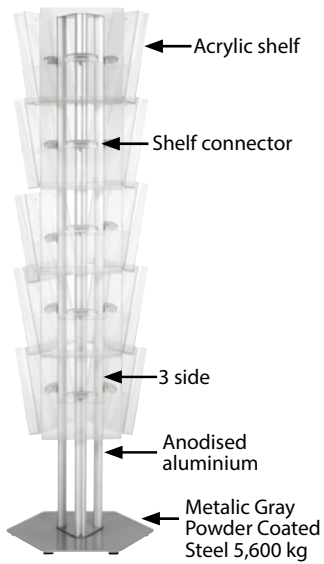

## TECHNICAL DRAWING

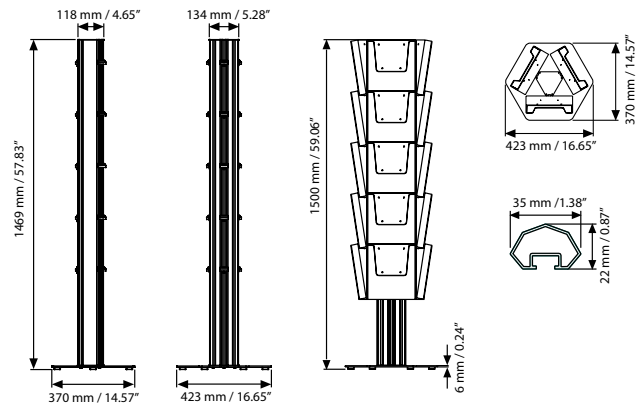

## ARTICLES

ARTICLE	DESCRIPTION	SIZE	WEIGHT	PACKING SIZE
			WITH PACKING	*W X H X D
UMBSG305A4	Main body	5A4	1,890 kg	65 X 1520 X 65 mm
			4,090 kg	340 X 460 X 30 mm
UMBSG305A5	Main body	5A5	1,890 kg	65 X 1520 X 65 mm
			4,090 kg	340 X 460 X 30 mm
UMBSG30523	Main body	5X2A4/3	1,890 kg	65 X 1520 X 65 mm
			4,090 kg	340 X 460 X 30 mm
UMSDA005A4	Acrylic Shelf & Adapter	A4	2,500 kg	180 X 240 X 180 mm (5 Pcs)
UMSDA012A4	Acrylic Shelf & Adapter	A4	6,000 kg	270 X 400 X 270 mm (12 Pcs)
UMSDA000A5	Acrylic Shelf & Adapter	A5	3,200 kg	290 X 360 X 190 mm (12 Pcs)
UMSDA000A43	Acrylic Shelf & Adapter	1/3 A4	2,550 kg	250 X 320 X 180 mm (12 Pcs)
UMSDA02A43	Acrylic Shelf & Adapter	2X1/3 A4	4,350 kg	250 X 320 X 350 mm (12 Pcs)

## OPTIONAL ACCESSORIES



A4 Acrylic shelf with connector.



A5 Acrylic shelf with connector.



1/3 A4 Acrylic shelf with connector.



2 x 1/3 A4 Acrylic shelf with connector.



T: +90 850 433 67 85 / info@mtdisplays.com / www.mtdisplays.com

# PHYSICAL DATA

## Material

Aluminium profile main body, steel base and acrylic shelves.

## Surface Finish

Natural silver-anodized main body, metallic gray RAL 9006 powder coated steel base and transparent shelves in standard. Custom colors also available, call for custom color requests.

## Recycled Content

Up to 100% recycled content used.

## Storage Conditions

Goods should be stored at 0° to 25°C in a dry place. Store in the original package.

## Warranty

All products are guaranteed for 3 years by MT Displays with below conditions:

[Warranty Conditions](#)

## Installation Considerations

Main body of Multiside Brochure Set is packed unassembled in 2 boxes with an easy-to-understand instruction sheet & fixing elements. See info chart for pack sizes. One main body set includes 3 robust poles made from 35x22 mm anodised aluminium profiles with 1500 mm height and channels on each pole, 1 decorative base made from 370x423mm metallic gray RAL 9006 powder coated steel with 6mm thickness and 5,60 kg weight for stability; 4 plastic feet under the base; 15 brochure holder shelf connector (adapter). To complete a product, main body and required quantities of shelves need to be ordered separately. Brochure holders are quickly and easily inserted. Each pole is available to carry 5 brochure holders. Please gently push the shelves over the connectors on the pole. The shelf connectors arrive at fixed positions. For individual adjustment please loosen the screws to move up and down. UMSD008100 and UYUP490000 can be used to form UMSDA005A4 if you have them in your stock. Heavy & stable base for public spaces.

## Design Considerations

Free standing, three sided and decorative brochure holder sets for meeting different needs by utilizing multiple variations of acrylic shelves at low cost. Suitable for INDOOR public spaces with capacity of holding 5 shelves on each pole for A5, A4 and 1/3A4 brochure sizes.

## Cleaning and Disinfecting

Clean your displays, with damp microfiber clothes, rinsed with simply water or warm, soapy or gentle shampooed water. Avoid using vinegar, abrasive, acidic, alcohol-based or heavy cleaners or cleaners containing Ammonia. Only after cleaning the product, if needed, simply apply disinfectant or sanitizer that is in compliance with your local guidelines and regulations.

# INSTALLATION INSTRUCTIONS

## Multiside Brochure Sets 3 Pole / 1004760

Each product includes

- 1 x Main body profile
- 1 x Base
- 15 x Brochure holder adapter
- 3 x Bolt M5x15
- 1 x 5 allen key

Brochure holder excluded. Please ordered separate.

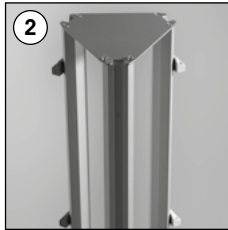
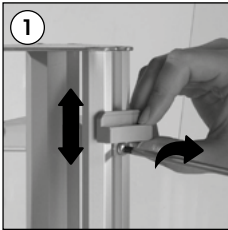
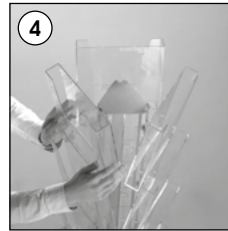
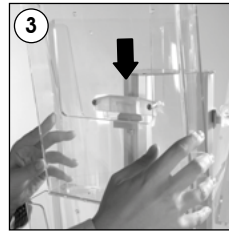
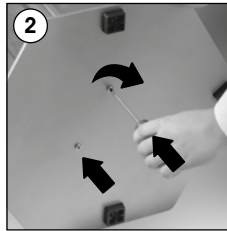
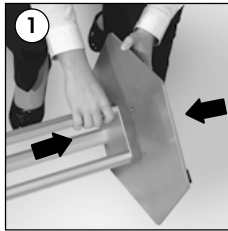

- The shelf connectors over the pole arrives at fixed positions. For person adjustments of up and down, loosen the screws on the connectors.
- Die Halterungen sind auf den Profilen vormontiert. Die Positionen der Halterungen können durch Lösen der Schrauben nach Wunsch geändert werden.
- Raf tutucu aparatlar gövde profili üzerinde ayarlı gelmektedir. Raf tutucu aparatları üzerindeki vidaları gevşeterek istediğiniz konuma getirebilirsiniz.



- Please inform the order number on the product or on the carton (e.g. 1/110001394-460) to the place that you have made the purchase if any problem with the product occurs.
- All rights reserved. All pictures, figures and writings are secured internationally by copy-right law. Infringements will be sued by civil and legal law.

This technical sheet's contents are all subject to update and modification at MT Displays' exclusive discretion. There is nothing official about this document. For final and legally binding information, please get in touch with the sales staff at MT Displays.

