

## MULTISIDE BROCHURE SET ON WHEELS 1 POLE V



### MOVABLE BROCHURE HOLDERS FOR MULTIPLE VARIATIONS OF ACRYLIC SHELVES

Multiside Brochure sets are developed to provide multiple variations at low costs. Based on 1 pole, 3 pole or 4 pole robust aluminium body at height of 1,6 meter, any number of shelves can be fitted to make a brochure set which meets your exact needs. To make a complete product, main body and required quantities of shelves need to be ordered separately. Product is freely rotatable and mobile in all directions over the wheels of the base providing flexibility in brochure presentation.

### KEY SELECTION ATTRIBUTES

- \* Free standing, double sided and decorative brochure holder sets, rotating on a central column mounted on a mobile and stable base for meeting different needs by utilizing multiple variations of acrylic shelves at low cost.
- \* Suitable for INDOOR public spaces with capacity of holding 5 shelves on each sides of the pole for A5, A4, 1/3A4 and 2 x 1/3A4 brochure sizes.
- \* One main body set includes a robust pole made from Ø40 mm anodised aluminium profile with 1600 mm height and channels on each sides, 1 decorative rotating base made from powder coated steel with a stable and moving feet design; 5 wheels for mobility; 10 brochure holder shelf connectors (adapter).
- \* To complete a product, main body and required quantities of shelves need to be ordered separately. Brochure holders are quickly and easily inserted. Each side of the pole is available to carry 5 brochure holders.
- \* Please gently push the shelves over the connectors on the pole. The shelf connectors arrive at fixed positions. For individual adjustment please loosen the screws to move up and down. UMSDA008100 and UYUP490000 can be used to form UMSDA005A4 if you have them in your stock.
- \* Mobile & stable base for public spaces. There are 5 smooth rolling wheels under the base.
- \* Black or natural silver-anodized main body profile, metallic black or gray powder coated steel base and transparent shelf in standard. Custom colors also available, call for custom color requests.
- \* Main body of Multiside Brochure Set is packed unassembled with an easy-to understand instruction sheet & fixing elements. See info chart for pack sizes.



## COLOURS IN STOCK

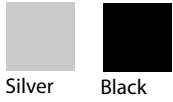

Silver Black

## SUITABLE FOR

Multiside Brochure Sets can be used for INDOOR applications, for displaying brochures in many locations like shopping centers, markets, groceries, hotels, offices airports, shops and stores, hospitals, schools, apartments, restaurants, halls, meeting rooms, gas stations and many more.

## FEATURES



## EXPLODED VIEW

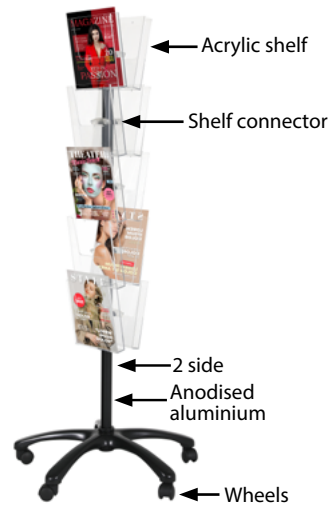

## TECHNICAL DRAWING

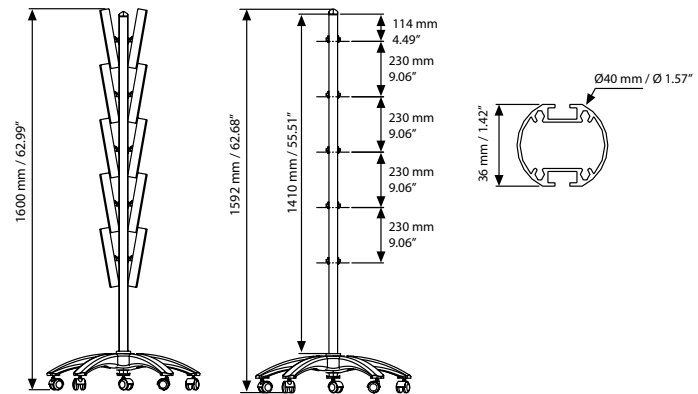

## ARTICLES

ARTICLE	DESCRIPTION	SIZE	WEIGHT	PACKING SIZE
			WITH PACKING	*W X H X D
UMBSG2T5A4	Silver main body	5A4	1,890 kg	700 X 1530 X 70 mm
UMBBG2T5A4	Black main body	5A4	3,000 kg	710 X 720 X 186 mm
UMSDA005A4	Acrylic Shelf & Adapter	A4	2,500 kg	180 X 240 X 180 mm (5 Pcs)
UMSDA012A4	Acrylic Shelf & Adapter	A4	6,000 kg	270 X 400 X 270 mm (12 Pcs)
UMSDA000A5	Acrylic Shelf & Adapter	A5	3,200 kg	290 X 360 X 190 mm (12 Pcs)
UMSDA00A43	Acrylic Shelf & Adapter	1/3 A4	2,550 kg	250 X 320 X 180 mm (12 Pcs)
UMSDA02A43	Acrylic Shelf & Adapter	2X1/3 A4	4,350 kg	250 X 320 X 350 mm (12 Pcs)

## OPTIONAL ACCESSORIES



A4 Acrylic shelf with connector.

A5 Acrylic shelf with connector.

1/3 A4 Acrylic shelf with connector.

2 x 1/3 A4 Acrylic shelf with connector.

## PHYSICAL DATA

### Material

Aluminium profile main body, steel base and acrylic shelves.

### Surface Finish

Black powder coated or natural silver-anodized main body, black or metallic gray RAL 9006 powder coated steel base and transparent shelves in standard. Custom colors also available, call for custom color requests.

### Recycled Content

Up to 78% recycled content used.

### Storage Conditions

Goods should be stored at 0° to 25°C in a dry place. Store in the original package.

### Warranty

All products are guaranteed for 3 years by MT Displays with below conditions:

[Warranty Conditions](#)

### Installation Considerations

Main body of Multiside Brochure Set is packed unassembled with an easy-to-understand instruction sheet & fixing elements. See info chart for pack sizes. One main body set includes a robust pole made from Ø40 mm anodised aluminium profile with 1600 mm height and channels on each sides, 1 decorative rotating base made from powder coated steel with a stable and moving feet design; 5 wheels for mobility; 10 brochure holder shelf connectors (adapter). To complete a product, main body and required quantities of shelves need to be ordered separately. Brochure holders are quickly and easily inserted. Each side of the pole is available to carry 5 brochure holders. Please gently push the shelves over the connectors on the pole. The shelf connectors arrive at fixed positions. For individual adjustment please loosen the screws to move up and down. UMSD008100 and UYUP490000 can be used to form UMSDA005A4 if you have them in your stock. Mobile & stable base for public spaces. There are 5 smooth rolling wheels under the base.

### Design Considerations

Free standing, double sided and decorative brochure holder sets, rotating on a central column mounted on a mobile and stable base for meeting different needs by utilizing multiple variations of acrylic shelves at low cost. Suitable for INDOOR public spaces with capacity of holding 5 shelves on each sides of the pole for A5, A4, 1/3A4 and 2 x 1/3A4 brochure sizes.

### Cleaning and Disinfecting

Clean your displays, with damp microfiber clothes, rinsed with simply water or warm, soapy or gentle shampooed water. Avoid using vinegar, abrasive, acidic, alcohol-based or heavy cleaners or cleaners containing Ammonia. Only after cleaning the product, if needed, simply apply disinfectant or sanitizer that is in compliance with your local guidelines and regulations.



T: +90 850 433 67 85 / [info@mtdisplays.com](mailto:info@mtdisplays.com) / [www.mtdisplays.com](http://www.mtdisplays.com)

# INSTALLATION INSTRUCTIONS

## Multiside Brochure Sets on Wheels 1 Pole / 1007015

### Each product includes

- 1 x Main body profile
- 1 x Base
- 10 x Brochure holder adapter
- 5 x Wheels

Brochure holder excluded.  
Please ordered separate.

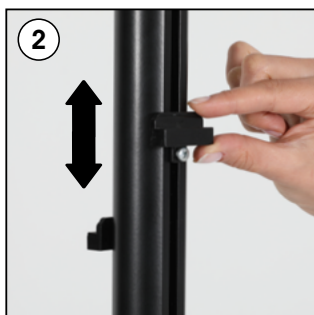
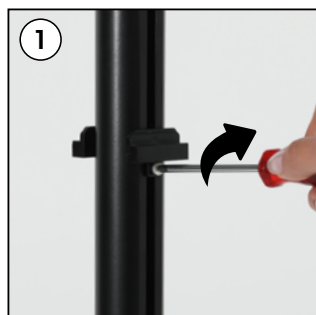
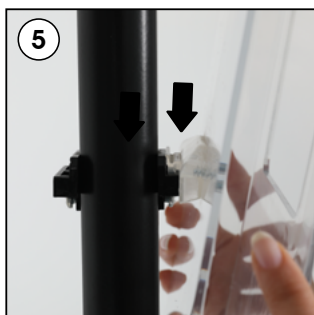
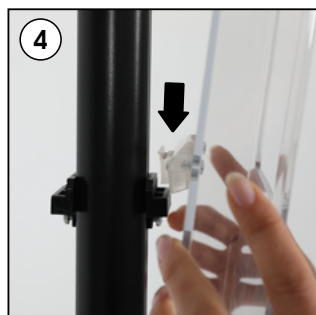
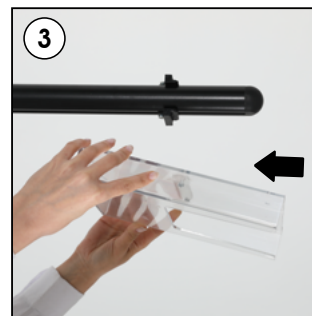
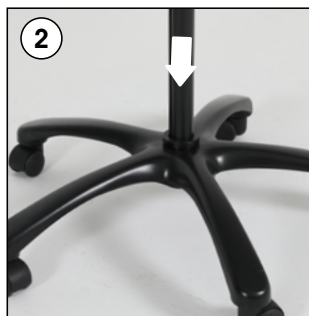

•The shelf connectors over the pole arrives at fixed positions. For person adjustments of up and down, loosen the screws on the connectors.

- Please inform the order number on the product or on the carton (e.g. 1/110001394-460) to the place that you have made the purchase if any problem with the product occurs.
- All rights reserved. All pictures, figures and writings are secured internationally by copy-right law. Infringements will be sued by civil and legal law.

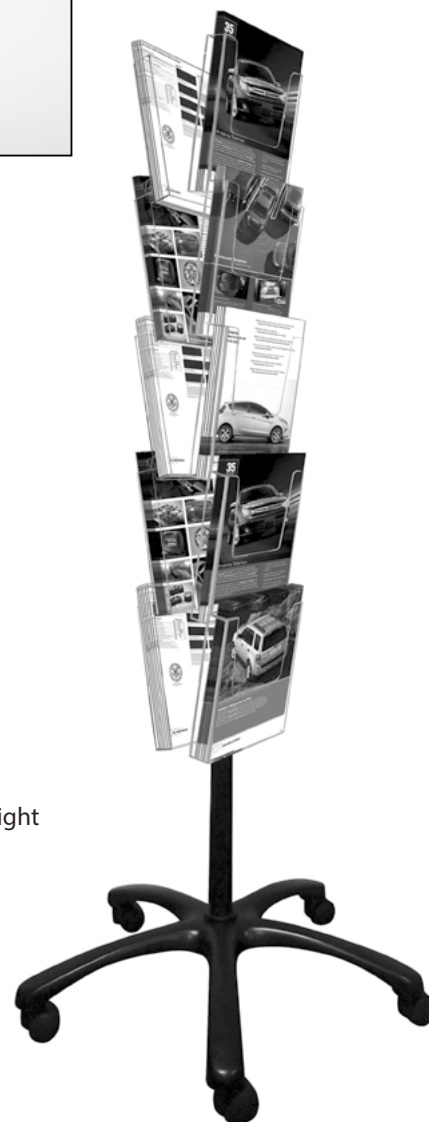

This technical sheet's contents are all subject to update and modification at MT Displays' exclusive discretion. There is nothing official about this document. For final and legally binding information, please get in touch with the sales staff at MT Displays.



T: +90 850 433 67 85 / info@mtdisplays.com / www.mtdisplays.com