

NATURE LINE WRITING BOARD



WALL-MOUNTED BOARDS FOR PRESENTING YOUR MESSAGES AND MORE

Suitable for the display of messages in restaurants, cafés, bars, malls, offices and education centers. The erasable surface enables you to erase your messages and transmit them to your audience while keeping them updated. You can use a chalkboard pen to write on the black surface. There are also special water-based and scent-free markers. We sell chalk pens individually 2 in convenient sets.

KEY SELECTION ATTRIBUTES

- * Practical and wall-mounted Beech Wood Chalk Frame with shelf design.
- * Suitable for wall mounting with Natural Wood and Dark Wood options.
- * Perfect way to present/change messages, announcements or promotions.
- * One set includes beech wood frame and shelf with lacquered finish for durability, a magnetic chalkboard for changing notes easily, 2 hangers and 2 screws for installing on wall, and 4 magnetic buttons. If additional magnetic buttons needed, please order separately.
- * Optional accessories like chalkboard pens are not included. Please order

separately.

- * For spotless removing of chalk pens from surface, please use window & glass cleaner, otherwise clean with damp cloth.
- * Packed in a box with mounting set and easy-to-understand installation sheet.



Natural Wood



Dark Wood



COLOURS IN STOCK



Natural Wood

Dark Wood

SUITABLE FOR

Nature Line Writing Boards can be used for INDOOR applications, for signage needs in many locations like shopping centers, markets, groceries, hotels, offices airports, shops and stores, hospitals, schools, apartments and many more.

FEATURES



EXPLODED VIEW

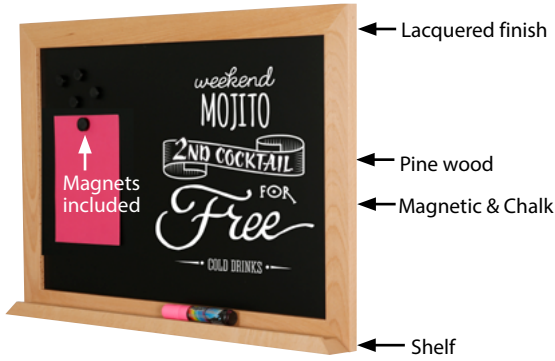

TECHNICAL DRAWING

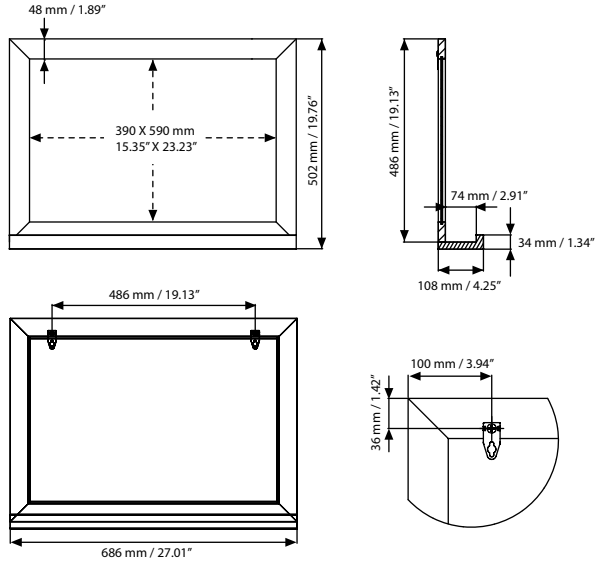

ARTICLES

ARTICLE	PANEL SIZE	DESCRIPTION	WEIGHT	PACKING SIZE
			WITH PACKING	*W X H X D
UWNLWONOF2	400 X 600 mm	Natural Wood - Black Chalkboard	2,280 kg	570 X 730 X 45 mm
UWNLWODOF2	400 X 600 mm	Dark Wood - Black Chalkboard	2,280 kg	570 X 730 X 45 mm

OPTIONAL ACCESSORIES



Optional magnetic buttons. Packed in 10. UYUP397000



Colour chalkboard marker. 10 mm wide. 5 Pcs. / UYAKLM1251



White chalkboard marker for Wood Display. 10 mm wide. 3 Pcs / UYAKLM1250

PHYSICAL DATA

Material

Beech Wood frame, magnetic chalkboard.

Surface Finish

Beech Wood frame with Natural Wood and Dark Wood options and lacquered finish, black colored chalkboard.

Storage Conditions

Goods should be stored at 0° to 25°C in a dry place. Store in the original package.

Warranty

All products are guaranteed for 1 years by MT Displays with below conditions:

[Warranty Conditions](#)

Storage Conditions

Goods should be stored at 0° to 25°C in a dry place. Store in the original package.

Installation Considerations

Packed in a box with mounting set and easy-to-understand installation sheet. One set includes

beech wood frame and shelf with lacquered finish for durability, a magnetic chalkboard for changing notes easily, 2 hangers and 2 screws for installing on wall, and 4 magnetic buttons. If additional magnetic buttons needed, please order separately. Optional accessories like chalkboard pens are not included. Please order separately.

Design Considerations

Practical and wall-mounted Beech Wood Chalk Frame with shelf design. Suitable for wall mounting with Natural Wood and Dark Wood options. Perfect way to present/change messages, announcements or promotions. For spotless removing of chalk pens from surface, please use window & glass cleaner, otherwise clean with damp cloth.

Cleaning and Disinfecting

Clean your displays, with damp microfiber clothes, rinsed with simply water or warm, soapy or gentle shampooed water. Avoid using vinegar, abrasive, acidic, alcohol-based or heavy cleaners or cleaners containing Ammonia. Only after cleaning the

product, if needed, simply apply disinfectant or sanitizer that is in compliance with your local guidelines and regulations.



T: +90 850 433 67 85 / info@mtdisplays.com / www.mtdisplays.com

INSTALLATION INSTRUCTIONS

Nature Line Writing Board / 1012699H000

Each product includes

- 2 x Hanger
- 2 x Screw
- 4 x Magnetic buttons

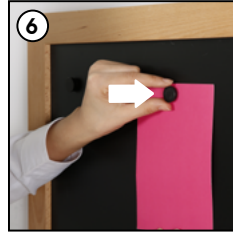
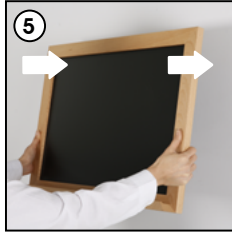
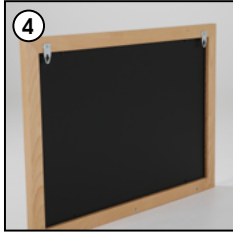
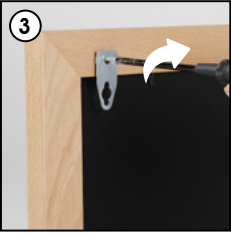
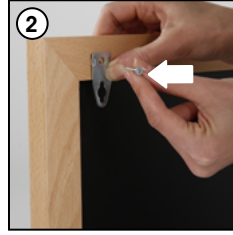
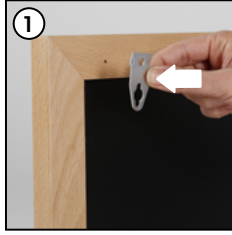
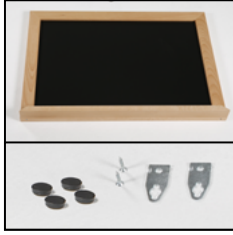

Chalkboard Markers are not included in pack.

- Please inform the order number on the product or on the carton (e.g. 1/110001394-460) to the place that you have made the purchase if any problem with the product occurs.
- All rights reserved. All pictures, figures and writings are secured internationally by copy-right law. Infringements will be sued by civil and legal law.

This technical sheet's contents are all subject to update and modification at MT Displays' exclusive discretion. There is nothing official about this document. For final and legally binding information, please get in touch with the sales staff at MT Displays.



T: +90 850 433 67 85 / info@mtdisplays.com / www.mtdisplays.com