

NEWAGE POSTER CLAMP



HIGH QUALITY POSTER RAILS FOR EFFORTLESSLY HANGING AD SIGNS

A newly created series of poster clamps offers competitive solutions. The aluminium poster rail is a low-cost banner grip for various applications. They are used as sign hangers and high quality poster rails that represent posters with minimal effort and visibility. These poster clamp hanging rails have bottom and top rails, 2 rails on a set to hold posters in between. One set comes with profiles, end caps and hangers. The banner rails are made of aluminium and the profiles are easy to open with your fingers and no tools are required. The Banner Grip models are available in a variety of sizes and are suitable for all hanging poster requirements. Posters are held high in the rails and do not fall off. These indoor hanging sign holders are less expensive compared to conventional snap frames. These inexpensive rails are usually used in front of shop windows with suction cups or clear strings. It's suitable for silk screen printing.

KEY SELECTION ATTRIBUTES

- Ideal for various sizes of posters.
- Silver anodised aluminium in standard.
- One set includes profiles, end caps and hangers.
- Easy to assemble without tool.
- Suitable for posters in thickness 50 micron / 500 micron.
- Suitable for silk screen printing.



COLOURS IN STOCK COLOUR OPTIONS

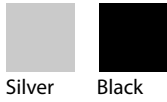

Silver Black

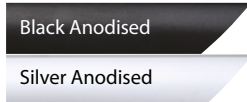

Black Anodised Silver Anodised

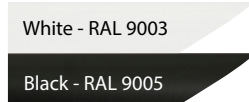

White - RAL 9003 Black - RAL 9005

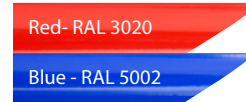

Red - RAL 3020 Blue - RAL 5002



Green - RAL 6029 Yellow - RAL 1021

SUITABLE FOR

Snap Frame can be used for INDOOR applications, for signage needs in many locations like shopping centers, markets, groceries, hotels, offices airports, shops and stores, hospitals, schools, apartments and many more.

WATCH VIDEO



Watch video at our website www.mtdisplays.com

FEATURES



EXPLODED VIEW

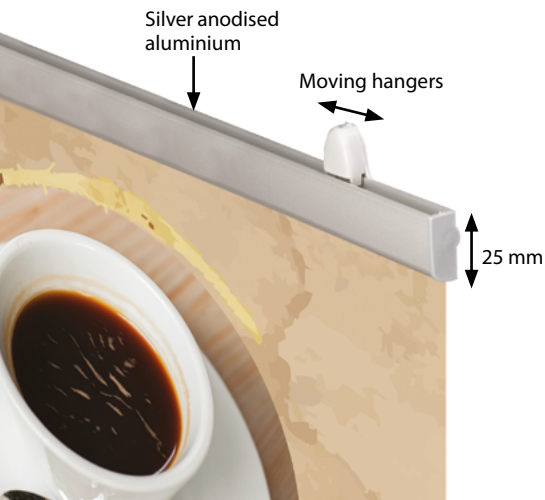

TECHNICAL DRAWING

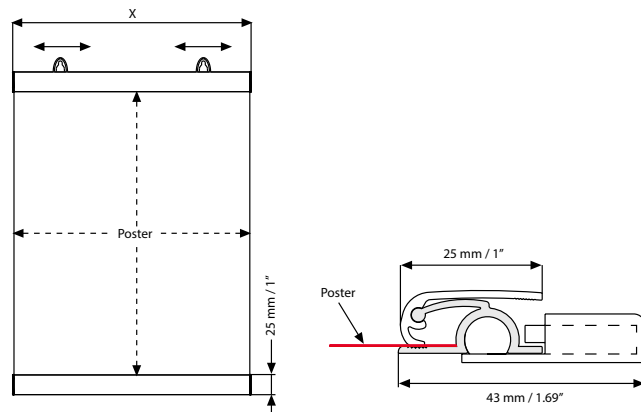

ARTICLES

ARTICLE	EXTERNAL (x)	POSTER	WEIGHT	PACKING SIZE
			WITH PACKING	*W X H X D
UPCO0SN021	216 mm	210 mm	9,570 kg	220 X 260 X 320 mm (50 pcs)
UPCO0SN030	306 mm	300 mm	12,000 kg	220 X 360 X 320 mm (50 pcs)
UPCO0SN042	426 mm	420 mm	18,500 kg	220 X 480 X 320 mm (50 pcs)
UPCO0SN050	506 mm	500 mm	22,200 kg	220 X 560 X 320 mm (50 pcs)
UPCO0SN060	606 mm	600 mm	26,600 kg	220 X 660 X 320 mm (50 pcs)
UPCO0SN070	706 mm	700 mm	31,000 kg	220 X 760 X 320 mm (50 pcs)
UPCO0SN085	856 mm	850 mm	19,000 kg	180 X 910 X 220 mm (25 pcs)
UPCO0SN100	1006 mm	1000 mm	22,000 kg	180 X 1070 X 220 mm (25 pcs)
UPCO0SN610	24.25"	24"	0.903 lbs	2.36" X 25.98" X 1.77"
UPCO0SN762	30.24"	30"	1.124 lbs	2.36" X 32.28" X 1.77"
UPCO0SN915	36.26"	36"	1.366 lbs	2.36" X 37.80" X 1.77"
UPCO0SN122	48.27"	48"	1.807 lbs	2.36" X 74.41" X 1.77"
UPCO0SN183	72.24"	72"	2.711 lbs	2.36" X 50.39" X 1.77"

PHYSICAL DATA

Material

25mm silver anodised aluminium profile.

Poster Material & Thickness

Suitable for posters in thickness 50 micron / 500 micron for standard product. Any non-standard poster thicknesses should be indicated with order.

Surface Finish

Silver anodized or black colour, antimicrobial powder coating. Custom colors also available, call for custom color requests.

Recycled Content

Up to 78% recycled content used.

Warranty

All products are guaranteed for 3 years by MT Displays with below conditions: [Warranty Conditions](#)

Storage Conditions

Goods should be stored at 0° to 25°C in a dry place. Store in the original package.

Installation Considerations

In top clamp 10 mm poster and in bottom clamp 10 mm poster is placed within the clamping system. Single packed as set in plastic bags. Turning end caps help to slide the poster in. No tool assembly. Hangers are suitable for wall mounting and ceiling suspension. Moving hangers allow easy assembly.

Design Considerations

Product is not recommended for use in special sizes wider than 1000 mm and longer then 2000 mm. Suitable for silk screen printing, max. letter height is 15 mm.

Cleaning and Disinfecting

Clean your displays, with damp microfiber clothes, rinsed with simply water or warm, soapy or gentle shampooed water. Avoid using vinegar, abrasive, acidic, alcohol-based or heavy cleaners or cleaners containing Ammonia. Only after cleaning the product, if needed, simply apply disinfectant or sanitizer that is in compliance with your local guidelines and regulations.



T: +90 850 433 67 85 / info@mtdisplays.com / www.mtdisplays.com

PRINT TEMPLATES

Poster Clamp - 210 mm

Document Size: 220 mm (Includes Bleeds)
Finished Size: 210 mm [Print](#)

Poster Clamp - 300 mm

Document Size: 310 mm (Includes Bleeds)
Finished Size: 300 mm [Print](#)

Poster Clamp - 420 mm

Document Size: 430 mm (Includes Bleeds)
Finished Size: 420 mm [Print](#)

Poster Clamp - 500 mm

Document Size: 510 mm (Includes Bleeds)
Finished Size: 500 mm [Print](#)

Poster Clamp - 600 mm

Document Size: 610 mm (Includes Bleeds)
Finished Size: 600 mm [Print](#)

Poster Clamp - 700 mm

Document Size: 710 mm (Includes Bleeds)
Finished Size: 700 mm [Print](#)

Poster Clamp - 850 mm

Document Size: 860 mm (Includes Bleeds)
Finished Size: 850 mm [Print](#)

Poster Clamp - 1000 mm

Document Size: 1010 mm (Includes Bleeds)
Finished Size: 1000 mm [Print](#)

Poster Clamp - 24"

Document Size: 24.4" (Includes Bleeds)
Finished Size: 24" (609.6 mm)

Poster Clamp - 30"

Document Size: 30.4" (Includes Bleeds)
Finished Size: 30" (762 mm)

Poster Clamp - 36"

Document Size: 36.4" (Includes Bleeds)
Finished Size: 36" (914.4 mm)

Poster Clamp - 48"

Document Size: 48.4" (Includes Bleeds)
Finished Size: 48" (1219 mm)

Poster Clamp - 72"

Document Size: 72.4" (Includes Bleeds)
Finished Size: 72" (1828 mm)

INSTALLATION INSTRUCTIONS

Newage Poster Clamp / 1001990

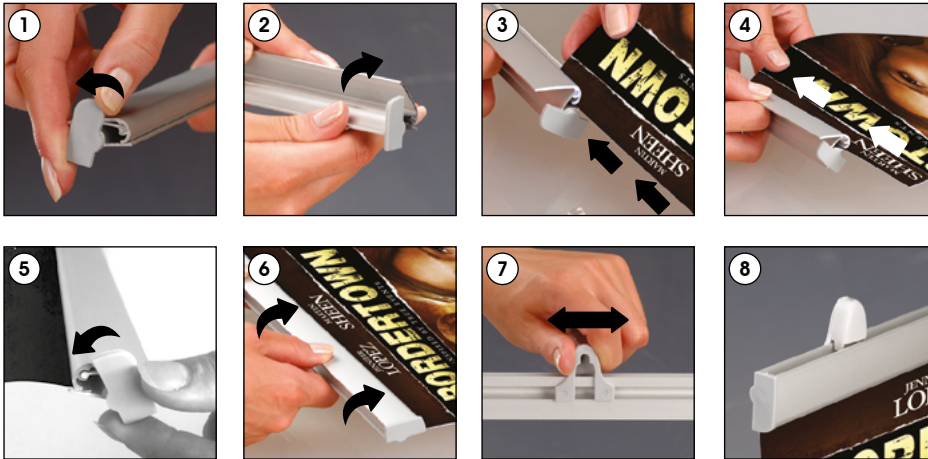

Moving Hangers

Each pack includes 2 hanger



- Please inform the order number on the product or on the carton (e.g. 1/110001394-460) to the place that you have made the purchase if any problem with the product occurs.
- All rights reserved. All pictures, figures and writings are secured internationally by copy-right law. Infringements will be sued by civil and legal law.

This technical sheet's contents are all subject to update and modification at MT Displays' exclusive discretion. There is nothing official about this document. For final and legally binding information, please get in touch with the sales staff at MT Displays.



T: +90 850 433 67 85 / info@mtdisplays.com / www.mtdisplays.com