

NOVEL FREE STANDING LEAFLET DISPLAY



MULTIPLE VARIATIONS OF POSTER DISPLAYS AND BROCHURE HOLDERS

New to our range, this robust, silver anodised Novel Free Standing brochure and sign system allows designing various styles to suit different environment. 4-channel profile holds accessories to make single sided or double sided display system.

KEY SELECTION ATTRIBUTES

- * Free standing, four sided, new range brochure stands for meeting different needs by utilizing multiple variations of display models at low cost.
- * Suitable for INDOOR public spaces with capacity of holding banners, single-sided or double -sided frames and shelves separately or collectively on four sides of the main pole for various poster & brochure sizes.
- * One main body set includes a robust pole made from 70x30 mm anodised aluminium profile with 1920 mm height and 4 slide-in channels on both sides, a heavy decorative base made from Ø450 metallic gray RAL 9006 powder coated steel with 6 mm thickness for stability, bolts and allen key for installation.
- * To complete a product, main body and required quantities of banners, poster frames and/or brochure holder shelves need to be ordered separately.
- * Snap or Slide-in poster frames, banners, brochure holders and shelves with special codes are packed with fixing elements for sliding in the channels of four sides of the pole and fixing at desired height.

- * Snap frames with 25mm profiles are recommended for use in portrait and landscape positions. Powder coated steel shelves with 1,2 mm thickness, clear acrylic shelves with 4 mm thickness, Ø250 mm circle and 250x250 mm square shaped MDF shelves are available as optional accessories.
- * Optional acrylic logo header with 3mm thickness, is not included in original pack, should be ordered separately.
- * Make up your own stand in your desired variation. Heavy & stable base for public spaces.
- * Natural silver-anodized main body profile and poster frames, metallic gray powder coated steel base, powder coated shelves, transparent shelves and headers in standard. Custom colors also available, call for custom color requests.
- * Main body of Free Standing Leaflet Displays is packed unassembled in 2 boxes with an easy-to understand instruction sheet & fixing elements. See info chart for pack sizes. Assembled in 40 seconds.



COLOURS IN STOCK



Silver

COLOUR OPTIONS

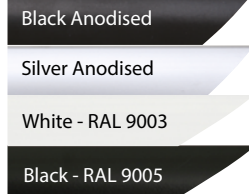

SUITABLE FOR

Novel Free Standing Leaflet Display can be used for INDOOR applications, for signage needs in many locations like shopping centers, markets, groceries, hotels, offices airports, shops and stores, hospitals, schools, apartments, restaurants, halls, meeting rooms, gas stations and many more.

WATCH VIDEO



Watch video at our website
www.mtdisplays.com

FEATURES

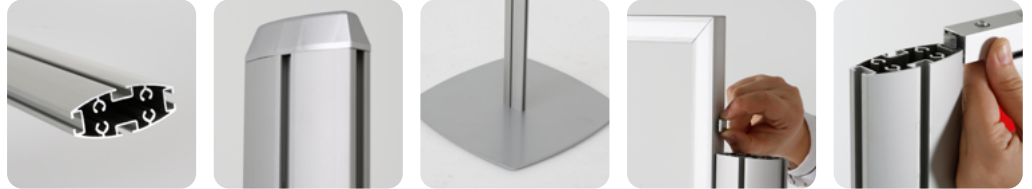

EXPLODED VIEW

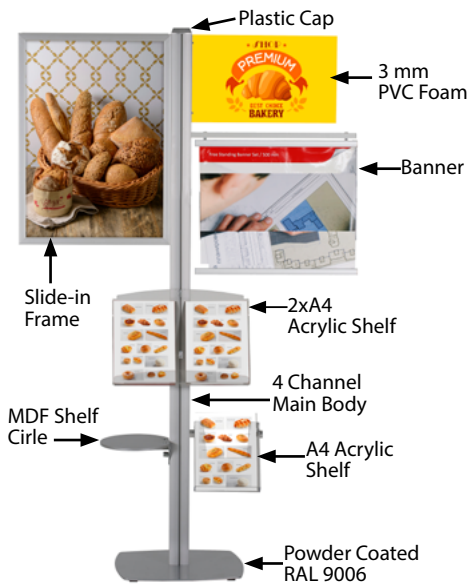

TECHNICAL DRAWING

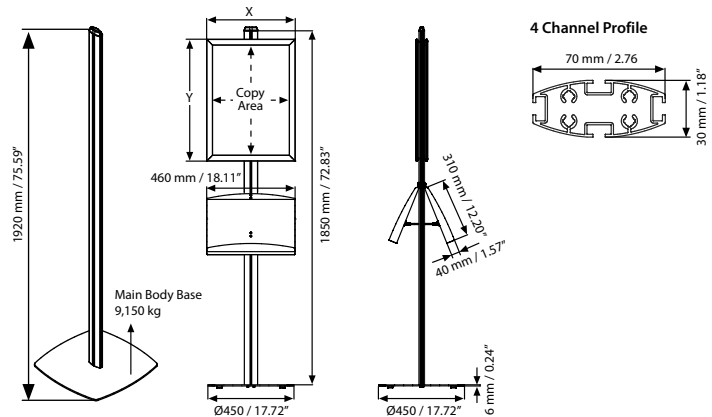

Some possible variations using Novel 4 channel profile

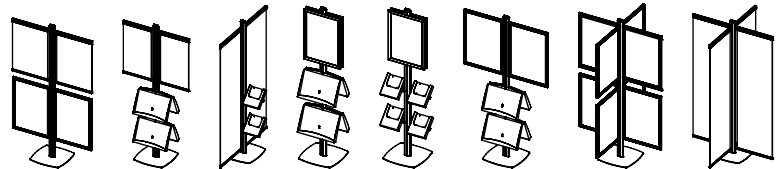

ARTICLES

MAINBODY WITH 4 CHANNEL: Powder coated in RAL 9006			
ARTICLE	DESCRIPTION	WEIGHT WITH PACKING	PACKING SIZE *W X H X D
UFSL001200	Main body pole	2,450 kg	90 X 1930 X 45 mm
	Main body base	9,150 kg	480 X 480 X 45 mm

OPTIONAL ACCESSORIES

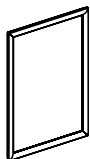

SNAP FRAME: 25 mm 45° - 25 mm round					WEIGHT	PACKING SIZE
MITRED ARTICLE	ROUND ARTICLE	EXTERNAL (x-y)	POSTER	COPY	WITH PACKING	*W X H X D
UFSL0000A2	UFSL0100A2	463 X 637 mm	420 X 594 mm	401 X 575 mm	1,230 kg	460 X 660 X 21 mm
UFSL0000A1	UFSL0100A1	637 X 884 mm	594 X 841 mm	575 X 822 mm	2,245 kg	650 X 900 X 21 mm
UFSL0000B2	UFSL0100B2	543 X 743 mm	500 X 700 mm	481 X 681 mm	1,600 kg	550 X 750 X 21 mm
UFSL0000B1	UFSL0100B1	743 X 1043 mm	700 X 1000 mm	681 X 981 mm	2,970 kg	750 X 1050 X 21 mm
UFSL000081	UFSL010081	9.69" X 12.17"	8.5" X 11"	7.80" X 10.28"	1.102 lbs	10.63" X 12.20" X 0.83"
UFSL000017	UFSL010017	12.17" X 18.19"	11" X 17"	10.28" X 16.30"	1.873 lbs	12.99" X 18.90" X 0.83"
UFSL000014	UFSL010014	15.20" X 23.19"	14" X 22"	13.31" X 21.30"	2.711 lbs	16.54" X 24.41" X 0.83"
UFSL000018	UFSL010018	19.21" X 25.50"	18" X 24"	17.32" X 23.31"	2.645 lbs	20.08" X 25.98" X 0.83"
UFSL000022	UFSL010022	23.19" X 29.17"	22" X 28"	21.30" X 27.28"	3.637 lbs	24.02" X 30.31" X 0.83"



BANNER			WEIGHT	PACKING SIZE (20 Pcs)
ARTICLE	EXTERNAL (x)	POSTER	WITH PACKING	*W X H X D
UFSL110000	400 mm	400 mm	6,000 kg	230 X 460 X 120 mm
UFSL110100	500 mm	500 mm	7,200 kg	230 X 560 X 120 mm
UFSL110200	600 mm	600 mm	8,600 kg	230 X 660 X 120 mm
UFSL110300	700 mm	700 mm	10,000 kg	230 X 760 X 120 mm
UFSL110011	11"	11"	11.904 lbs	9.06" X 13.39" X 5.51"
UFSL110014	14"	14"	12.897 lbs	17.32" X 9.06" X 5.51"
UFSL110018	18"	18"	17.504 lbs	9.06" X 21.26" X 5.51"
UFSL110022	22"	22"	20.282 lbs	9.06" X 25.20" X 5.51"



T: +90 850 433 67 85 / info@mtdisplays.com / www.mtdisplays.com

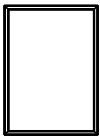

SLIDE-IN FRAME				WEIGHT WITH PACKING	PACKING SIZE *W X H X D
ARTICLE	EXTERNAL (x-y)	POSTER	COPY		
UFSL130300	233 X 320 mm	210 X 297 mm	183 X 270 mm	0,825 kg	240 X 330 X 25 mm
UFSL130200	320 X 443 mm	297 X 420 mm	270 X 393 mm	1,200 kg	330 X 450 X 25 mm
UFSL130100	443 X 617 mm	420 X 594 mm	393 X 567 mm	1,820 kg	450 X 630 X 25 mm
UFSL130500	531 X 785 mm	508 X 762 mm	481 X 735 mm	2,700 kg	540 X 800 X 25 mm
UFSL130400	523 X 723 mm	500 X 700 mm	437 X 673 mm	2,800 kg	540 X 733 X 25 mm
UFSL130081	9.41" X 11.91"	8.5" X 11"	7.44" X 9.94"	1.7 lbs	9.4" X 13" X 1"
UFSL130017	11.91" X 17.91"	11" X 17"	9.94" X 15.94"	2.6 lbs	13" X 17.7" X 1"
UFSL130014	14.91" X 22.91"	14" X 22"	12.94" X 20.94"	4 lbs	17.7" X 24.8" X 1"
UFSL130018	18.91" X 24.91"	18" X 24"	16.94" X 22.94"	6 lbs	21.2" X 31.5" X 1"
UFSL130700	22.91" X 28.91"	22" X 28"	20.94" X 26.94"	6.2lbs	21.2" X 28.8" X 1"

Shelf options: 1. model

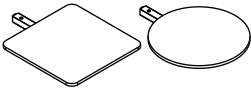

SHELF OPTIONS 1: 8 mm MDF				WEIGHT WITH PACKING	PACKING SIZE *W X H X D
ARTICLE	MODEL	SIZE	WEIGHT CAPACITY		
UFSL002500	Circle	Ø 250 mm	max. 1 kg	0,610 kg	260 X 350 X 35 mm
UFSL002510	Square	250 x 250 mm	max. 1 kg	0,705 kg	260 X 350 X 35 mm

Shelf options: 2. model

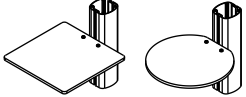

SHELF OPTIONS 2: 8 mm MDF				WEIGHT WITH PACKING	PACKING SIZE *W X H X D
ARTICLE	MODEL	SIZE	WEIGHT CAPACITY		
UFSL002550	Circle	Ø 250 mm	max. 5 kg	0,830 kg	270 X 285 X 105 mm
UFSL002560	Square	250 x 250 mm	max. 5 kg	1,010 kg	270 X 285 X 105 mm



LEAFLET DISPENSERS : Clear Acrylic			WEIGHT WITH PACKING	PACKING SIZE *W X H X D
ARTICLE	DESCRIPTION	SIZE		
UFSL120000	Acrylic Shelf	A4	0,410 kg	270 X 245 X 55 mm



SIDE SHELF : Clear Acrylic			WEIGHT WITH PACKING	PACKING SIZE *W X H X D
ARTICLE	DESCRIPTION	SIZE		
UFSL140000	Acrylic Shelf	A4	0,830 kg	270 X 245 X 55 mm
UFSL140100	Acrylic Shelf	A5	0,510 kg	245 X 195 X 55 mm
UFSL140200	Acrylic Shelf	1/3 A4	0,335 kg	195 X 150 X 55 mm

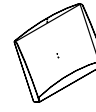

STEEL & ACRYLIC SHELF		WEIGHT WITH PACKING	PACKING SIZE *W X H X D
ARTICLE	CAPACITY		
UFSL002000	2 X A4 steel shelf	1,800 kg	360 X 470 X 60 mm
UFSL003000	2 X A4 acrylic shelf	1,400 kg	360 X 470 X 60 mm



MATERIAL : Opaque acrylic			WEIGHT WITH PACKING	PACKING SIZE *W X H X D
ARTICLE	DESCRIPTION	SIZE		
UFSL120100	Header	350 X 160 mm	0,300 kg	195 X 365 X 22 mm
UFSL120200	Header	450 X 160 mm	0,300 kg	175 X 465 X 55 mm

PHYSICAL DATA

Material

70x30mm aluminium profile main body, Ø450mm steel base, 25mm aluminium profile frames, steel shelves, MDF shelves, acrylic shelves and acrylic headers.

Surface Finish

Natural silver-anodized aluminium main body profile, metallic gray RAL 9006 powder coated steel base, natural silver-anodized profile frames, powder coated steel and MDF shelves, transparent acrylic shelves and headers in standard. Custom colors also available, call for custom color requests.

Recycled Content

85% recycled content used.

Storage Conditions

Goods should be stored at 0° to 25°C in a dry place. Store in the original package.

Warranty

2 years warranted by MT Displays. See conditions: [Warranty Conditions](#)

Installation Considerations

Main body of Free Standing Leaflet Displays is packed unassembled in 2 boxes with an easy-to-understand instruction sheet & fixing elements. See info chart for pack sizes. Assembled in 40 seconds. One main body set includes a robust pole made from 70x30 mm anodised aluminium profile with 1920 mm height and 4 slide-in channels on both sides, a heavy decorative base made from Ø450 metallic gray RAL 9006 powder coated steel with 6 mm thickness for stability, bolts and allen key for installation. To complete a product, main body and required quantities of banners, poster frames and/or brochure holder shelves need to be ordered separately. Snap or Slide-in poster frames, banners, brochure holders and shelves with special codes are packed with fixing elements for sliding in the channels of four sides of the pole and fixing at desired height. Snap frames with 25mm profiles are recommended for use in portrait and landscape positions. Powder coated steel shelves with 1,2 mm thickness, clear acrylic shelves with 4 mm thickness, Ø250 mm circle and 250x250 mm square shaped MDF shelves are available as optional accessories. Optional acrylic logo header

with 3mm thickness, is not included in original pack, should be ordered separately. Make up your own stand in your desired variation. Heavy & stable base for public spaces.

Design Considerations

Free standing, four sided, new range brochure stands for meeting different needs by utilizing multiple variations of display models at low cost. Suitable for INDOOR public spaces with capacity of holding banners, single-sided or double-sided frames and shelves separately or collectively on four sides of the main pole for various poster & brochure sizes.

Cleaning and Disinfecting

Clean your displays, with damp microfiber clothes, rinsed with simply water or warm, soapy or gentle shampooed water. Avoid using vinegar, abrasive, acidic, alcohol-based or heavy cleaners or cleaners containing Ammonia. Only after cleaning the product, if needed, simply apply disinfectant or sanitizer that is in compliance with your local guidelines and regulations.



INSTALLATION INSTRUCTIONS

Novel Free Standing Main Body / 1010495H000

Each product includes

- 1 x Base
- 1 x Main body profile (4 channel)
- 1 x 5 allen key
- 4 x Bolt M6x30

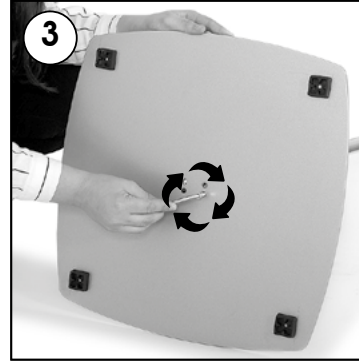
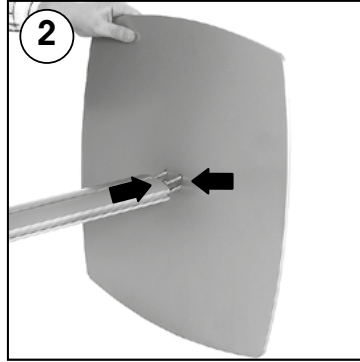
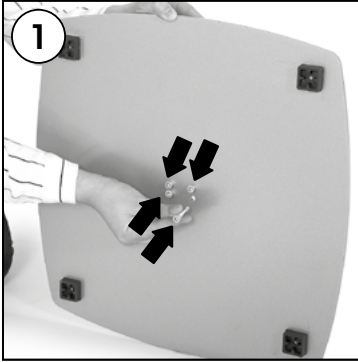

- Please inform the order number on the product or on the carton (e.g. 1/110001394-460) to the place that you have made the purchase if any problem with the product occurs.
- All rights reserved. All pictures, figures and writings are secured internationally by copy-right law. Infringements will be sued by civil and legal law.

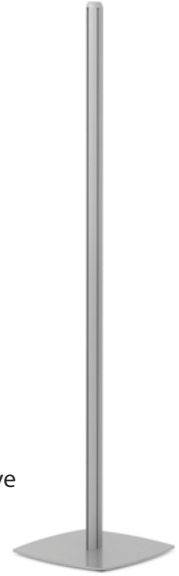

This technical sheet's contents are all subject to update and modification at MT Displays' exclusive discretion. There is nothing official about this document. For final and legally binding information, please get in touch with the sales staff at MT Displays.



T: +90 850 433 67 85 / info@mtdisplays.com / www.mtdisplays.com