

## PILLAR BROCHURE STAND



### OUTDOOR FRIENDLY BROCHURE HOLDERS WITH ACRYLIC TOP SHELF

New selection of literature display including injected counter top with a robust aluminum body. 3xA4 capacity and 6x1/3A4 capacity standards are available.

#### KEY SELECTION ATTRIBUTES

- \* Free standing, OUTDOOR FRIENDLY and decorative brochure holders with an acrylic top shelf.
- \* Suitable for public spaces with two shelf versions for holding 3xA4 and 6x1/3A4 brochure sizes.
- \* One set includes an acrylic transparent shelf suitable for holding 3xA4 brochures or 2 acrylic transparent shelves suitable for holding 6x1/3A4 brochures, 50x35 mm anodised aluminium main body profile with 1200 mm height for 3xA4 version and 1100mm height for 6x1/3A4 version, 330x250 mm

- metallic gray RAL 9006 powder coated decorative base with 2,70 kg weight for stability, 1 brochure holder shelf connector, bolts, nuts and 1 allen key for fixing.
- \* Heavy stable base for public spaces.
- \* Natural silver-anodized main body profile, metallic gray powder coated steel base and transparent shelf in standard. Custom colors also available, call for custom color requests.
- \* Pillar brochure stand is packed unassembled in 2 boxes with an easy-to-understand instruction sheet & fixing elements. See info chart for pack sizes.

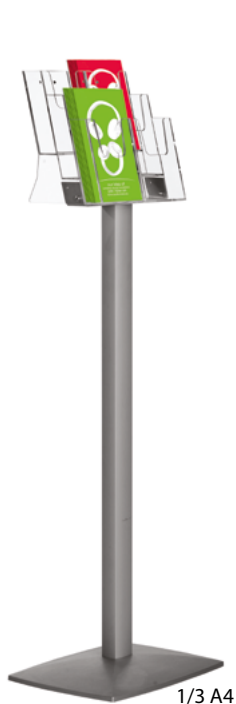

## COLOURS IN STOCK



Silver

## SUITABLE FOR

Pillar Brochure Stands are OUTDOOR FRIENDLY, they can be used for displaying brochures in many locations like shopping centers, markets, groceries, hotels, offices airports, shops and stores, hospitals, schools, apartments, restaurants, halls, meeting rooms, gas stations and many more.

## FEATURES

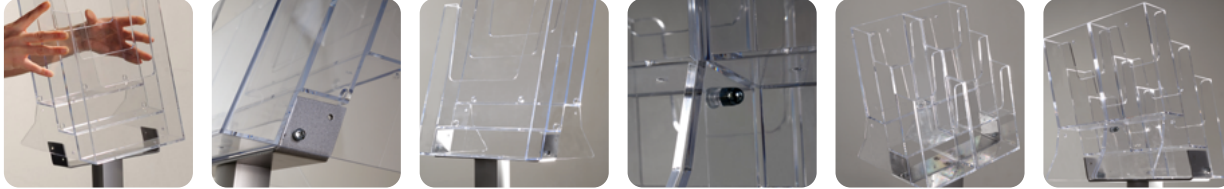

## EXPLODED VIEW

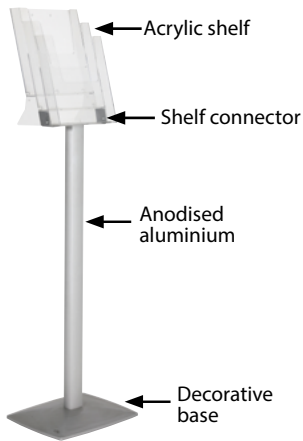

## TECHNICAL DRAWING

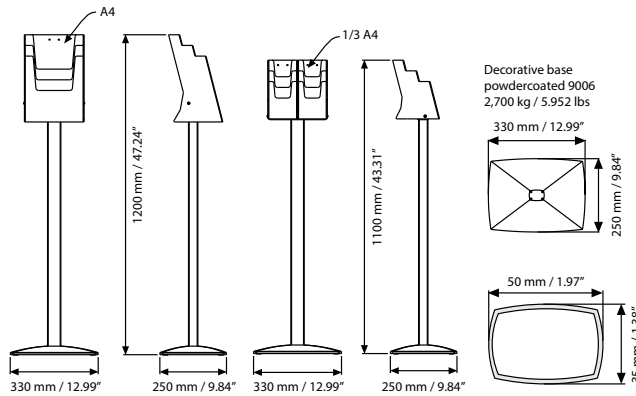

## ARTICLES

ARTICLE	SIZE	WEIGHT	PACKING SIZE
		WITH PACKING	*W X H X D
UPBS3000A4	A4	4,230 kg	270 X 420 X 190 mm
		0,820 kg	70 X 870 X 45 mm
UPBS3004A3	1/3 A4	4,070 kg	270 X 520 X 190 mm
		0,820 kg	70 X 870 X 45 mm

## PHYSICAL DATA

### Material

Aluminium profile main body, steel base and acrylic shelf.

### Surface Finish

Natural silver-anodized main body, metallic gray RAL 9006 powder coated steel base and transparent shelf in standard. Custom colors also available, call for custom color requests.

### Storage Conditions

Goods should be stored at 0° to 25°C in a dry place. Store in the original package.

### Recycled Content

Up to 78% recycled content used.

### Warranty

All products are guaranteed for 3 years by MT Displays with below conditions:  
[Warranty Conditions](#)

### Installation Considerations

Pillar brochure stand is packed unassembled in 2 boxes with an easy-to-understand instruction sheet & fixing elements. See info chart for pack sizes. One set includes an acrylic transparent shelf suitable for holding 3xA4 brochures or 2 acrylic transparent shelves suitable for holding 6x1/3A4 brochures, 50x35 mm anodised aluminium main body profile with 1200 mm height for 3xA4 version and 1100mm height for 6x1/3A4 version, 330x250 mm metallic gray RAL 9006 powder coated decorative base with 2,70 kg weight for stability, 1 brochure holder shelf connector, bolts, nuts and 1 allen key for fixing. Heavy stable base for public spaces.

### Design Considerations

Free standing, OUTDOOR FRIENDLY, decorative brochure holders with an acrylic top shelf. Suitable for public spaces with two shelf versions for holding 3xA4 and 6x1/3A4 brochure sizes.

### Cleaning and Disinfecting

Clean your displays, with damp microfiber clothes, rinsed with simply water or warm, soapy or gentle shampooed water. Avoid using vinegar, abrasive, acidic, alcohol-based or heavy cleaners or cleaners containing Ammonia. Only after cleaning the product, if needed, simply apply disinfectant or sanitizer that is in compliance with your local guidelines and regulations.



T: +90 850 433 67 85 / [info@mtdisplays.com](mailto:info@mtdisplays.com) / [www.mtdisplays.com](http://www.mtdisplays.com)

# INSTALLATION INSTRUCTIONS

## Pillar Brochure Stands

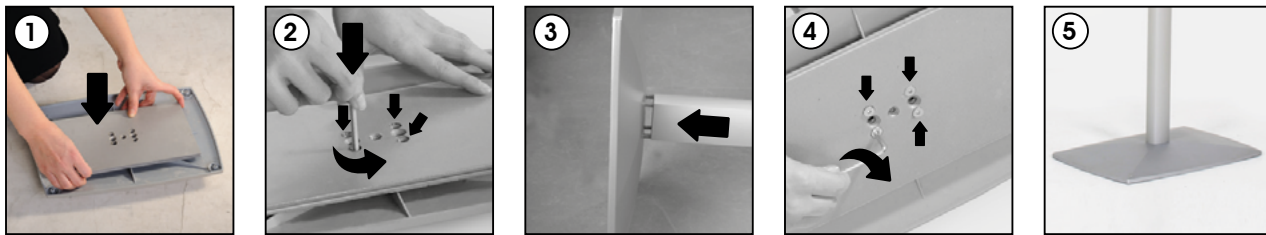

### Each product includes

- 1 x Base
- 1 x Main body pole
- 1 x A4 Brochure holder
- 1 x Brochure holder connector
- 1 x 3 allen key
- 4 x Bolt M5x50
- 2 x Bolt M4x10
- 2 x Nut M4

### A4 Brochure holder

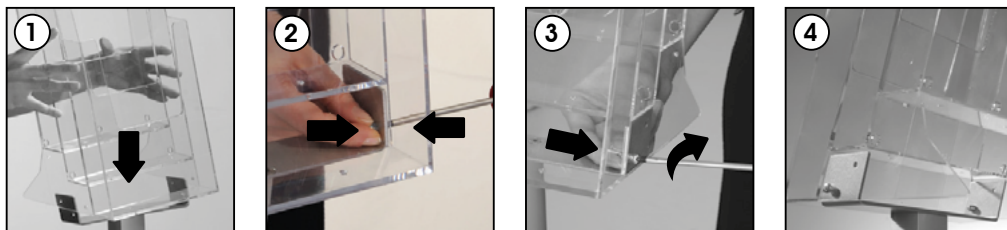

### Each product includes

- 1 x Base
- 1 x Main body pole
- 2 x 1/3 A4 brochure holder
- 1 x Brochure holder connector
- 1 x 3 allen key
- 4 x Bolt M5x50
- 3 x Bolt M4x10
- 3 x Nut M4

### 1/3 A4 Brochure holder

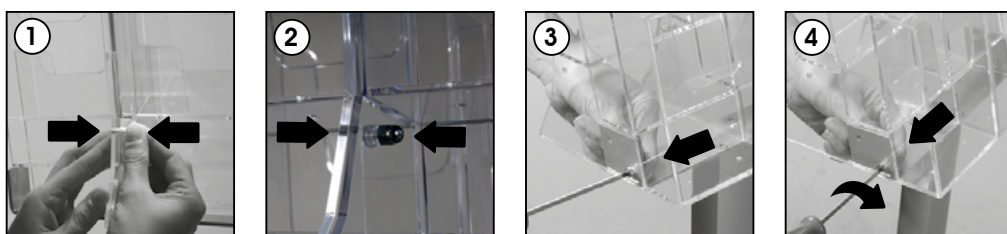

A4 Brochure holder

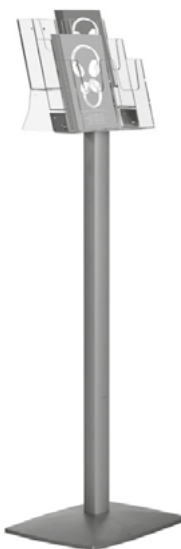

1/3 A4 Brochure holder

- Please inform the order number on the product or on the carton (e.g. 1/110001394-460) to the place that you have made the purchase if any problem with the product occurs.
- All rights reserved. All pictures, figures and writings are secured internationally by copy-right law. Infringements will be sued by civil and legal law.

This technical sheet's contents are all subject to update and modification at MT Displays' exclusive discretion. There is nothing official about this document. For final and legally binding information, please get in touch with the sales staff at MT Displays.

