

SWINGPRO® LITE



DOUBLE SIDED SIDEWALK SIGNS WITH FLEXIBLE SPRING DESIGN

SwingPro® Lite is heavy and robust waterbase pavement sign for outdoor. It consists of 2 main articles: frame and the base. No sharp edges and has steel springs for flexibility. Poster use is double sided. Recommended to use film posters.

KEY SELECTION ATTRIBUTES

* Double-sided Pavement Sign with swinging steel spring design for flexibility and stability.

* Patent protected (PCT/EP2018/060515) SwingPro Lite is heavy and robust pavement sign for OUTDOOR use with 2 main parts: frame and the base.

* Outdoorfriendly & Wind Resistant: Suitable for windy outdoor conditions. This product is not waterproof, but suitable to use outdoor.

* Suitable for 22"x28" (559x711 mm), 24"x36" (610x914 mm), 28"x44" (711x1117 mm), 30"x40" (762x1016 mm), A0 (841x1189 mm), A1 (594x841 mm), B1 (700x1000 mm) and B2 (500x700 mm) poster sizes. Recommended to use film posters.

* One set includes a double sided snap open 33 mm aluminium profile swing master frame with 28mm depth and round mitred corners for safety, 2 anti-reflex PET poster covers, 1 strong PP backing, nuts, spanners, heavy steel base profile with side feet, connection pipe, top and bottom brackets and washers for installation.

* Optional header accessories are available upon request, not included in standard set. If the frame of SwingPro Lite is required with a "HEADER" option, then the standard articles cannot be used, please contact our sales department for the articles with a header option.

* Heavy long feet on the base provide stability.

* Natural silver-anodized, black in standard and various RAL colors available with antimicrobial powder coating. Base standard in dark grey color or black, other colors are available upon request.

* Packed unassembled with an easy mounting instruction sheet & fixing set. Assembly in 65-75 seconds.

* Please use the wrench enclosed and tighten carefully. If tightened too much, the base can breach.

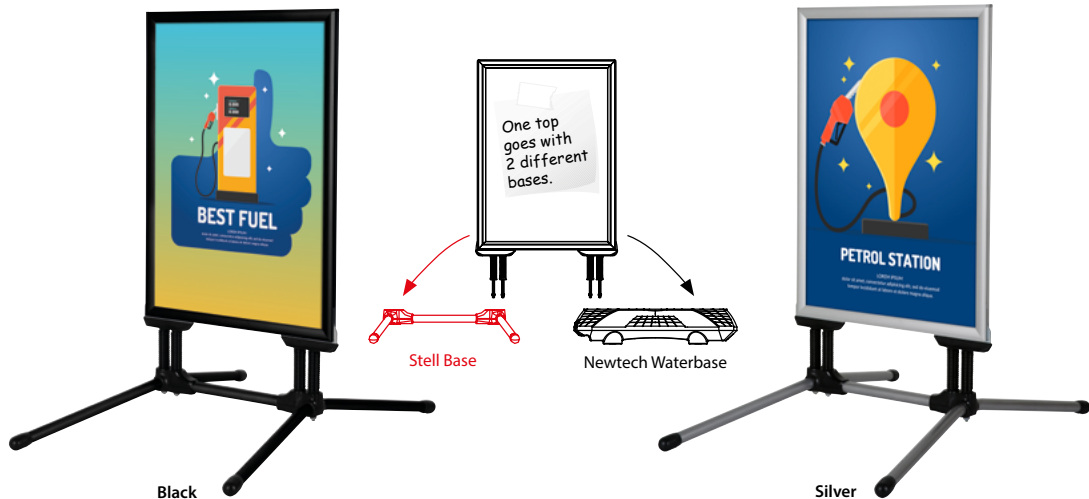

Black

Silver



COLOURS IN STOCK

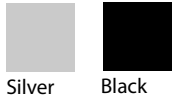

Silver Black

COLOUR OPTIONS

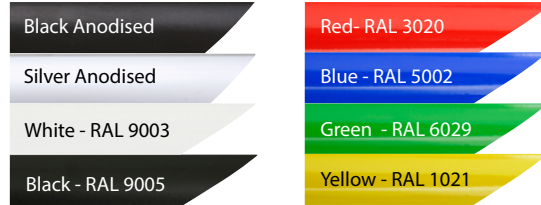

SUITABLE FOR

SwingPro Lite can be used for INDOOR and OUTDOOR applications, for signage needs in many locations like shopping centers, markets, groceries, hotels, offices airports, shops and stores, hospitals, schools, apartments and many more.

WATCH VIDEO



Watch video at our website
www.mtdisplays.com

FEATURES



EXPLODED VIEW



TECHNICAL DRAWING

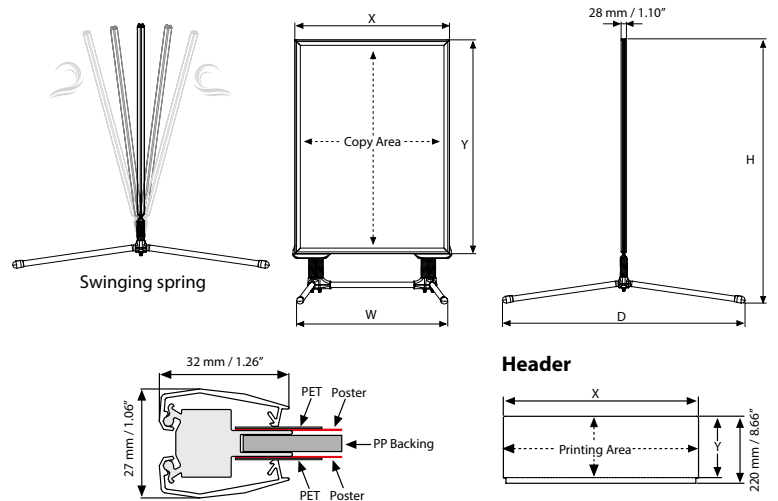

ARTICLES

FRAME					WEIGHT	PACKING SIZE
SILVER	BLACK	EXTERNAL (x-y)	POSTER	COPY	WITH PACKING	*W X H X D
USWPLOON1	USWPLO0BA1	632 X 879 mm	594 X 841 mm	568 X 815 mm	6,385 kg	680 X 1140 X 35 mm
USWPLOON10	USWPLO0BA0	879 X 1227 mm	841 X 1189 mm	815 X 1163 mm	9,000 kg	925 X 1490 X 35 mm
USWPLOON11	USWPLO0BB1	738 X 1038 mm	700 X 1000 mm	674 X 974 mm	8,115 kg	785 X 1300 X 35 mm
USWPLOON12	USWPLO0BB2	538 X 738 mm	500 X 700 mm	474 X 674 mm	5,050 kg	585 X 1000 X 35 mm
USWPLOON22	USWPLO0B22	23.50" X 29.49"	22" X 28"	20.98" X 26.98"	12,015 lbs	25.39" X 39.76" X 1.38"
USWPLOON24	USWPLO0B24	25.51" X 37.52"	24" X 36"	22.98" X 34.98"	14,418 lbs	27.17" X 47.83" X 1.38"
USWPLOON34	USWPLO0B34	31.50" X 41.50"	30" X 40"	28.98" X 38.98"	18,739 lbs	33.27" X 51.77" X 1.38"
USWPLOON84	USWPLO0B84	29.50" X 45.50"	28" X 44"	26.98" X 42.98"	19,841 lbs	31.30" X 55.71" X 1.38"

OPTIONAL ACCESSORIES



SwingPro® Lite & WindPro® Lite header (3 PVC Foam)

HEADER: 3 mm PVC Foam			WEIGHT
ARTICLE	SIZE	PRINTING AREA (x-y)	WITH PACKING
UYFT0040A1	594 X 841 mm	632 X 200 mm	2,650 kg
UYFT0040A0	841 X 1189 mm	879 X 200 mm	3,680 kg
UYFT0040B2	500 X 700 mm	538 X 200 mm	2,250 kg
UYFT0040B1	700 X 1000 mm	738 X 200 mm	3,090 kg
UYFT004022	22" X 28"	23.50" X 7.87"	0.551 lbs
UYFT004024	24" X 36"	25.51" X 7.87"	0.595 lbs
UYFT004034	30" X 40"	31.50" X 7.87"	0.738 lbs
UYFT004084	28" X 44"	29.53" X 7.87"	0.683 lbs

STEEL BASE							WEIGHT	PACKING SIZE	
SILVER	BLACK	SIZE	FOR	H	W	D	WITH PACKING	*W X H X D	
UTSM001000	UTSM001010	920 mm	22" X 28"	41.30"	27.17"	36.22"	7,716 lbs	8.66" X 38.19" X 1.85"	
		36.22"	B2	1038 mm	690 mm	920 mm	3,500 kg	220 X 970 X 47 mm	
UTSM002000	UTSM002010	1070 mm	A1	1179 mm	690 mm	1070 mm	4,000 kg	220 X 1180 X 47 mm	
		42.13"	24" X 36"	49.33"	27.17"	42.13"	8,818 lbs	8.66" X 46.46" X 1.85"	
UTSM003000	UTSM003010	1260 mm	B1	1338 mm	890 mm	1260 mm	4,600 kg	220 X 1310 X 47 mm	
		49.61"		30" X 40"	53.31"	35.04"	49.61"	10,141 lbs	8.66" X 51.57" X 1.85"
		49.61"		28" X 44"	57.28"	35.04"	49.61"	10,141 lbs	8.66" X 51.57" X 1.85"
UTSM004000	UTSM004010	1420 mm	A0	1527 mm	890 mm	1420 mm	5,600 kg	220 X 1480 X 47 mm	



T: +90 850 433 67 85 / info@mtdisplays.com / www.mtdisplays.com

PHYSICAL DATA

Material

33mm aluminium profile snap open swing master frame, PET anti-reflex poster cover, PP backing, steel profile base. Optional PVC Foam headers

Poster Material & Thickness

Recommended to use film posters. 0,10 – 0,20 mm for standard product. Max poster thickness is 2 mm for low density rigid posters such as PVC foam, PP, etc. Any non-standard poster thickness should be indicated with order.

Surface Finish

Natural silver-anodized, black in standard and various RAL colors available with antimicrobial powder coating. Base standard in dark grey color or black, other colors are available upon request. Call for custom color requests.

Recycled Content

Up to 78% recycled content used.

Warranty

All products are guaranteed for 2 years by MT Displays with below conditions:

[Warranty Conditions](#)

Storage Conditions

Goods should be stored at 0° to 25°C in a dry place. Store in the original package.

Installation Considerations

SwingPro Lite is packed unassembled with an easy mounting instruction sheet & fixing set. Assembly in 65-75 seconds. One set includes a double sided snap open 33 mm aluminium profile swing master frame with 28mm depth and round mitred corners for safety, 2 anti-reflex PET poster covers, 1 strong PP backing, nuts, spanners, heavy steel base profile with side feet, connection pipe, top and bottom brackets and washers for installation. Please use the wrench enclosed and tighten carefully. If tightened too much, the base can breach. Optional header accessories are available upon request, not included in standard set. If the frame of SwingPro Lite is required with a "HEADER" option, then the standard articles cannot be used, please contact our sales department for the articles with a header option.

Design Considerations

Double-sided Pavement Sign with swinging steel spring design for flexibility and stability. Patent protected SwingPro Lite is heavy and robust pavement sign for OUTDOOR use with 2 main parts: frame and the base. Outdoorfriendly & Wind Resistant: Suitable for windy outdoor conditions. This product is not waterproof, but suitable to use outdoor. Suitable for 22"x28" (559x711 mm), 24"x36" (610x914 mm), 28"x44" (711x1117 mm), 30"x40" (762x1016 mm), A0 (841x1189 mm), A1 (594x841 mm), B1 (700x1000 mm) and B2 (500x700 mm) poster sizes. Heavy long feet on the base provide stability.

Cleaning and Disinfecting

Clean your displays, with damp microfiber clothes, rinsed with simply water or warm, soapy or gentle shampooed water. Avoid using vinegar, abrasive, acidic, alcohol-based or heavy cleaners or cleaners containing Ammonia. Only after cleaning the product, if needed, simply apply disinfectant or sanitizer that is in compliance with your local guidelines and regulations.

Patent

OHIM DM/098 297, PCT/EP2018/060515

PRINT TEMPLATES

Swingpro Lite - A1

Document Size: 604 x 851 mm (Includes Bleeds)

Finished Size: A1 (594 x 841 mm) [Print](#)

Swingpro Lite - A0

Document Size: 851 x 1199 (Includes Bleeds)

Finished Size: A0 (841 x 1189 mm) [Print](#)

Swingpro Lite - B2

Document Size: 510 x 710 (Includes Bleeds)

Finished Size: B2 (500 x 700 mm) [Print](#)

Swingpro Lite - B1

Document Size: 710 x 1010 (Includes Bleeds)

Finished Size: B1 (700 x 1000 mm) [Print](#)

Swingpro Lite - 22" x 28"

Document Size: 22.4" x 28.4" (Includes Bleeds)

Finished Size: 22" x 28" (558.8 x 711.2 mm) [Print](#)

Swingpro Lite - 24" x 36"

Document Size: 24.4" x 36.4" (Includes Bleeds)

Finished Size: 24" x 36" (609,6 x 914,4 mm) [Print](#)

Swingpro Lite - 30" x 40"

Document Size: 30.4" x 40.4" (Includes Bleeds)

Finished Size: 30" x 40" (762 x 1016 mm) [Print](#)

Swingpro Lite - 28" x 44"

Document Size: 28.4 x 44.4 (Includes Bleeds)

Finished Size: 28" x 44" (711.2 x 1117 mm) [Print](#)



INSTALLATION INSTRUCTIONS

SwingPro® Lite / 1010321H000

SwingPro Lite Steel Base

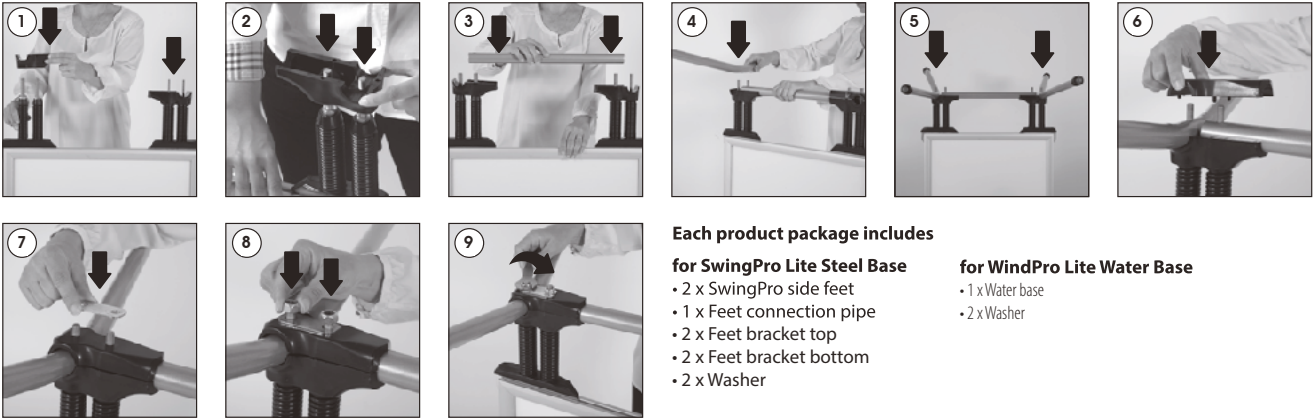

Each product package includes

for SwingPro Lite Steel Base

- 2 x SwingPro side feet
- 1 x Feet connection pipe
- 2 x Feet bracket top
- 2 x Feet bracket bottom
- 2 x Washer

for WindPro Lite Water Base

- 1 x Water base
- 2 x Washer

WindPro Lite Waterbase

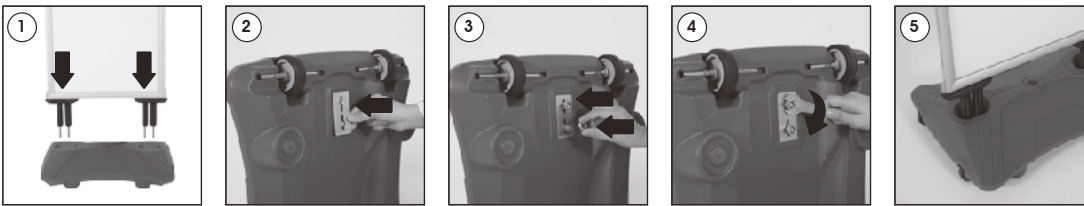

Poster Change

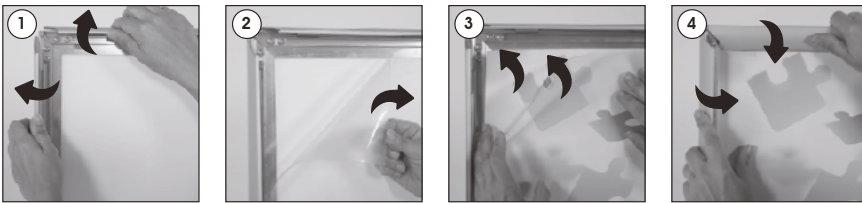

Each product package includes for Frame

- 1 x SwingPro Lite & WindPro Lite Frame
- 2 x PET cover
- 4 x Nut M10
- 1 x 17 spanner

WARNING!

- Please use the wrench enclosed and tighten carefully. When tighten too much, the base can breach.
- It is recommend to carry the product with the tool as shown (optional available), when the base is full with water.



- Please inform the order number on the product or on the carton (e.g. 1/110001394-460) to the place that you have made the purchase if any problem with the product occurs.
- All rights reserved. All pictures, figures and writings are secured internationally by copy-right law. Infringements will be sued by civil and legal law.

This technical sheet's contents are all subject to update and modification at MT Displays' exclusive discretion. There is nothing official about this document. For final and legally binding information, please get in touch with the sales staff at MT Displays.



T: +90 850 433 67 85 / info@mtdisplays.com / www.mtdisplays.com