

WINDOW FRAME



HARD-TO-OPEN FRAMES FOR WINDOW PRESENTATION OF YOUR POSTERS

The Window Frame system is available in 25 mm or 32 mm, hard-to-open, secure profiles. The Window Frames are designed for window mounted presentation of medium and small size posters from both inside and outside, for this purpose there is a surrounding strong double-sided tape at the back of each frame. The system includes decorative back profile to hide the double-sided adhesive tape which holds the frame to the window. Window Frames are easy to use only by opening the front profile. You just need to flip up all four sides and place the first plastic protective cover, then the first poster facing outside, the second poster is placed facing inside and lastly place the second plastic protective cover.

KEY SELECTION ATTRIBUTES

- * Available for indoor & outdoor usage
- * Suitable for open-air use or highly frequented public areas.
- * Ideal for medium-sized posters.
- * Hard-to-open, secure profile.
- * Natural silver-anodized and various RAL colors. available with antimicrobial powder coating.
- * Standard mitred corners.
- * Easy poster changing by "peel&stick" fixing.
- * Double sided adhesive tape holds up the frame.
- * Easy to change the poster by opening front profile.
- * Suitable for both portrait and landscape positions.
- * Anti-glare poster cover sheets.



25 mm



32 mm



COLOURS IN STOCK



Silver Black

COLOUR OPTIONS

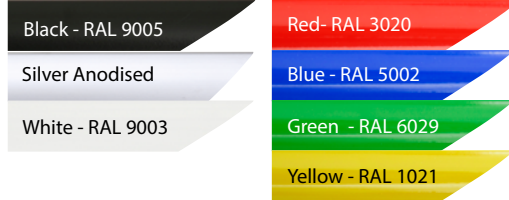

CORNER TYPES

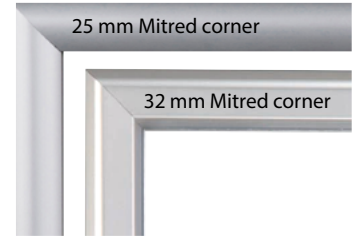

SUITABLE FOR

Window Frames can be used for INDOOR and OUTDOOR applications, for signage needs in many locations like shopping centers, markets, groceries, hotels, offices airports, shops and stores, hospitals, schools, banks, car dealers, insurance companies, telecom companies, travel agencies, museums, restaurants, theatres for commercial advertising, or to change menus and specials deals at restaurants and many more.

WATCH VIDEO



Watch video at our website
www.mtdisplays.com

FEATURES

25 mm



32 mm

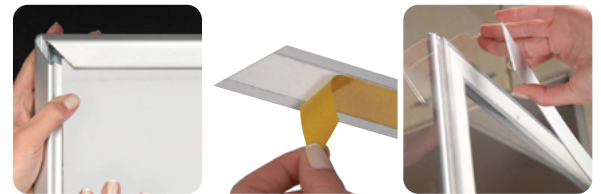

EXPLODED VIEW

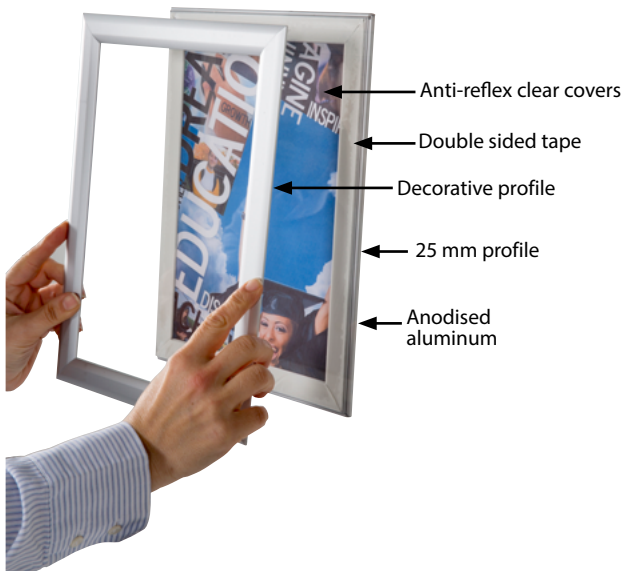

TECHNICAL DRAWING

25 mm

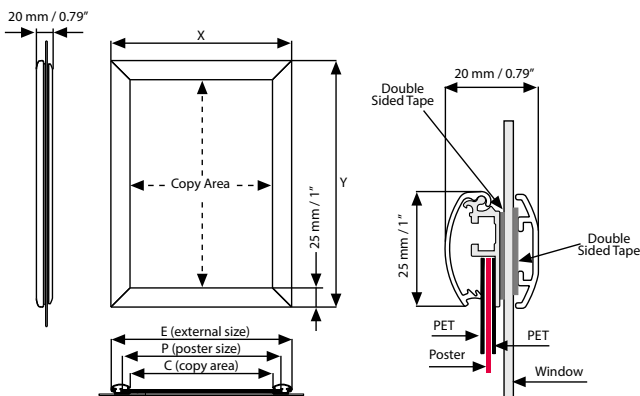

32 mm

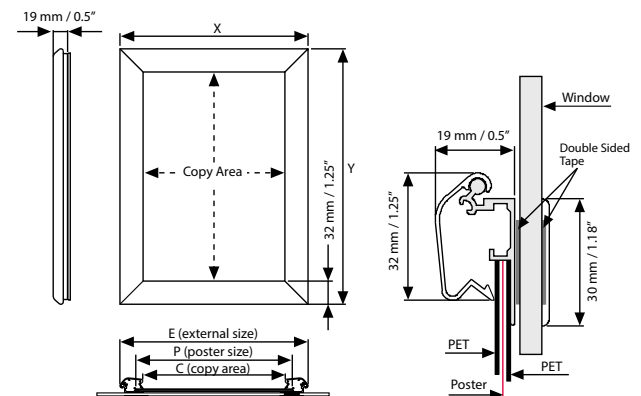

T: +90 850 433 67 85 / info@mtdisplays.com / www.mtdisplays.com

ARTICLES

PROFILE : 25 mm 45°				WEIGHT WITH PACKING	PACKING SIZE *W X H X D
ARTICLE	EXTERNAL (x-y)	POSTER	COPY		
UCW255N4A4	240 X 327 mm	210 X 297 mm	192 X 279 mm	0,620 kg	260 X 350 X 21 mm
UCW255N4A3	327 X 450 mm	297 X 420 mm	279 X 402 mm	0,900 kg	350 X 460 X 21 mm
UCW255N4A2	450 X 624 mm	420 X 594 mm	402 X 576 mm	1,075 kg	460 X 660 X 21 mm
UCW255N4A1	624 X 871 mm	594 X 841 mm	576 X 823 mm	2,070 kg	650 X 900 X 21 mm
UCW255N4B2	530 X 730 mm	500 X 700 mm	482 X 682 mm	1,350 kg	550 X 750 X 21 mm
UCW255N4B1	730 X 1030 mm	700 X 1000 mm	682 X 982 mm	2,700 kg	750 X 1050 X 21 mm
UCW255N481	9.69" X 12.17"	8.5" X 11"	7.80" X 10.28"	1.102 lbs	10.63" X 12.99" X 0.83"
UCW255N417	12.17" X 18.19"	11" X 17"	10.28" X 16.30"	1.873 lbs	12.99" X 18.90" X 0.83"
UCW255N422	23.19" X 29.17"	22" X 28"	21.30" X 27.28"	3.637 lbs	24.02" X 30.31" X 0.83"
UCW255N423	21.18" X 31.18"	20" X 30"	19.29" X 29.29"	3.637 lbs	22.44" X 32.28" X 1.22"
UCW255N434	31.18" X 41.18"	30" X 40"	29.29" X 39.29"	6.944 lbs	31.89" X 42.13" X 0.91"
UCW255N446	41.18" X 61.18"	40" X 60"	39.29" X 59.29"	13.227 lbs	41.73" X 61.81" X 0.91"

PROFILE : 32 mm 45°				WEIGHT WITH PACKING	PACKING SIZE *W X H X D
ARTICLE	EXTERNAL (x-y)	POSTER	COPY		
UCW325N4A4	253 X 340 mm	210 X 297 mm	190 X 277 mm	0,810 kg	260 X 360 X 31 mm
UCW325N4A3	340 X 463 mm	297 X 420 mm	277 X 400 mm	1,020 kg	360 X 480 X 31 mm
UCW325N4A2	463 X 637 mm	420 X 594 mm	400 X 574 mm	1,680 kg	460 X 670 X 31 mm
UCW325N4A1	637 X 884 mm	594 X 841 mm	574 X 821 mm	2,580 kg	660 X 910 X 31 mm
UCW325N4A0	884 X 1232 mm	841 X 1189 mm	821 X 1169 mm	4,600 kg	910 X 1270 X 31 mm
UCW325N4B2	543 X 743 mm	500 X 700 mm	480 X 680 mm	1,950 kg	560 X 760 X 31 mm
UCW325N4B1	743 X 1043 mm	700 X 1000 mm	680 X 980 mm	3,500 kg	760 X 1060 X 31 mm
UCW325N4B0	1043 X 1443 mm	1000 X 1400 mm	980 X 1380 mm	6,000 kg	1060 X 1460 X 31 mm
UCW325N423	21.69" X 31.69"	20" X 30"	19.21" X 29.21"	4.519 lbs	22.44" X 32.28" X 1.22"
UCW325N434	31.69" X 41.69"	30" X 40"	29.21" X 39.21"	7.936 lbs	32.28" X 42.52" X 1.22"
UCW325N446	41.69" X 61.69"	40" X 60"	39.21" X 59.21"	14.881 lbs	41.73" X 61.81" X 1.22"

PHYSICAL DATA

Material

25 mm and 32 mm aluminum profiles.
2 PET poster covers.

Poster Material & Thickness

0,10 – 0,20 mm for standard product. Max poster thickness 3 mm for 25 mm profile, 5 mm for 32 mm profile. Any non-standard poster thicknesses should be indicated with order.

Surface Finish

Silver anodized, or black colour, antimicrobial powder coating. Custom colors also available, call for custom color requests.

Recycled Content

Up to 78% recycled content used.

Warranty

All products are guaranteed for 3 years by MT Displays with below conditions:

[Warranty Conditions](#)

Installation Considerations

Double PET cover, double-sided tape a round the frame internal & external. Each frame is packed individually in a cardboard box. Please clean the surface before applying the double-sided tape for better application.

Storage Conditions

Goods should be stored at 0° to 25°C in a dry place. Store in the original package.

Design Considerations

Suitable for silk screen printing, max. letter height is 15 mm.

Cleaning and Disinfecting

Clean your displays, with damp microfiber clothes, rinsed with simply water or warm, soapy or gentle shampooed water. Avoid using vinegar, abrasive, acidic, alcohol-based or heavy cleaners or cleaners containing Ammonia. Only after cleaning the product, if needed, simply apply disinfectant or sanitizer that is in compliance with your local guidelines and regulations.

Certifications / Patents

PRINT TEMPLATES

Window Frame 25 mm - A4

Document Size: 220 x 307 mm (Includes Bleeds)
Finished Size: A4 (210 x 297 mm) [Print](#)

Window Frame 25 mm - A3

Document Size: 307 x 430 mm (Includes Bleeds)
Finished Size: A3 (297 x 420 mm) [Print](#)

Window Frame 25 mm - A2

Document Size: 430 x 604 mm (Includes Bleeds)
Finished Size: A2 (420 x 594 mm) [Print](#)

Window Frame 25 mm - A1

Document Size: 604 x 851 mm (Includes Bleeds)
Finished Size: A1 (594 x 841 mm) [Print](#)

Window Frame 32 mm - A4

Document Size: 220 x 307 mm (Includes Bleeds)
Finished Size: A4 (210 x 297 mm) [Print](#)

Window Frame 32 mm - A3

Document Size: 307 x 430 mm (Includes Bleeds)
Finished Size: A3 (297 x 420 mm) [Print](#)

Window Frame 32 mm - A2

Document Size: 430 x 604 mm (Includes Bleeds)
Finished Size: A2 (420 x 594 mm) [Print](#)

Window Frame 32 mm - A1

Document Size: 604 x 851 mm (Includes Bleeds)
Finished Size: A1 (594 x 841 mm) [Print](#)

Window Frame 25 mm - B2

Document Size: 510 x 710 mm (Includes Bleeds)
Finished Size: B2 (500 x 700 mm) [Print](#)

Window Frame 25 mm - B1

Document Size: 710 x 1010 mm (Includes Bleeds)
Finished Size: B1 (700 x 1000 mm) [Print](#)

Window Frame 1" - 8.5"x11"

Document Size: 8.9" x 11.4" (Includes Bleeds)
Finished Size: 8.5"x11" (215.9x279.4 mm)

Window Frame 1" - 11"x17"

Document Size: 11.4" x 17.4" (Includes Bleeds)
Finished Size: 11"x17" (279.4x431.8 mm)

Window Frame 32 mm - A0

Document Size: 851 x 1199 mm (Includes Bleeds)
Finished Size: A0 (841 x 1189 mm) [Print](#)

Window Frame 32 mm - B2

Document Size: 510 x 710 mm (Includes Bleeds)
Finished Size: B2 (500 x 700 mm) [Print](#)

Window Frame 32 mm - B1

Document Size: 710 x 1010 mm (Includes Bleeds)
Finished Size: B1 (700 x 1000 mm) [Print](#)

Window Frame 32 mm - B0

Document Size: 1010 x 1410 mm (Includes Bleeds)
Finished Size: B1 (1000 x 1400 mm) [Print](#)

Window Frame 1" - 20"x30"

Document Size: 20.4" x 30.4" (Includes Bleeds)
Finished Size: 20"x30" (508x762 mm) [Print](#)

Window Frame 1" - 22"x28"

Document Size: 22.4" x 28.4" (Includes Bleeds)
Finished Size: 22"x28" (558.8x711.1 mm)

Window Frame 1" - 30"x40"

Document Size: 30.4" x 40.4" (Includes Bleeds)
Finished Size: 30"x40" (762x1016 mm) [Print](#)

Window Frame 1" - 40"x60"

Document Size: 40.4" x 60.4" (Includes Bleeds)
Finished Size: 40"x60" (1016x1524 mm) [Print](#)

Window Frame 1.25" - 20"x30"

Document Size: 20.4" x 30.4" (Includes Bleeds)
Finished Size: 20"x30" (508x762 mm) [Print](#)

Window Frame 1.25" - 30"x40"

Document Size: 30.4" x 40.4" (Includes Bleeds)
Finished Size: 30"x40" (762x1016 mm) [Print](#)

Window Frame 1.25" - 40"x60"

Document Size: 40.4" x 60.4" (Includes Bleeds)
Finished Size: 40"x60" (1016x1524 mm)



INSTALLATION INSTRUCTIONS

Window Frame 25 mm / 1010295H000

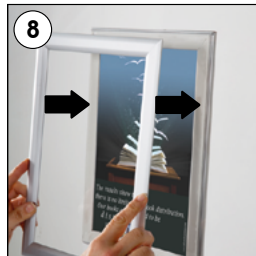
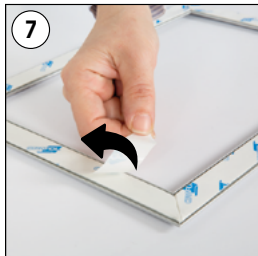
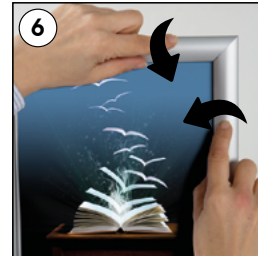
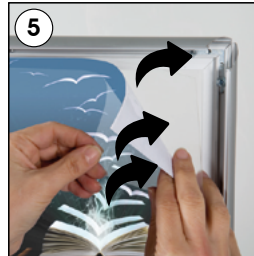
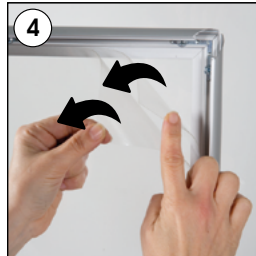
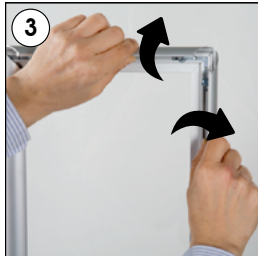
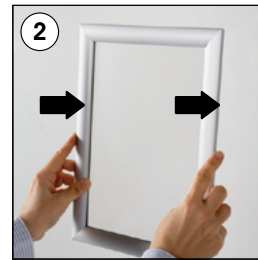
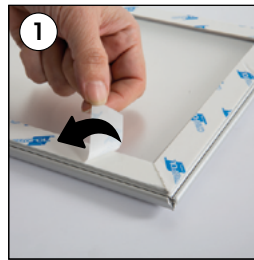
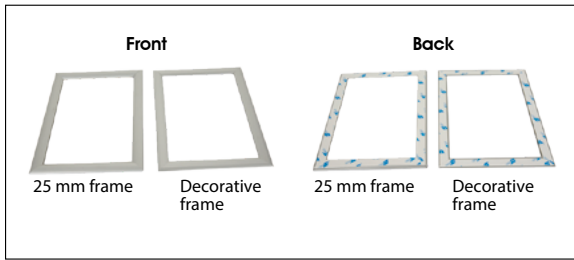

Each Frame includes double PET cover and double-sided tape around the frame internal & external.

CAUTION

For the best application of adhesive tape to window, the applied surface must be dry, clean & flat.



- Please inform the order number on the product or on the carton (e.g. 1/110001394-460) to the place that you have made the purchase if any problem with the product occurs.
- All rights reserved. All pictures, figures and writings are secured internationally by copy-right law. Infringements will be sued by civil and legal law.



T: +90 850 433 67 85 / info@mtdisplays.com / www.mtdisplays.com

INSTALLATION INSTRUCTIONS

Window Frame 32 mm / 1001859

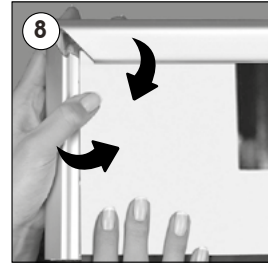
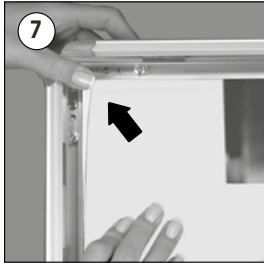
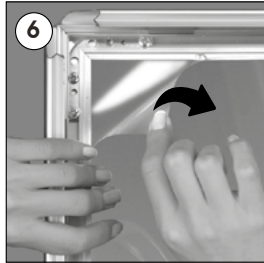
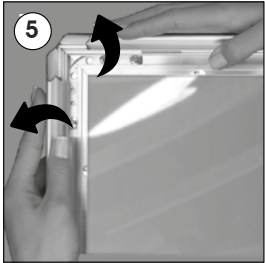
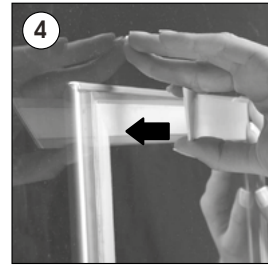
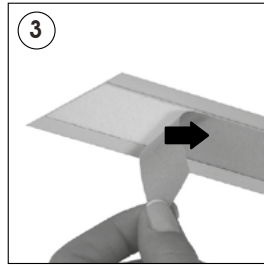
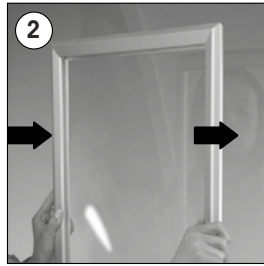
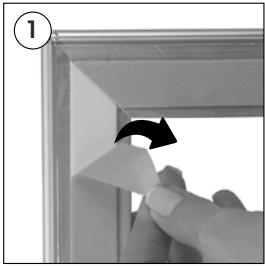

Each Frame includes double PET cover and double-sided tape around the frame internal & external.

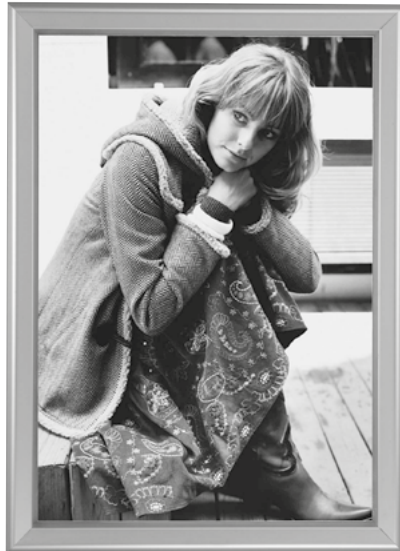

CAUTION

For the best application of adhesive tape to window, the applied surface must be dry, clean & flat.

- Please inform the order number on the product or on the carton (e.g. 1/110001394-460) to the place that you have made the purchase if any problem with the product occurs.
- All rights reserved. All pictures, figures and writings are secured internationally by copy-right law. Infringements will be sued by civil and legal law.

This technical sheet's contents are all subject to update and modification at MT Displays' exclusive discretion. There is nothing official about this document. For final and legally binding information, please get in touch with the sales staff at MT Displays.



T: +90 850 433 67 85 / info@mtdisplays.com / www.mtdisplays.com