

WOOD SLIDE-IN FRAME



EASY WOOD FRAMES WITH DOUBLE-SIDED SLIDE-IN CHALK BOARD

Wood Podium is made of Beech plywood wood. It is a good lectern solution with 15 degrees viewing angle for ergonomic posture. It has an interior shelf for keeping notes and presentation materials organized. Poster clamp in front of the stand allows you to present your brand's logo for a professional fixture. Can be used at business conferences, universities, hotels, or even trade shows. To ensure sustainability of the quality, wood podium holders are lacquered finished.

KEY SELECTION ATTRIBUTES

- * Practical Beech Wood Slide-in Frame with black chalk board for single-sided wall-mounting or double-sided hanger-mounting options.
- * A perfect way to present removable messages, announcements or promotions to your audience while keeping them updated.
- * Suitable for both usage in landscape and portrait position with optional A1, A2, A3, A4, 8.5"x11", 11"x17", 18"x24", 22"x28", 24"x36" writing areas.
- * One set includes natural beech wood slide-in frame with 21mm thickness and lacquered finish for durability; a double-sided dry wipe black chalkboard with 4mm thickness for changing notes easily by sliding-in and out from top of the frame; anchors, hangers and screws for installing on wall or hanging for double-sided usage.
- * For hanging from ceiling hangers can be mounted at the corner. Wire cable is not included in the package. Please order separately if needed.
- * Suitable for using chalk or chalkboard water-based pen. Chalkboard pens are not included in the original pack, should be ordered separately. For spotless removing of chalk pens from surface, please use window & glass cleaner otherwise clean with damp cloth.
- * Natural Beech Wood and Dark Beech Wood frame with lacquered finish and a double sided black chalk board in standard.
- * Packed unassembled in a single box with fixing elements and easy-to-understand instruction sheet. See info chart for pack sizes. Assembly time approx 120 seconds.



Natural wood



Dark wood



COLOURS IN STOCK



Natural Wood Dark Wood

SUITABLE FOR

Wood Slide-in Frames can be used for INDOOR applications, for signage needs in many locations like shopping centers, markets, groceries, hotels, offices airports, shops and stores, hospitals, schools, apartments and many more.

WATCH VIDEO



Watch video at our website www.mtdisplays.com

FEATURES



Landscape or portrait positions

Hanger mounting for double sided use.

EXPLODED VIEW

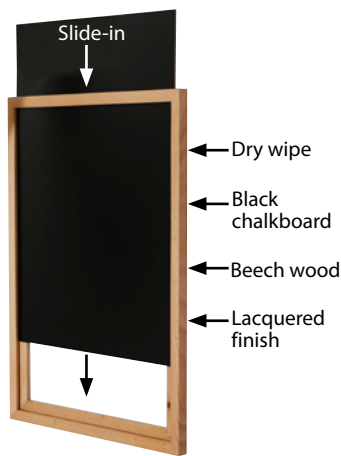

TECHNICAL DRAWING

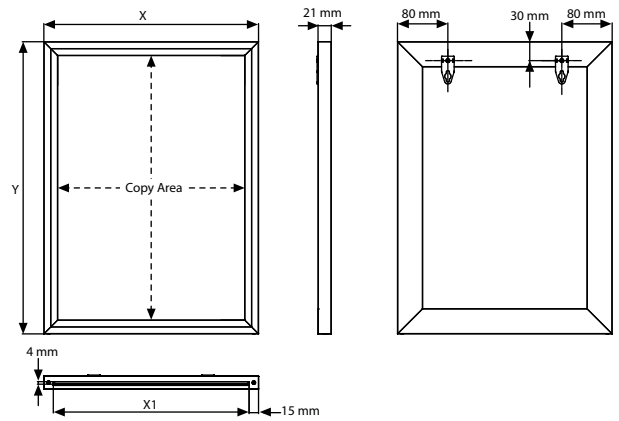

ARTICLES

DARK WOOD	NATURAL WOOD	EXTERNAL (x-y)	COPY AREA	X1	WEIGHT	PACKING SIZE
					WITH PACKING	*W X H X D
UWSFD000A4	UWSFN000A4	254 X 341 mm	210 X 297 mm	224 mm	0,590 kg	280 X 370 X 30 mm
UWSFD000A3	UWSFN000A3	341 X 464 mm	297 X 420 mm	311 mm	0,960 kg	370 X 490 X 30 mm
UWSFD000A2	UWSFN000A2	464 X 638 mm	420 X 594 mm	434 mm	1,550 kg	490 X 660 X 30 mm
UWSFD000A1	UWSFN000A1	638 X 885 mm	594 X 841 mm	608 mm	2,600 kg	670 X 910 X 30 mm
UWSFD00081	UWSFN00081	10.24" X 12.76"	8.5" X 11"	9.06"	0,580 kg	11.02" X 13.39" X 1.18"
UWSFD00017	UWSFN00017	12.76" X 18.74"	11" X 17"	11.57"	0,950 kg	13.39" X 19.69" X 1.18"
UWSFD00018	UWSFN00018	18.74" X 25.75"	18" X 24"	18.58"	1,650 kg	20.47" X 26.38" X 1.18"
UWSFD00022	UWSFN00022	23.74" X 29.76"	22" X 28"	22.56"	2,200 kg	24.41" X 30.31" X 1.18"
UWSFD00024	UWSFN00024	25.75" X 37.76"	24" X 36"	24.57"	2,900 kg	26.77" X 35.58" X 1.18"

OPTIONAL ACCESSORIES



Colour chalkboard marker. 10 mm wide. 5 Pcs. / UYAKLM1251



White chalkboard marker for Wood Display. 10 mm wide. 3 Pcs / UYAKLM1250



PHYSICAL DATA

Material

Beech Wood slide-in frame with 21 mm depth, black chalkboard with 4mm thickness.

Surface Finish

Natural Beech Wood and Dark Beech Wood frame with lacquered finish and a double sided black chalk board in standard.

Warranty

All products are guaranteed for 1 years by MT Displays with below conditions:

[Warranty Conditions](#)

Storage Conditions

Goods should be stored at 0° to 25°C in a dry place. Store in the original package.

Installation Considerations

Packed unassembled in a single box with fixing elements and easy-to-understand instruction sheet. See info chart for pack sizes. Assembly time approx 120 seconds. One set includes natural beech wood slide-in frame with 21mm thickness and lacquered finish for durability; a double-sided dry wipe black chalkboard with 4mm thickness for changing notes easily by sliding-in and out from top of the frame; anchors, hangers and screws for installing on wall or hanging for double-sided usage.

For hanging from ceiling hangers can be mounted at the corner. Wire cable is not included in the package. Please order separately if needed. Suitable for using chalk or chalkboard water-based pen. Chalkboard pens are not included in the original pack, should be ordered separately. For spotless removing of chalk pens from surface, please use window & glass cleaner otherwise clean with damp cloth.

Design Considerations

Practical Beech Wood Slide-in Frame with black chalk board for single-sided wall-mounting or double-sided hanger-mounting options. A perfect way to present removable messages, announcements or promotions to your audience while keeping them updated. Suitable for both usage in landscape and portrait position with optional A1, A2, A3, A4, 8.5"x11", 11"x17", 18"x24", 22"x28", 24"x36" writing areas.

Cleaning and Disinfecting

Clean your displays, with damp microfiber clothes, rinsed with simply water or warm, soapy or gentle shampooed water. Avoid using vinegar, abrasive, acidic, alcohol-based or heavy cleaners or cleaners containing Ammonia. Only after cleaning the product, if needed, simply apply disinfectant or sanitizer that is in compliance with your local guidelines and regulations.

INSTALLATION INSTRUCTIONS

Wood Slide-in Frame / 1011793H000

Wall mounting use

Each product includes

- 1 x Black Chalk Panel
- 2 x Screws & anchors
- 2 x Screw 3,5x9,5 mm
- 2 x Hanger

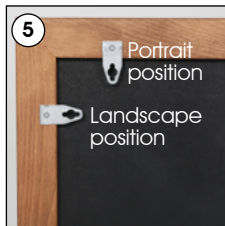
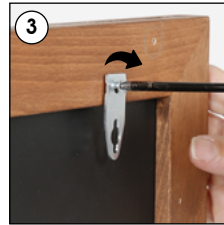
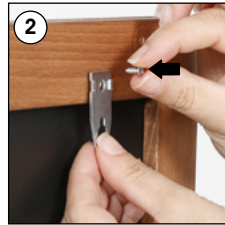
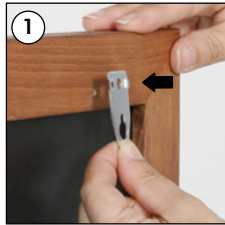

Slide-in panel



Ceiling hanger mounting use

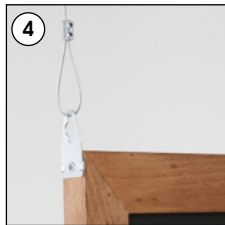
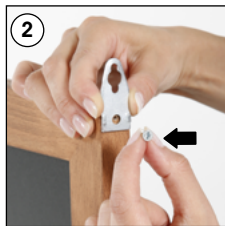
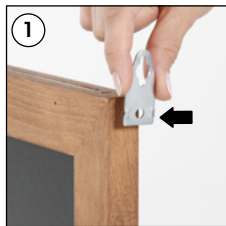

Wire cable not included in the pack.

- Please inform the order number on the product or on the carton (e.g. 1/110001394-460) to the place that you have made the purchase if any problem with the product occurs.
- All rights reserved. All pictures, figures and writings are secured internationally by copy-right law. Infringements will be sued by civil and legal law.

This technical sheet's contents are all subject to update and modification at MT Displays' exclusive discretion. There is nothing official about this document. For final and legally binding information, please get in touch with the sales staff at MT Displays.

