

## WOODEN ROLL STAND



### STYLISH WOODEN STANDS FOR ORGANIZING ROLLS

Wooden Roll Stand is made of plywood. Lacquered finish is applied for long term use. It has 9 rolls capacity. It has 4 wheels that 2 of them are caster wheels. Equipped with handle for easy carriage.

### KEY SELECTION ATTRIBUTES

- \* Wooden Roll Stands are stylish solutions, designed for carrying and organizing rolls while saving from space.
- \* Suitable for INDOOR use with 9 rolls carriage capacity.
- \* One set includes 480x480x18mm natural plywood base equipped with a side handle and 4 wheels below for easy transport, 9 natural plywood roll stands with 75mm diameter (Ø) and 253mm height and lacquered finish for durability, 18 screws and 1 allen key for installation.
- \* Natural plywood base and roll stands with lacquered finish in standard.
- \* The product is packed unassembled in a single box with an easy-to-understand instruction sheet and fixing elements.
- \* Assembly in 10 seconds.



## COLOURS IN STOCK



Natural Wood

## SUITABLE FOR

Wooden Roll Stand can be used for INDOOR applications, for organizing rolls needs in many locations like shopping centers, markets, groceries, hotels, offices airports, shops and stores, hospitals, schools, apartments and many more.

## FEATURES



## EXPLODED VIEW

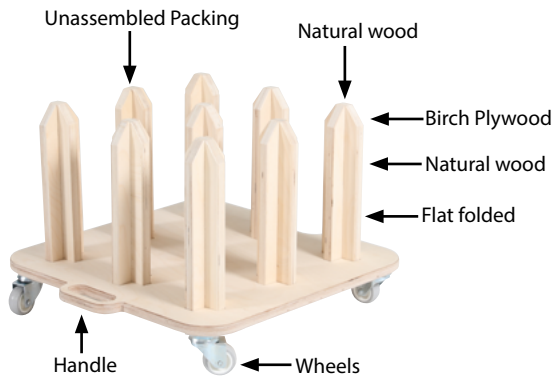

## TECHNICAL DRAWING

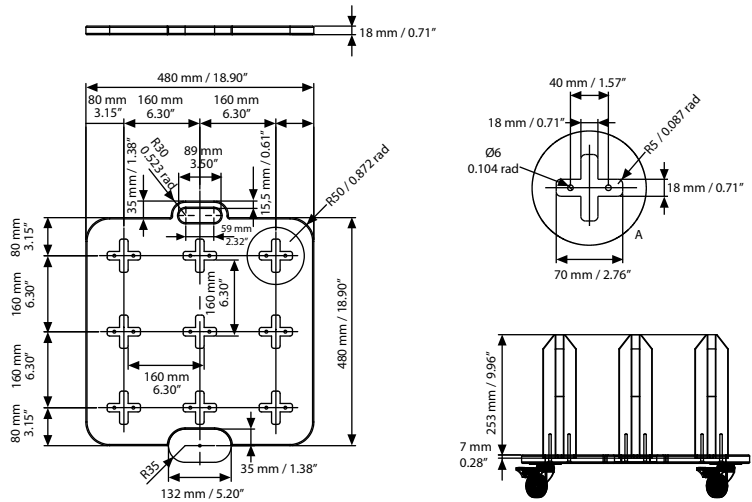

## ARTICLES

| ARTICLE    | SIZE         | DESCRIPTION  | WEIGHT       | PACKING SIZE       |
|------------|--------------|--------------|--------------|--------------------|
|            |              |              | WITH PACKING | *W X H X D         |
| UWRSON0000 | 480 X 480 mm | Natural Wood | 8,800 kg     | 500 X 540 X 100 mm |

## PHYSICAL DATA

### Material

Solid plywood base and roll stands.

### Surface Finish

Natural plywood base and roll stands with lacquered finish in standard.

### Warranty

All products are guaranteed for 1 years by MT Displays with below conditions:

[Warranty Conditions](#)

### Storage Conditions

Goods should be stored at 0° to 25°C in a dry place. Store in the original package.

### Installation Considerations

The product is packed unassembled in a single box with an easy-to understand instruction sheet and fixing elements. Assembly in 10 seconds. One set includes 480x480x18mm natural plywood base equipped with a side handle and 4 wheels below for easy transport, 9 natural plywood roll stands with 75mm diameter (Ø) and 253mm height and lacquered finish for durability, 18 screws and 1 allen key for installation.

### Design Considerations

Wooden Roll Stands are stylish solutions, designed for carrying and organizing rolls while saving from space. Suitable for INDOOR use with 9 rolls carriage capacity.

### Cleaning and Disinfecting

Clean your displays, with damp microfiber clothes, rinsed with simply water or warm, soapy or gentle shampooed water. Avoid using vinegar, abrasive, acidic, alcohol-based or heavy cleaners or cleaners containing Ammonia. Only after cleaning the product, if needed, simply apply disinfectant or sanitizer that is in compliance with your local guidelines and regulations.



T: +90 850 433 67 85 / info@mtdisplays.com / www.mtdisplays.com

# INSTALLATION INSTRUCTIONS

## Wooden Roll Stand/ 1012902H000

### Each product includes

- 1 x Roll Stand Base (480 x 480 x 18 mm)
- 9 x Roll stand
- 18 x Screw 6,3 x 50 mm
- 1 x 4 allen key

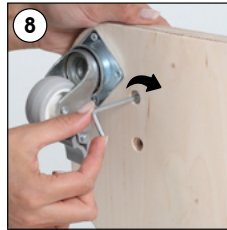
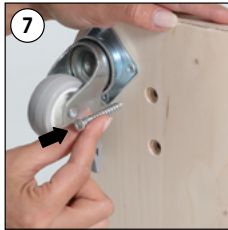
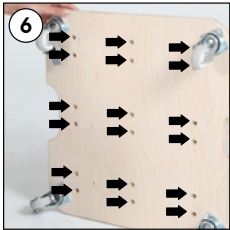
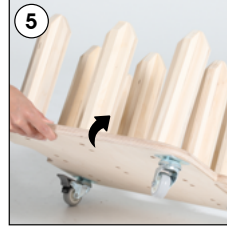
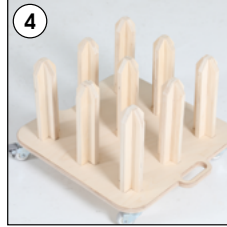
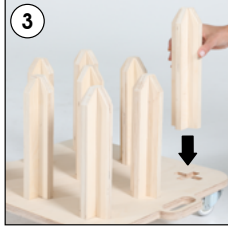
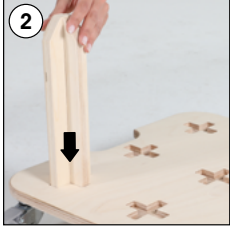
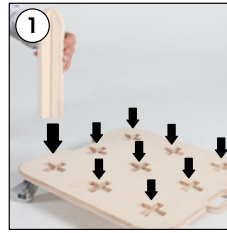
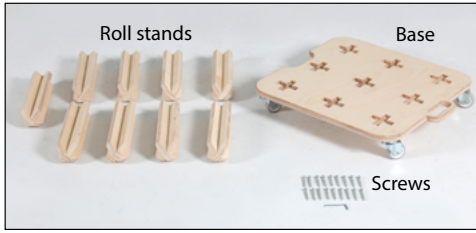

- Please inform the order number on the product or on the carton (e.g. 1/110001394-460) to the place that you have made the purchase if any problem with the product occurs.
- All rights reserved. All pictures, figures and writings are secured internationally by copy-right law. Infringements will be sued by civil and legal law.

