

ANGLED BICYCLE WALL STAND



PARKING AND GUARDING BIKES SAFELY ON THE GROUND

Angled Bicycle Wall Stand is suitable for wall mounting. It is made of hot sturdy galvanised steel. Angled Bicycle Wall Stand offers a perfect solution for storage. It is the best secure option for protecting your bike from theft. One module includes 2 stopper and 1 bicycle wall stand. The angle can be adjusted by widening the top screw. 2 screw and anchor are included for assembly.

KEY SELECTION ATTRIBUTES

- * Wall mounting Bicycle Stands with steel profiles for storing and protecting bikes from theft.
- * Suitable for OUTDOOR public spaces with capacity to store 1 bike in one single module.
- * In order to attach and securely store a bike on a wall, a set comes with two pieces of 300x300mm hot, robust, galvanized steel pipe profiles with a 360mm total extension from the wall and a 35x310x3mm bracket with two fastening slots, two screws, two anchors, and two stoppers.

- * Angle can be adjusted by widening the top screw.
- * Galvanised steel in standard and various RAL colors available with antimicrobial powder coating.
- * The product is packed with an easy-to-understand instruction sheet & fixing elements. Assembly in 60 seconds.

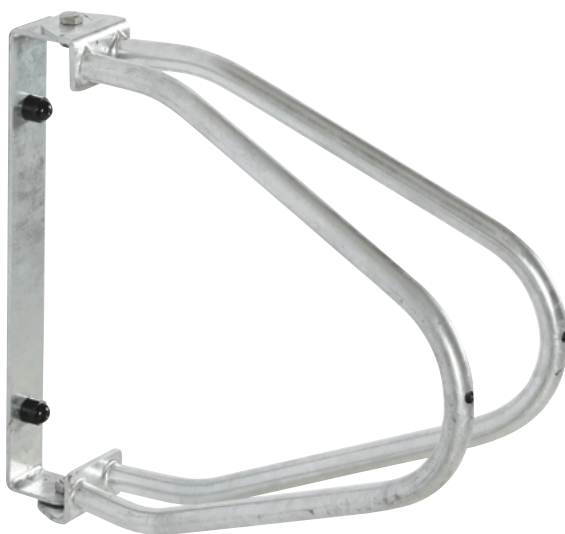

COLOURS IN STOCK



Silver

COLOUR OPTIONS

Black Anodised

White - RAL 9003

Red - RAL 3020

Green - RAL 6029

Silver Anodised

Black - RAL 9005

Blue - RAL 5002

Yellow - RAL 1021

SUITABLE FOR

Bicycle Stands can be used for OUTDOOR applications, for signage needs in many locations like shopping centers, markets, groceries, hotels, offices airports, shops and stores, hospitals, schools, apartments and many more.

WATCH VIDEO



Watch video at our website www.mtdisplays.com

FEATURES



EXPLODED VIEW

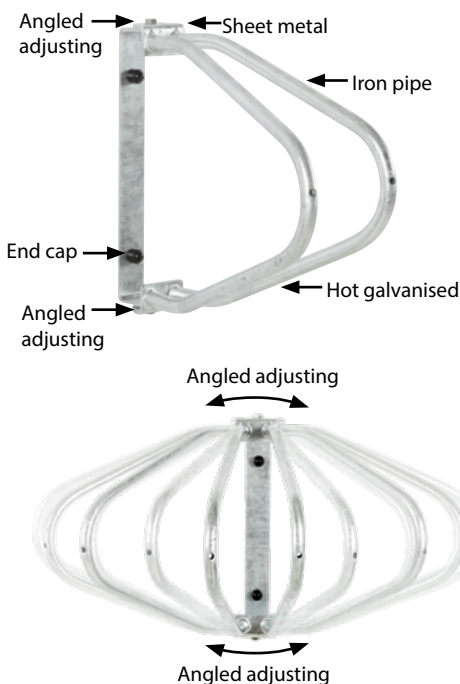

TECHNICAL DRAWING

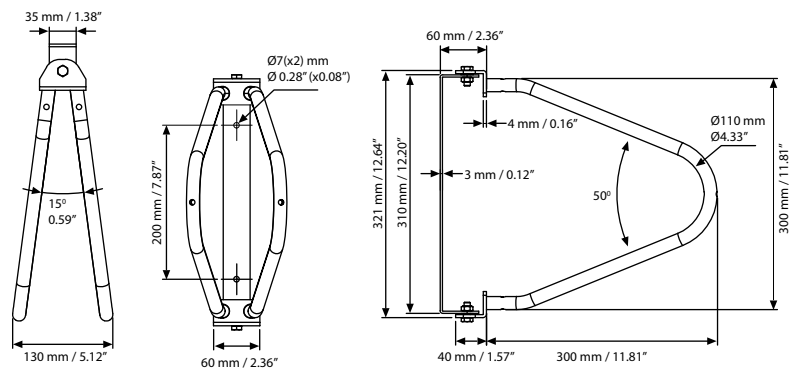

ARTICLES

ARTICLE	DESCRIPTION	WEIGHT	PACKING SIZE
		WITH PACKING	*W X H X D
UOBS001000	Hot Galvanised	7,250 kg	470 X 780 X 165 mm

PHYSICAL DATA

Material

Hot sturdy galvanised steel bracket and pipes.

Surface Finish

Galvanised steel in standard and various RAL colors available with antimicrobial powder coating. Call for custom color requests.

Recycled Content

Up to 78% recycled content used.

Warranty

All products are guaranteed for 3 years by MT Displays with below conditions: [Warranty Conditions](#)

Storage Conditions

Goods should be stored at 0° to 25°C in a dry place. Store in the original package.

Installation Considerations

The product is packed with an easy-to understand instruction sheet & fixing elements. Assembly in 60 seconds. In order to attach and securely store a bike on a wall, a set comes with two pieces of 300x300mm hot, robust, galvanized steel pipe profiles with a 360mm total extension from the wall and a 35x310x3mm bracket with two fastening slots, two screws, two anchors, and two stoppers. Angle can be adjusted by widening the top screw.

Design Considerations

Wall mounting Bicycle Stands with steel profiles for storing and protecting bikes from theft. Suitable for OUTDOOR public spaces with capacity to store 1 bike in one single module.

Cleaning and Disinfecting

Clean your displays, with damp microfiber clothes, rinsed with simply water or warm, soapy or gentle shampooed water. Avoid using vinegar, abrasive, acidic, alcohol-based or heavy cleaners or cleaners containing Ammonia. Only after cleaning the product, if needed, simply apply disinfectant or sanitizer that is in compliance with your local guidelines and regulations.



T: +90 850 433 67 85 / info@mtdisplays.com / www.mtdisplays.com

INSTALLATION INSTRUCTIONS

Angled Bicycle Wall Stand / 1012826H000

Each product includes

- 1 x Bicycle wall stand
- 2 x Screw & anchor
- 2 x Stopper

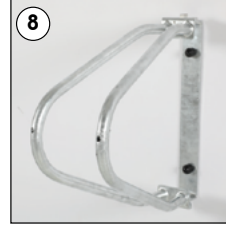
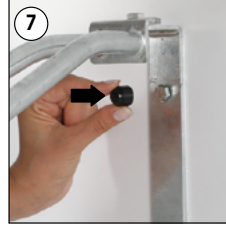
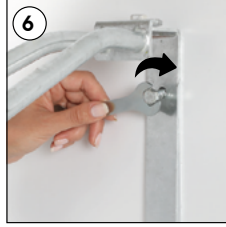
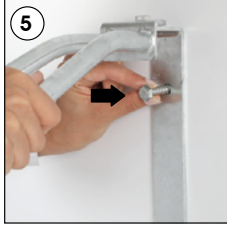
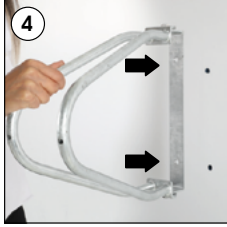
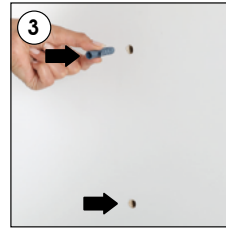
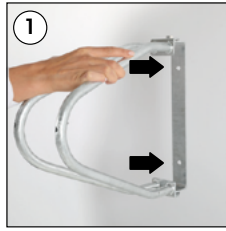

Adjusting the angle of the bike stand

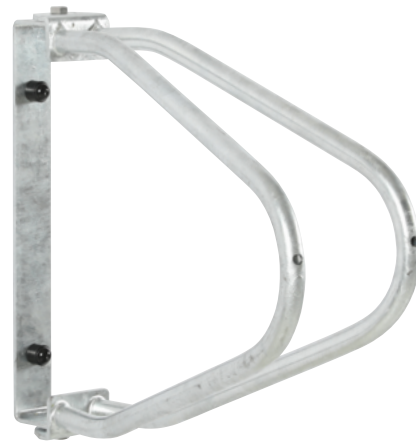
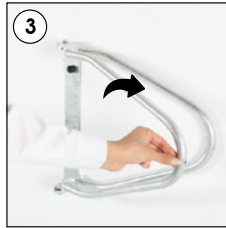
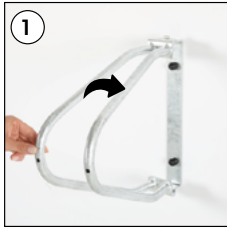
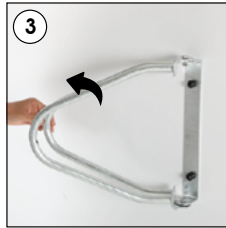
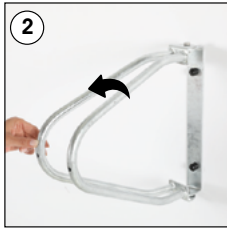
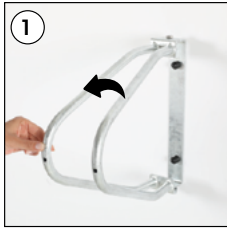
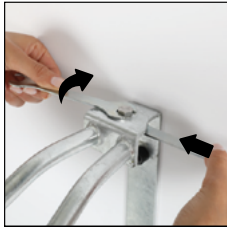

• Please inform the order number on the product or on the carton (e.g. 1/110001394-460) to the place that you have made the purchase if any problem with the product occurs.

• All rights reserved. All pictures, figures and writings are secured internationally by copy-right law. Infringements will be sued by civil and legal law.

This technical sheet's contents are all subject to update and modification at MT Displays' exclusive discretion. There is nothing official about this document. For final and legally binding information, please get in touch with the sales staff at MT Displays.



T: +90 850 433 67 85 / info@mtdisplays.com / www.mtdisplays.com