

ROUND BICYCLE STAND FINISH



PARKING AND GUARDING BIKES SAFELY ON THE GROUND

Round Bicycle Stand is suitable for ground surface use. It is made of hot sturdy galvanised steel. Round Bicycle Stand offers a perfect solution for storage. It is the best secure option for protecting your bike from theft. One module includes X2 440 X 330 bicycle stand profiles. One module has 700 mm width. Profiles can be interlocked each other for multiple use and there is no need for assembly for interlocking process. End caps are attached to the profiles.

KEY SELECTION ATTRIBUTES

- * Floor standing Bicycle Stands with steel profiles for storing and protecting bikes from theft.
- * Suitable for OUTDOOR public spaces with capacity to store 2 bikes in one single module.
- * One module set includes two hot sturdy galvanised steel profiles with 4 end caps and 700 mm length, two 440x330mm steel pipe profiles as bicycle stands for safely storing bicycles, 4 bolts and 4 washers for installation.

- * Galvanised steel in standard and various RAL colors available with antimicrobial powder coating.
- * The product is packed with an easy-to understand instruction sheet & fixing elements. Assembly in 60 seconds.

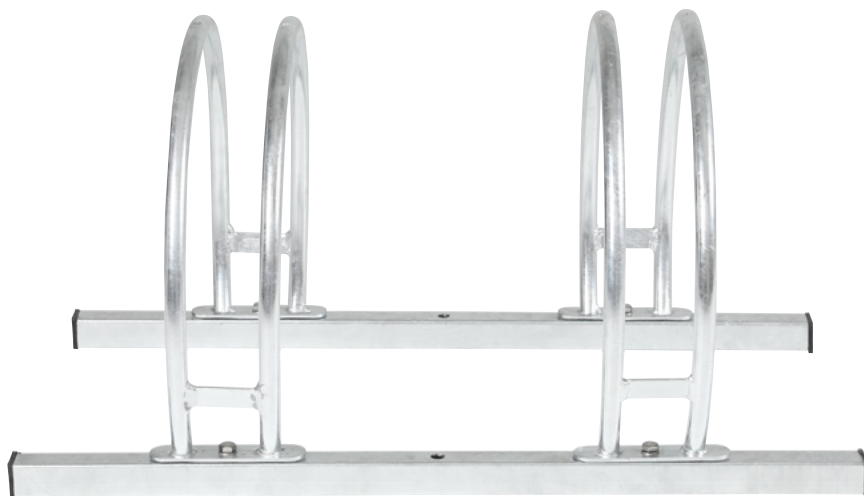

COLOURS IN STOCK



Silver

COLOUR OPTIONS

Black Anodised

White - RAL 9003

Red - RAL 3020

Green - RAL 6029

Silver Anodised

Black - RAL 9005

Blue - RAL 5002

Yellow - RAL 1021

SUITABLE FOR

Bicycle Stands can be used for INDOOR applications, for signage needs in many locations like shopping centers, markets, groceries, hotels, offices airports, shops and stores, hospitals, schools, apartments and many more.

WATCH VIDEO



Watch video at our website www.mtdisplays.com

FEATURES



EXPLODED VIEW

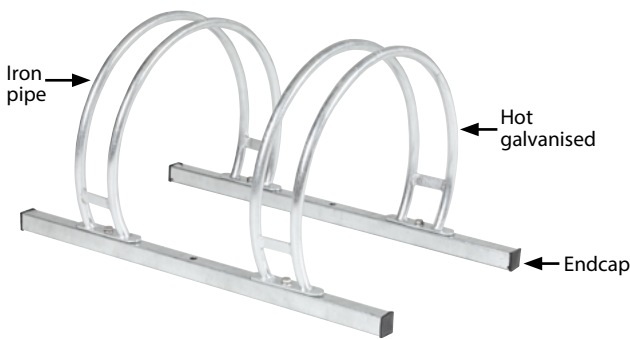

TECHNICAL DRAWING

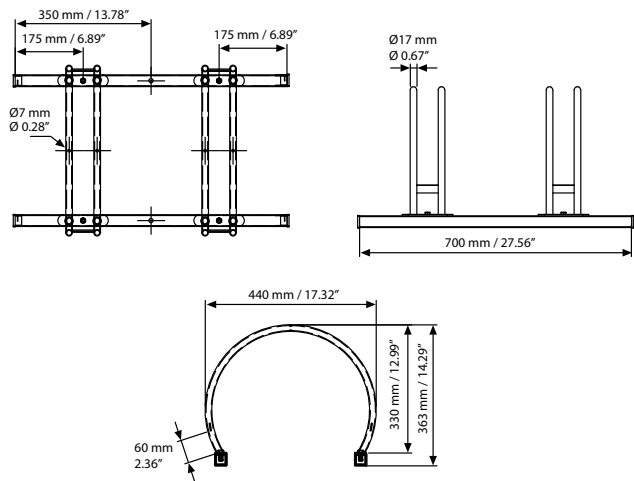

ARTICLES

ARTICLE	DESCRIPTION	WEIGHT	PACKING SIZE
		WITH PACKING	*W X H X D
UOBSR02000	Finish Hot Galvanised	6,150 kg	470 X 735 X 165 mm

PHYSICAL DATA

Material

Hot sturdy galvanised steel profiles and pipes.

Surface Finish

Galvanised steel in standard and various RAL colors available with antimicrobial powder coating. Call for custom color requests.

Recycled Content

Up to 78% recycled content used.

Warranty

All products are guaranteed for 3 years by MT Displays with below conditions:

[Warranty Conditions](#)

Storage Conditions

Goods should be stored at 0° to 25°C in a dry place. Store in the original package.

Installation Considerations

The product is packed with an easy-to understand instruction sheet & fixing elements. Assembly in 60 seconds. One module set includes two hot sturdy galvanised steel profiles with 4 end caps and 700 mm length, two 440x330mm steel pipe profiles as bicycle stands for safely storing bicycles, 4 bolts and 4 washers for installation.

Design Considerations

Floor standing Bicycle Stands with steel profiles for storing and protecting bikes from theft. Suitable for OUTDOOR public spaces with capacity to store 2 bikes in one single module.

Cleaning and Disinfecting

Clean your displays, with damp microfiber clothes, rinsed with simply water or warm, soapy or gentle shampooed water. Avoid using vinegar, abrasive, acidic, alcohol-based or heavy cleaners or cleaners containing Ammonia. Only after cleaning the product, if needed, simply apply disinfectant or sanitizer that is in compliance with your local guidelines and regulations.



T: +90 850 433 67 85 / info@mtdisplays.com / www.mtdisplays.com

INSTALLATION INSTRUCTIONS

Round Bicycle Stand Finish / 1012884H000

Each product includes

- 2 x Bicycle stand (440x330 mm)
- 2 x Bicycle stand profile
- 4 x Profile encap
- 4 x Bolt M8x20
- 4 x Washer Ø8

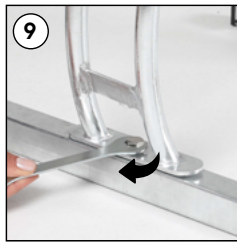
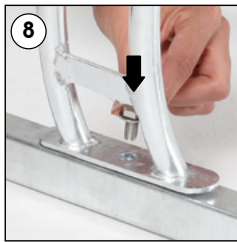
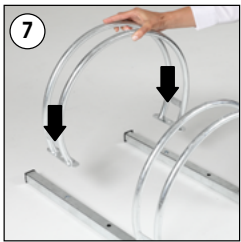
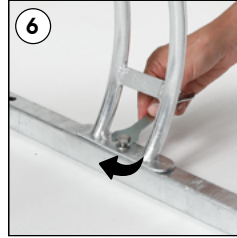
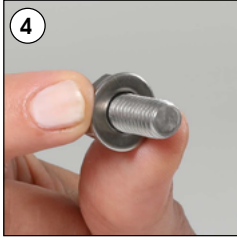
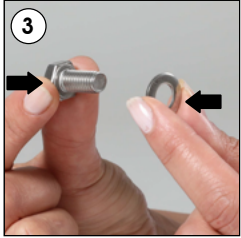
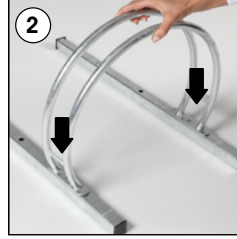
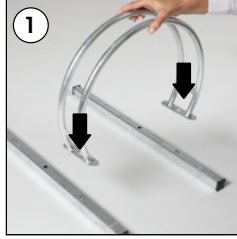

- Please inform the order number on the product or on the carton (e.g. 1/110001394-460) to the place that you have made the purchase if any problem with the product occurs.
- All rights reserved. All pictures, figures and writings are secured internationally by copy-right law. Infringements will be sued by civil and legal law.



This technical sheet's contents are all subject to update and modification at MT Displays' exclusive discretion. There is nothing official about this document. For final and legally binding information, please get in touch with the sales staff at MT Displays.



T: +90 850 433 67 85 / info@mtdisplays.com / www.mtdisplays.com