



DISPLAY PRODUCTS CATALOG 2024 - 2025



Index

Opti Frames

13-22

- Opti Frame® 0.55" / 14 mm
- Opti Frame® 1" / 25 mm
- Opti Frame® in Colors

Poster Frames

23-44

- Snap Frames
- Fire Resistant Snap Frames
- Window Frames
- Fancy Frames
- Double Sided Snap Frames
- Security Frames
- Lockable Snap Frames
- Magnetic Frames

Slide-in Frames

45-48

- Counter Slide-in Frames
- Single Sided Slide-in Frames
- Double Sided Slide-in Frames

Weatherproof Frames

49-52

- Lockable Weatherproof Frames
- Weatherproof Frame 1" / 25mm
- Weatherproof Frame 1.38" / 35mm

Poster Hangers

53-58

- Poster Snaps
- Banner Hangers
- Poster Fast
- Stretch Frames
- Poster Clamps
- Outdoor Flap Grippers

Showboards

59-62

- Poster Showboards
- Universal Poster Showboards

Banner Stands

63-72

- Cross Banners
- Quick Banners
- Newage Quick Banners
- Retractable Roll Up Stands
- Smart Roll Banners
- Easy Swaps
- Poster Traps
- Eco Roll Banners
- Super Eco Roll Banners

Printable Solutions

73-92

- Maxi Frames
- Maxi Frame with LED
- Star Maxi LED
- Power LED
- Maxi Frame Totem with LED
- Semi Products for Maxi Frame
- Omni Frame
- Omni A Board

Sign Holders

93-108

- Poster Stands
- Oval Based Floor Poster Stands
- Eco Floor Poster Stands
- Novel Display Stands
- Display Stands
- Display Stand Banner Sets
- Display Stand Slide-in Frames
- Poster Display Convex Boxes
- Totems
- Decorative Totems
- Mono Totems
- LEDA Illuminated Magnetic Totems

Literature Racks

109-132

- Free Standing Leaflet with Side Shelves
- Cocktail Brochure Sets
- Cocktail Brochure Sets for Wall
- Portable Leaflet Dispensers
- Multiside Brochure Sets
- Brochure Sets
- Decorative Brochure Stands
- Decorative Brochure Stands Plus
- Pillar Brochure Stands
- Zick-Zacks
- Double Leg Zick-Zacks
- Zic-Zack Lites
- Rapid Brochure Set
- Curved Reversible Tower Brochure Stand
- Twin Reversible Tower Brochure Stand
- Convex Reversible Tower Brochure Stand
- Double Sided Reversible Tower Brochure Stand
- Basic Reversible Tower Brochure Stand
- Reversible Tower Brochure Stand for Wall
- Newage Portable Zick-Zacks
- Portable Zick-Zacks
- Wood Zick-Zack
- Monoblocks

LED Signs

133-146

- Convex LEDbox
- Buy Max LEDbox NEW
- Best Buy LEDbox
- Smart LEDbox 25 mm
- Smart LEDbox 35 mm
- Lockable Weatherproof Smart LEDbox 35 mm
- Magneco LEDbox
- Acryled for Wall Mounting

Message Boards

147-154

- Frameboards
- Enclosed Bulletin Boards
- Premium Grade Enclosed Bulletin Boards

Floor Signs

155-172

- Flexible Sign Holders
- Flexible Sign Holder with LEDbox
- Arc Sign Holder
- Telescoping Sign Holders
- Floor Sign Holder
- Folder Sign Holder
- Restaurant Boards
- Curved Sign Holder
- Curved Sign Holder with Acryled
- Universal Showboard on Curved Post
- Paper Board Sign Holder
- Classical Sign Holder
- Decorative Sign Holder
- Adjustable Sign Holder

Sidewalk Signs

173-200

- A Board
- Eco A Board
- Premium A Board with logo
- Premium A Board with Profile logo
- Weatherproof A Board
- Slide-in A Board
- Easy Go A Board
- Wood Look A Board
- Street SignPro Board
- Street SignPro with Lens
- Street SignPro without Lens
- SwingPro&WindPro Plus
- SwingPro&WindPro Lite
- BannerPro
- Slide-in WindPro®
- Illuminated WindPro® with LED
- Eco Swingmaster
- Eco Waterbase Wind Sign
- Al Maki
- Rectangular Iron A Board
- Magnetic Iron A Board
- Waterbase Pavement Signs
- PS Boards

Wood Displays

201-220

- Wooden Frames
- Wood Slide-in Frame
- Wood A Board Indoor
- Wood A Board Outdoor
- Timber Chalk Board
- Wood Chalk Floor Stand
- Wood Dry Erase Floor Stand
- Nature Line Writing Board
- Wall Mount Wooden Card Holder
- Wood Magazine Rack for Wall
- Free Standing Wood Magazine Rack
- Counter Wood Chalk Frame
- Desktop Easel
- Petite Desktop Easel
- Wooden Roll Stand
- Wood Folding Luggage Rack
- Foldable Wood Box

Stanchions

221-228

- Q Belt
- Q Belt for Wall
- Retractable Stanchion Crowd Control Posts
- Crowd Control Stanchion Poles & Ropes
- Q Rope
- Street Barrier

Exhibition Displays

229-254

- Crown Truss NEW
- Pop-up with Magnetic
- Panset
- Panset Hexagonal Counter
- Panset Convex Counter
- Midsize Convex Counter
- Foldable Wood Counter NEW
- Pop-up Counter
- Promostand
- Seed Promostand
- Rectangular Promostand
- Circle Promostand
- Bean Promostand
- Tumble Box
- Puzzle Tumble Box
- Free Standing Puzzle Tumble Box

Office Products

255-276

- Door Signs
- Desktop Sign
- Wall Sign System
- Wall Sign Double Sided
- Sign Systems
- Fast Note
- Magnetic Glass Board
- Business Card Holder
- Coat Racks
- Waste Baskets
- 2 Step Plastic Stepstool

Presentation Systems

277-292

- White Boards
- Reference Racks
- Flipcharts
- Easels

Tablet & TV Stands

293-306

- Slim TV Stand
- Counter Tablet Holders
- Tablet Kiosk
- Boomerang Floor Tablet Stand
- Spider Floor Tablet Stand
- Red Spider Floor Tablet Stand

Brochure Holders&Leaflet Displays

307-330

- Photo Frame
- Cross Frame
- Leaflet Dispensers
- Multiple Pocket Leaflet Dispensers
- Wall Mount Leaflet Dispensers
- Clear Brochure Holder T Type
- Clear Brochure Holder T Type
- L Type with front Pocket
- Swing Wing
- Pet Pocket
- Foldable Leaflet Holder
- Upright Leaflet Holder
- Oval Leaflet Holder
- Duo Desktop Menu Holder
- Fort Desktop Menu Holder
- Curved Desktop Menu Holder
- Ticket Holder
- Card Holder 2 Sided
- Pyramid Card Holder
- Arc Menu Holder

Accessories

331-336

- Hangers
- Baskets
- Shelves
- Header Holder & Header
- Bags
- Levertool
- Separator
- Chalkboard Marker
- Lighting Components
- Panel
- Other

Semi Products

337-346

- Profiles
- Corners
- Connectors
- Springs
- End Caps
- Hangers
- Pipes
- Feet
- Counter Support
- Logo
- Shelf
- Panel
- Power Supply
- Base
- Others

Extrusion Lines

347-356

- PET lines
- Plastech PVC Foam Lines
- Neo Plastech PVC Foam Lines
- Plasteco PVC Foam Lines
- HIPS Lines

General Information

355

- Symbols
- RAL Charts

Presentation

MT Displays LLC, was founded in 2013 with more than 25 years of brand existence in US market. We serve the North American market with display products, printing facilities, showroom, and warehouses, based in Wilkes-Barre, PA.

Headquarters and Warehouses in US



Wilkes-Barre, PA: Our sales team, serves North American market with a large distribution office, showroom, and printing facilities. Established in 2013, the facilities of MT Displays LLC covers 126,000 square foot closed area and maintains a stock of 7,000 pallet capacity, 1,800 different SKUs and 424,500 pieces of stock units for short lead times and prompt responses to customer needs.

DisplaysMarket, our e-commerce website launched in 2013, serves online customers all over the USA, offering a wide range of unique products with a same day shipping system for orders placed until 2 pm.

Our Branches and Geographical Presence in the World

MT Displays Global, established in 1993, is a leading manufacturer in the display units sector. With 466,078 square foot of facilities, we offer 27 product groups and over 20,000 SKUs, all produced in-house. Headquartered in Turkiye with three production sites and a distribution branch in Budapest, Hungary, we serve partners in over 84 countries worldwide. Our commitment to innovation and quality has driven our success across six continents.

Branches and Warehouses Hungary



Budapest, Hungary: MT Displays KFT in Budapest was found in 2014 for serving Eastern Europe and Baltic countries with a comprehensive distribution branch, showroom, and a warehouse with 30,000 square foot closed area, maintaining a stock of 3,500 pallet capacity of finished products.

Headquarters and Factories Türkiye



Çayırova Kocaeli, Türkiye: Production facilities and warehouses with 172,000 square foot closed area, largest stock of raw materials, and 3,500 pallet capacity of finished products.

Branches and Warehouses Türkiye



Istanbul, Türkiye: MT Displays in Tuzla, Istanbul, includes our Printing Facilities with 7,000 square foot closed area, Manufacturing Facilities of LED products and a Warehouse with 96,900 square foot closed area, keeping a very large stock of finished products.



Gebze, Kocaeli, Türkiye: Modern facilities in Tavsanli, Gebze with automated production lines and warehouses with 41,000 square foot closed area, holding many pallet capacity of finished products.

Factory Management

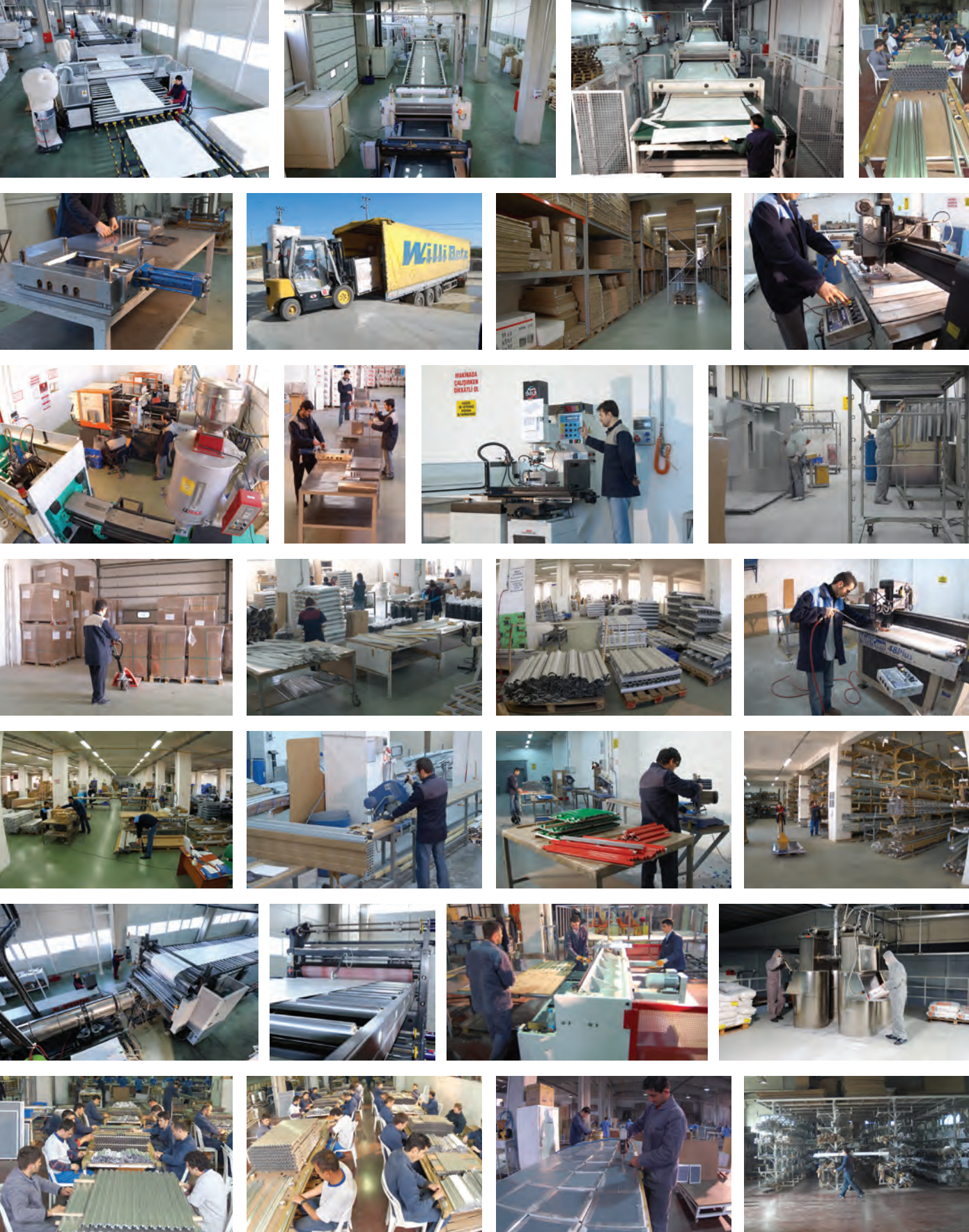

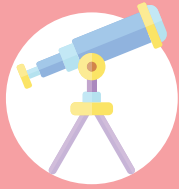

Our Vision

To strengthen and maintain our “**GLOBAL LEADER**” position in the world markets by constantly renewing ourselves, setting the standards, reshaping the markets with our innovative designs and custom solutions.



Our Mission

To maintain our position as a “**RELIABLE BUSINESS PARTNER**” for our customers by providing fast services, technical consultancy and marketing tools support as well as producing innovative and distinctive solutions for them.

The success of our firm is generated from well-organized skilled professionals, investment in equipment and manpower, and flexible production that fully meets the needs of our dealers. Combined with our principle to respond with a proactive approach, superlative quality, and long years of experience in providing effective solutions, we achieve desirable results for outdoor and indoor displays.

The uniqueness of MT Displays comes from our ability to create innovative design solutions to fulfill evolving demands via an agile approach in the global markets and the use of high technology and automated production lines for mass production. Many of our ingenious designs result in design protection and patents. Today, MT Displays has around **30 patent-protected products** and **3 international trademarks registered with WIPO**. This power enables us to lead the market and shape trends over the last **31 years**. Currently, we are proud of our Roto-molding Automated Assembly Lines,” “Plastic Sheet Extrusion Lines” and “Fully Automatic Blow Molding Production Lines.” Referring to these achievements, we ensure the creation of more innovative solutions for shaping the future of our industry.

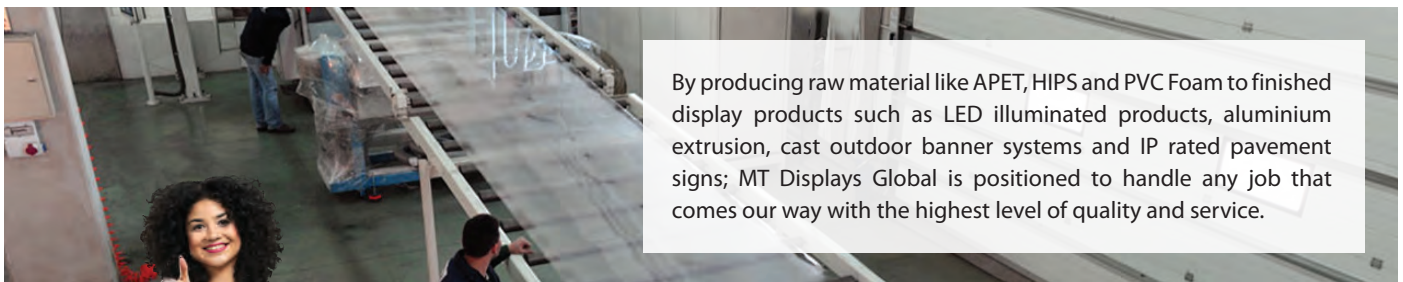
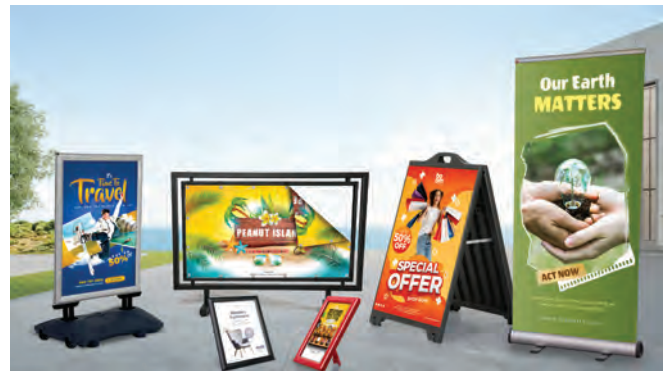

By producing raw material like APET, HIPS and PVC Foam to finished display products such as LED illuminated products, aluminium extrusion, cast outdoor banner systems and IP rated pavement signs; MT Displays Global is positioned to handle any job that comes our way with the highest level of quality and service.



Strengths:

- **In-House Design:** Our cutting-edge designs are made to your specifications with the highest level of sophistication.
- **Production Capacity:** Our large and flexible production lines ensure orders are produced with quick lead times and the highest efficiency.
- **Intense Quality Control:** In-house production; from raw materials to finished products, enable us to keep the highest quality standards in the industry.
- **Patent Power:** Dozens of engineers and designers are constantly working to create new and inventive concepts. Our target is to remain the market leader with an ever increasing line of original and ingenious products. All unique designs and production techniques are protected by patents.



Marketing Support

Displays supports its distributors in two different kinds of tools

HOW WE SUPPORT YOU?

DIY tools

Marketing tools

DIY TOOLS

1

Unbranded webpages for distributors



opti-frame.com
No name page and to be linked



displayshowroom.com
Product in place (PIP)



displayacademy.com
No name page and to be linked

Webpages



mtdisplays.com
detailed product info, manuals, technical details, downloads, videos available

Product news letters

Customized for distributor

DIY TOOLS

2

Crown Truss

crown3d.net
3D design programme for dealers and resellers



DIY TOOLS

3

Youtube movies

Product movies for download and customization



Custom Service Center(CSC)

Close follow up for enquiries and order placing

Product Specific Webpages

opti-frame.com



omni-frame.com



Alternative product offerings

Materials for webshops

We provide to online websites with comprehensive product information, including videos, images, box dimensions, weights, and text descriptions.

MARKETING TOOLS

1



Product Training

At distributors or at MT displays premises including factory visit

Product Introduction kits

Such as Maxi Frame Presentation Box, Wall Sign Sample Box, Crown Truss Sample Kits, Omni Frame Kit and more

Showroom kits

Bronze, Silver and Golden showroom kits



Promotion Bag

For new customers miniature samples to understand the whole range.



MARKETING TOOLS

2



Open House at distributor's showroom

Product Gallery

Movies, detailed pictures, PIP pictures, assembly sheets



Licensed products

Catalogues

Global catalogue:
Yearly updated as a technical manual



Jet Catalogue:
Available for branded for distributor who would use for marketing purposes



Digest catalogue:
Available for branded for exhibitions



MARKETING TOOLS

3



Team participations in exhibitions

Product support for exhibitions

A Board with Frame Samples or booth set up with Crown Truss System as well as sample support



Product analysis

Alternative or competitor product analysis

MT Displays' Sustainability Commitment

At MT Displays, sustainability isn't just a goal – it's our guiding principle.

We have already announced our latest Sustainability Commitment Report for the Year 2024. In this report, we highlight our roadmap integrating a range of strategies and efforts towards a greener future, focusing on reduction of CO2 emissions, renewable energy, environmental initiatives, and community engagement, in line with Sustainable Development Goals of United Nations.

MT Displays holds certifications that reflect our adherence to international environmental standards and regulations, including **REACH, RoHS, FCC, Prop 65, CE, UKCA, UL, ISO 9001, and ISO 27001**. These certifications demonstrate our commitment to adhering to stringent environmental regulations and ensuring our products meet the highest standards for safety and sustainability.



We are committed to reporting our corporate carbon footprint to authorized institutions by implementing standards by the end of 2024. In 2024, we have received **ISO 14001, 45001, and 50001** certifications. This proactive approach aligns with preparations to comply with the Carbon Border Adjustment Regulation, preventing additional costs for business partners and promoting environmentally responsible.



From achieving **I-REC** International Renewable Energy Certification, saving on water usage, eliminating energy consumption, sustainable wood sourcing, waste management, spare part program for self-repairing to implementing eco-friendly packaging solutions, our commitment to sustainability shines through in every aspect of our operations. We're proud to share our progress and invite you to join us in our mission to create a better world for generations to come.

Access Our Full Sustainability Commitment Report



Interested in learning more about our sustainability efforts?

Explore our initiatives in detail, from renewable energy projects to social responsibility initiatives, and discover how we're making a positive impact on the environment and our communities. Thank you for your continued support as we work towards a more sustainable future together. Access the full report from this link:



[MT Displays' Sustainability Report Q1, 2024](#)
Download



Antimicrobial Powder Coating Option



**Improve Sanitation
with Antimicrobial Technologies**



Powder Coating with Silver Ions
Antimicrobial Test Certificate, ISO 22196:2011, JIS Z 2801



Our colored products can be coated with a special Antimicrobial Powder Coating including Silver Ion Additives.

Maintain with us! Antimicrobial Product Solutions!

As it maintains its antibacterial feature over the expected life of the product, this special coating makes our life more healthy and practical. In terms of sustainability, it is more easy to clean our antimicrobial powder coated products with a mild detergent or water.

Some of the Commercial Areas where antimicrobial surfaces can be used!

Offices, hospitals, public transport, restaurants, shopping malls, sports centers, banks, supermarkets, laboratories, hotels, schools, airports, fitness centers, entertainment venues, libraries, museums, government buildings, and healthcare facilities. Implementing antimicrobial surfaces in these environments can significantly reduce the spread of harmful bacteria and viruses, ensuring a safer and healthier space for employees, customers, and the general public. These surfaces are particularly beneficial in high-traffic areas where maintaining hygiene is crucial, helping to prevent infections and promote overall well-being.





Opti Frames®

- Opti Frame® 0.55" / 14 mm
 - 0.55" / 14 mm Silver Anodized
 - 0.55" / 14 mm Black
 - 0.55" / 14 mm Wood Effect
- Opti Frame® 1" / 25 mm
 - 1" / 25 mm Silver Anodized
 - 1" / 25 mm Black
 - 1" / 25 mm Wood Effect
- Opti Frame® in Colors



With our new product, we aim to bring a new dimension of performance to retail display frames.

Our R&D team has focused their extensive knowledge on transforming production processes to create a completely new type of front loading display frame.

Opti Frame not only delivers multi functional applications with a variety of mounting options, but is specifically engineered to offer very competitive pricing in response to the demands of the competitive snap frame market.

The product is protected worldwide by relevant patent applications.

Our Opti Frame family progressively welcomes new additions in sizes.

Opti Frame can be used for signage needs in many locations: Offices, hotels, hospitals, schools, airports, stores, apartments and many more..

Profile Type

0.55" - 14 mm



1" - 25 mm

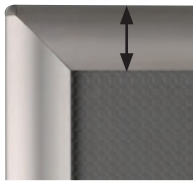

Frame Color



Silver



Black



Wood Effect

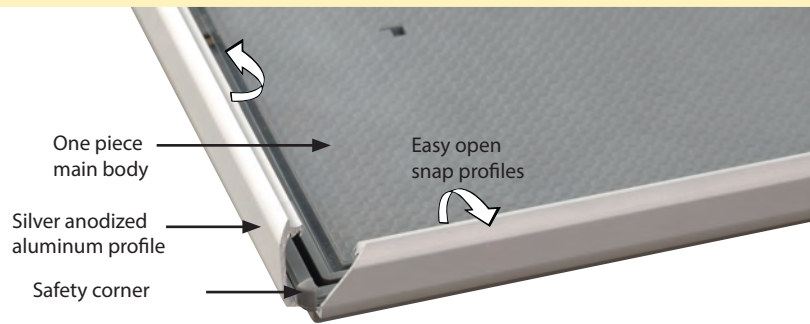

Smart design with distinctive features... "no sharp edges"

Optimized use! Goes on counters, goes on walls...

Multi functional use

Low cost snap frames with advanced design

| Poster Size | PROFILE OPTIONS | | |
|-------------|----------------------|-------------------|-----------------|
| | 0.55" Profile Safety | 1" Profile Safety | Counter Support |
| 5"X7" | ✓ | x | ✓ |
| 8"X10" | ✓ | x | ✓ |
| 8.5"X11" | x | ✓ | ✓ |
| 11"X17" | x | ✓ | x |
| 22"X28" | x | ✓ | x |

Opti Frame can be used for signage needs in many locations: Offices, hotels, hospitals, schools, airports, stores, apartments and many more...

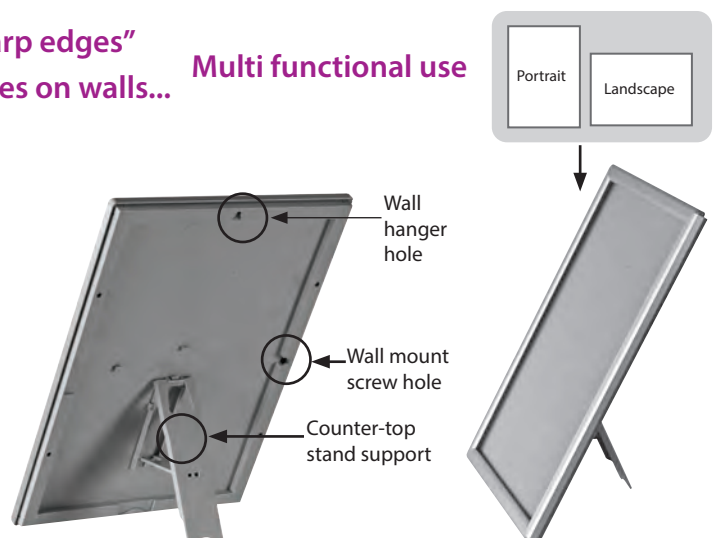

Opti Frames®



See movie at our website www.mtdisplays.com.tr

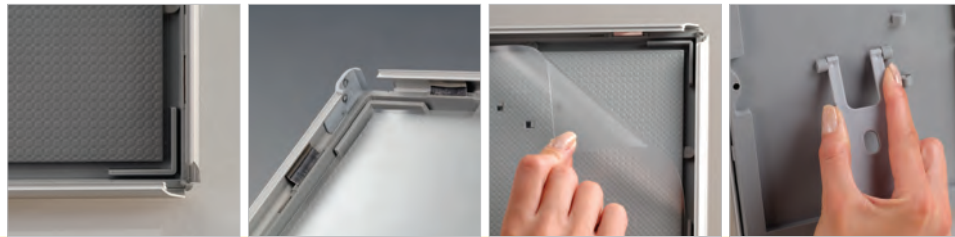

0.55" / 14 mm Profile, 45°

- Gray color backing and counter support.
- The front profiles are silver anodized.
- Eco-friendly.
- The product is protected worldwide by all relevant patent applications.
- Anti-glare poster cover sheet.

Opti Frame comes ready for wall mounting with 2 holes on both long sides. Wall hanging is also available with wall hanger holes placed on short and long sides.

Optional counter support offers a new counter stand position available standard in each unit in portrait and landscape position. Safety corners ensure maximum safety in public areas.

Suitable for silk screen printing, max. letter height is 0.28" mm.

Patent: PCT/TR06/000018 - WO 2007/126397 - EP 2016574 - DE 20 2006 020 145 - US 2009/211134 - AU 2006342800 - CN 101473363 - CA 2654307 - UA 2008 13893 - EA 200802174/26 - IN WO 2007/126397 - ZA 2008/09638 - TR 2007 05704 - OHIM 831235-0001,2,3,4



Multi functional use

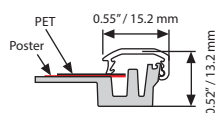
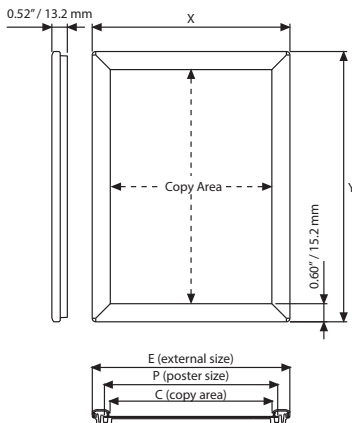
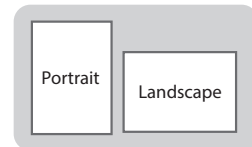

| MATERIAL : Silver anodized aluminum PROFILE : 0.55" / 45° | | | | | WEIGHT | PACKING SIZE |
|---|----------------|----------|---------------|-----------------|--------------|-------------------------|
| ARTICLE | EXTERNAL (x-y) | POSTER | COPY | DESCRIPTION | WITH PACKING | *W X H X D |
| UCP145N057 | 5.83" X 7.83" | 5" X 7" | 4.61" X 6.61" | Without support | 0.396 lbs | 6.69" X 8.66" X 0.94" |
| UCP145N157 | 5.83" X 7.83" | 5" X 7" | 4.61" X 6.61" | With support | 0.396 lbs | 6.69" X 8.66" X 0.94" |
| UCP145N000 | 8.82" X 10.83" | 8" X 10" | 7.60" X 8.82" | Without support | 0.661 lbs | 10.24" X 12.20" X 0.94" |
| UCP145N100 | 8.82" X 10.83" | 8" X 10" | 7.60" X 8.82" | With support | 0.661 lbs | 10.24" X 12.20" X 0.94" |

*W:Width H: Height D: Depth



Opti Frames®



See movie at our website www.mtdisplays.com.tr



0.55" / 14 mm Profile, 45° - Black

- Black color backing and counter support.
- The front profiles have black powder coating RAL 9005.
- Eco-friendly.
- The product is protected worldwide by all relevant patent applications.
- Anti-glare poster cover sheet.



Opti Frame comes ready for wall mounting with 2 holes on both long sides. Wall hanging is also available with wall hanger holes placed on short and long sides.



Optional counter support offers a new counter stand position available standard in each unit in portrait and landscape position. Safety corners ensure maximum safety in public areas.



Suitable for silk screen printing, max. letter height is 0.28" mm.

Patent: PCT/TR06/000018 - WO 2007/126397 - EP 2016574 - DE 20 2006 020 145 - US 2009/211134 - AU 2006342800 - CN 101473363 - CA 2654307 - UA 2008 13893 - EA 200802174/26 - IN WO 2007/126397 - ZA 2008/09638 - TR 2007 05704 - OHIM 831235-0001,2,3,4



Multi functional use

Portrait

Landscape

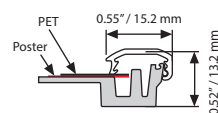
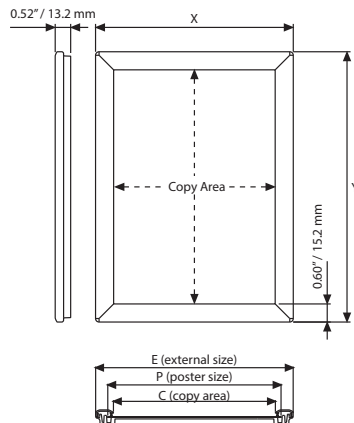

| MATERIAL : Black powder coated RAL 9005 PROFILE : 0.55" / 45° | | | | | WEIGHT | PACKING SIZE |
|---|----------------|----------|---------------|-----------------|--------------|------------------------|
| ARTICLE | EXTERNAL (x-y) | POSTER | COPY | DESCRIPTION | WITH PACKING | *W X H X D |
| UCP145B057 | 5.83" X 7.83" | 5" X 7" | 4.61" X 6.61" | Without support | 0.396 lbs | 6.69" X 8.66" X 0.94" |
| UCP145B157 | 5.83" X 7.83" | 5" X 7" | 4.61" X 6.61" | With support | 0.396 lbs | 6.69" X 8.66" X 0.94" |
| UCP145B000 | 8.82" X 10.83" | 8" X 10" | 7.60" X 8.82" | Without support | 0.661 lbs | 9.84" X 12.60" X 0.94" |
| UCP145B100 | 8.82" X 10.83" | 8" X 10" | 7.60" X 8.82" | With support | 0.661 lbs | 9.84" X 12.60" X 0.94" |

*W:Width H:Height D:Depth



Opti Frames®



See movie at our website www.mtdisplays.com.tr



0.55" / 14 mm Profile, 45° - Wood Effect

- Wooden color backing and counter support.
- The front profiles have a wood effect finish.
- Eco-friendly.
- The product is protected worldwide by all relevant patent applications.
- Anti-glare poster cover sheet.



Opti Frame comes ready for wall mounting with 2 holes on both long sides. Wall hanging is also available with wall hanger holes placed on short and long sides.



Optional counter support offers a new counter stand position available standard in each unit in portrait and landscape position. Safety corners ensure maximum safety in public areas.



Suitable for silk screen printing, max. letter height is 0.28" mm.

Patent: PCT/TR06/000018 - WO 2007/126397 - EP 2016574 - DE 20 2006 020 145 - US 2009/211134 - AU 2006342800 - CN 101473363 - CA 2654307 - UA 2008 13893 - EA 200802174/26 - IN WO 2007/126397 - ZA 2008/09638 - TR 2007 05704 - OHIM 831235-0001,2,3,4



Multi functional use

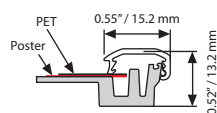
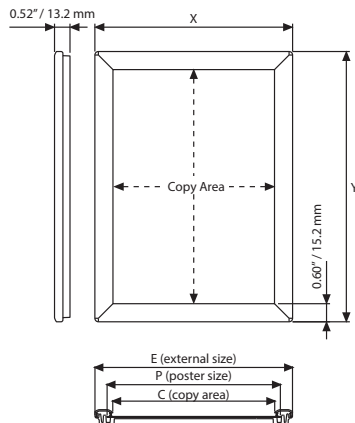
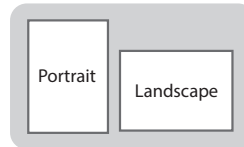

| MATERIAL : Wood Look Effect PROFILE : 0.55" / 45° | | | | WEIGHT | PACKING SIZE |
|---|----------------|----------|---------------|--------------|------------------------|
| ARTICLE | EXTERNAL (x-y) | POSTER | COPY | WITH PACKING | *W X H X D |
| UCP145W057 | 5.83" X 7.83" | 5" X 7" | 4.61" X 6.61" | 0.396 lbs | 6.69" X 8.66" X 0.94" |
| UCP145W157 | 5.83" X 7.83" | 5" X 7" | 4.61" X 6.61" | 0.396 lbs | 6.69" X 8.66" X 0.94" |
| UCP145W000 | 8.82" X 10.83" | 8" X 10" | 7.60" X 8.82" | 0.661 lbs | 9.84" X 12.60" X 0.94" |
| UCP145W100 | 8.82" X 10.83" | 8" X 10" | 7.60" X 8.82" | 0.661 lbs | 9.84" X 12.60" X 0.94" |

*W:Width H: Height D: Depth



Opti Frames®



See movie at our website www.mtdisplays.com.tr



1" / 25 mm Profile, 45°

- Gray color backing and counter support.
- The front profiles are silver anodized.
- Eco-friendly.
- The product is protected worldwide by all required patent applications.
- Anti-glare poster cover sheet.

Opti Frame comes ready for wall mounting with 2 holes on both long sides. Wall hanging is also available with wall hanger holes placed on short and long sides.

Optional counter support offers a new counter stand position available standard in each unit in portrait and landscape position. Safety corners ensure maximum safety in public areas.

Suitable for silk screen printing, max. letter height is 0.59".

Patent: PCT/TR06/000018 - WO 2007/126397 - EP 2016574 - DE 20 2006 020 145 - US 2009/211134 - AU 2006342800 - CN 101473363 - CA 2654307 - UA 2008 13893 - EA 200802174/26 - IN WO 2007/126397 - ZA 2008/09638 - TR 2007 05704 - OHIM 831235-0001,2,3,4



Multi functional use

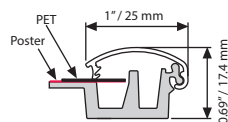
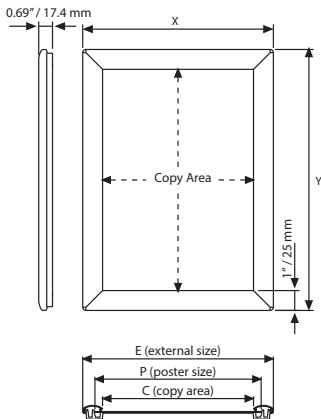
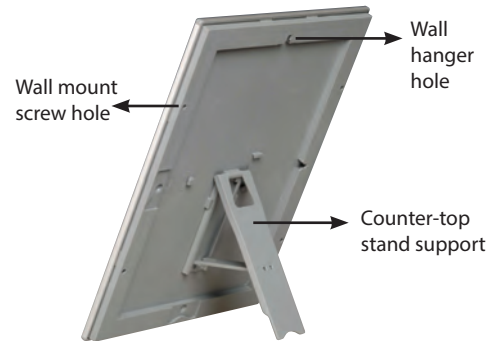
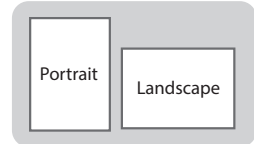

| MATERIAL : Silver anodized aluminum PROFILE : 1" / 45° | | | | | WEIGHT | PACKING SIZE |
|--|-----------------|------------|-----------------|-----------------|--------------|-------------------------|
| ARTICLE | EXTERNAL (x-y) | POSTER | COPY | DESCRIPTION | WITH PACKING | *W X H X D |
| UCP255N081 | 9.72" X 12.22" | 8.5" X 11" | 7.75" X 10.25" | Without support | 0.981 lbs | 10.63" X 13.39" X 0.94" |
| UCP255N181 | 9.72" X 12.22" | 8.5" X 11" | 7.75" X 10.25" | With support | 0.981 lbs | 10.63" X 13.39" X 0.94" |
| UCP255N017 | 12.22" X 18.22" | 11" X 17" | 9.78" X 15.78" | Without support | 1.873 lbs | 12.99" X 18.90" X 0.94" |
| UCP255N022 | 23.22" X 29.22" | 22" X 28" | 21.25" X 27.25" | Without support | 4.034 lbs | 23.62" X 29.53" X 0.94" |

* W:Width H: Height D: Depth



Opti Frames®



See movie at our website www.mtdisplays.com.tr



1" / 25 mm Profile, 45° - Black

- Black color backing and counter support.
- The front profiles have black powder coating RAL 9005.
- Eco-friendly.
- The product is protected worldwide by all relevant patent applications.
- Anti-glare poster cover sheet.

Opti Frame comes ready for wall mounting with 2 holes on both long sides. Wall hanging is also available with wall hanger holes placed on short and long sides.

Optional counter support offers a new counter stand position available standard in each unit in portrait and landscape position. Safety corners ensure maximum safety in public areas.

Suitable for silk screen printing, max. letter height is 0.59".

Patent: PCT/TR06/000018 - WO 2007/126397 - EP 2016574 - DE 20 2006 020 145 - US 2009/211134 - AU 2006342800 - CN 101473363 - CA 2654307 - UA 2008 13893 - EA 200802174/26 - IN WO 2007/126397 - ZA 2008/09638 - TR 2007 05704 - OHIM 831235-0001,2,3,4



Multi functional use

Portrait

Landscape

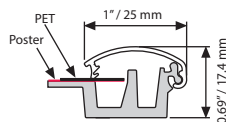
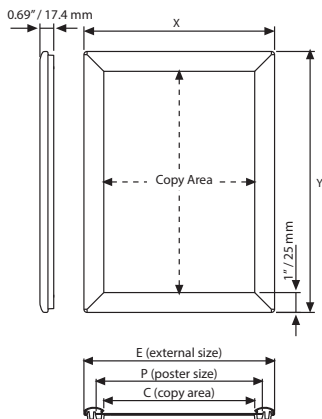

| MATERIAL : Black powder coated RAL 9005 PROFILE : 1" / 45° | | | | | WEIGHT | PACKING SIZE |
|--|-----------------|------------|-----------------|-----------------|--------------|-------------------------|
| ARTICLE | EXTERNAL (x-y) | POSTER | COPY | DESCRIPTION | WITH PACKING | *W X H X D |
| UCP2558081 | 9.72" X 12.22" | 8.5" X 11" | 7.75" X 10.25" | Without support | 0.981 lbs | 10.63" X 13.39" X 0.94" |
| UCP2558181 | 9.72" X 12.22" | 8.5" X 11" | 7.75" X 10.25" | With support | 0.981 lbs | 10.63" X 13.39" X 0.94" |
| UCP2558017 | 12.22" X 18.22" | 11" X 17" | 9.78" X 15.78" | Without support | 1.873 lbs | 12.99" X 18.90" X 0.94" |
| UCP2558022 | 23.22" X 29.22" | 22" X 28" | 21.25" X 27.25" | Without support | 4.034 lbs | 23.62" X 29.53" X 0.94" |

*W:Width H: Height D: Depth



Opti Frames®



See movie at our website www.mtdisplays.com.tr

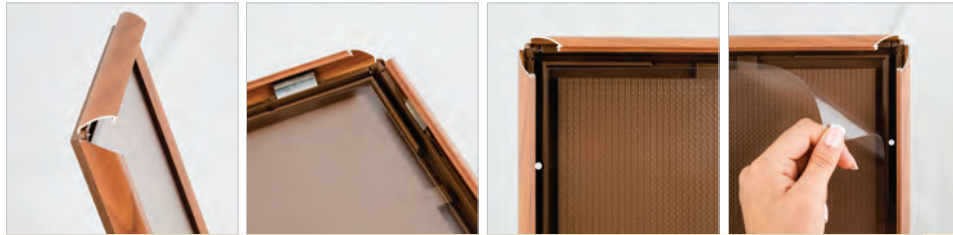

1" / 25 mm Profile, 45° - Wood Effect

- Wooden color backing and counter support.
- The front profiles have a Wood Effect Finish.
- Eco-friendly.
- The product is protected worldwide by all required patent applications.
- Anti-glare poster cover sheet.



Opti Frame comes ready for wall mounting with 2 holes on both long sides. Wall hanging is also available with wall hanger holes placed on short and long sides.



Optional counter support offers a new counter stand position available standard in each unit in portrait and landscape position. Safety corners ensure maximum safety in public areas.

Patent: PCT/TR06/000018 - WO 2007/126397 - EP 2016574 - DE 20 2006 020 145 - US 2009/211134 - AU 2006342800 - CN 101473363 - CA 2654307 - UA 2008 13893 - EA 200802174/26 - IN WO 2007/126397 - ZA 2008/09638 - TR 2007 05704 - OHIM 831235-0001,2,3,4

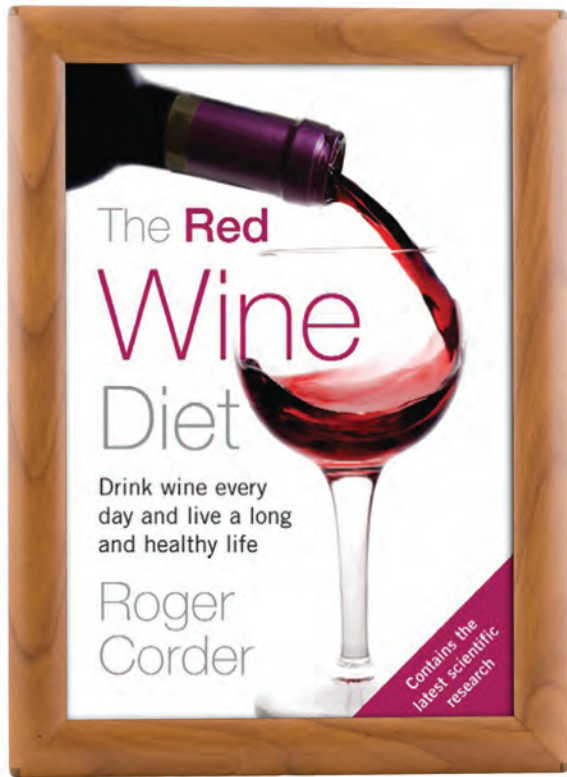

Multi functional use

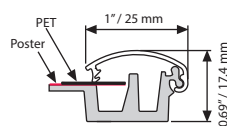
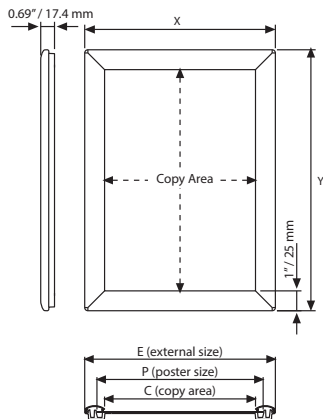
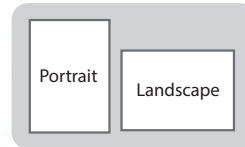

| MATERIAL : Wood Look Effect PROFILE : 1" / 45° | | | | | WEIGHT | PACKING SIZE |
|--|----------------|------------|----------------|--------------|--------------|-------------------------|
| ARTICLE | EXTERNAL (x-y) | POSTER | COPY | DESCRIPTION | WITH PACKING | *W X H X D |
| UCP255W181 | 9.72" X 12.22" | 8.5" X 11" | 7.75" X 10.25" | With support | 0.981 lbs | 10.63" X 13.39" X 0.94" |

*W:Width H: Height D: Depth



Opti Frame® Now in Colors

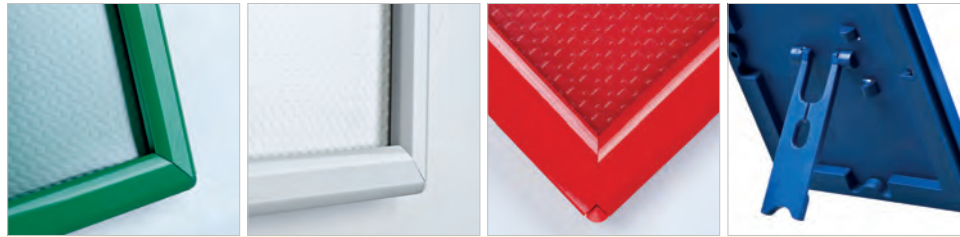

Spring colors in Opti Frame
Multi-functional Opti Frame is now available in colors.
New colors in different sizes. No minimum order quantity. Fits well in all environments.



6 Colors



Stands on counter

Opti®
Frame
www.opti-frame.com

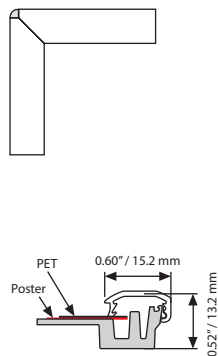
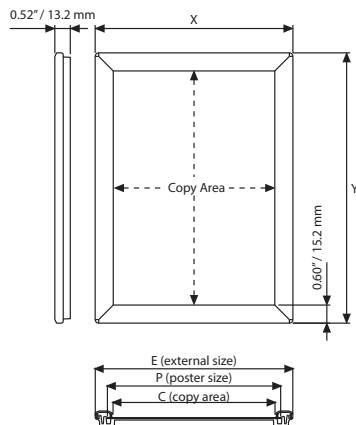

| MATERIAL : RAL powder coated PROFILE : 0.55" / 45° | | | | | WEIGHT | PACKING SIZE |
|--|----------------|---------|---------------|-------------------|--------------|-----------------------|
| ARTICLE | EXTERNAL (x-y) | POSTER | COPY | DESCRIPTION | WITH PACKING | *W X H X D |
| UCP145B157 | 5.83" X 7.83" | 5" X 7" | 4.61" X 6.61" | RAL 9005 - Black | 0.396 lbs | 6.69" X 8.66" X 0.94" |
| UCP145E157 | 5.83" X 7.83" | 5" X 7" | 4.61" X 6.61" | RAL 6029 - Green | 0.396 lbs | 6.69" X 8.66" X 0.94" |
| UCP145H157 | 5.83" X 7.83" | 5" X 7" | 4.61" X 6.61" | RAL 9003 - White | 0.396 lbs | 6.69" X 8.66" X 0.94" |
| UCP145L157 | 5.83" X 7.83" | 5" X 7" | 4.61" X 6.61" | RAL 5002 - Blue | 0.396 lbs | 6.69" X 8.66" X 0.94" |
| UCP145Y157 | 5.83" X 7.83" | 5" X 7" | 4.61" X 6.61" | RAL 1021 - Yellow | 0.396 lbs | 6.69" X 8.66" X 0.94" |
| UCP145R157 | 5.83" X 7.83" | 5" X 7" | 4.61" X 6.61" | RAL 3020 - Red | 0.396 lbs | 6.69" X 8.66" X 0.94" |



* W:Width H: Height D: Depth



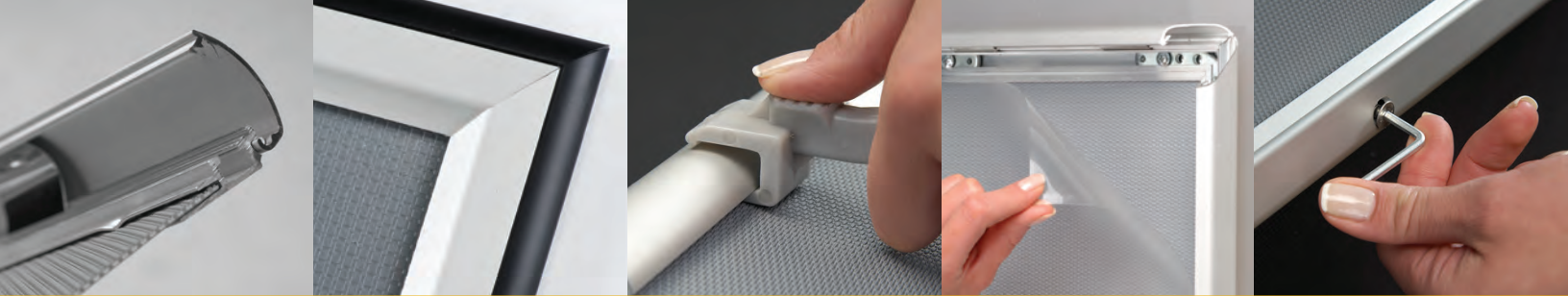

Poster Frames

- Snap Frames
 - 0.59" / 15 mm
 - 0.78" / 20 mm
 - 1" / 25 mm
 - 1" / 25 mm Gold Look
 - 1" / 25 mm Chrome Look
 - 1" / 25 mm Stainless Steel Look
 - 1" / 25 mm Black Anodized
 - 1" / 25 mm Wood Look Effect
 - 1" / 25 mm Coloured Snap Frame
- Fancy Frames
 - 1.18" / 30 mm
 - 1.25" / 32 mm
 - 1.25" / 32 mm with Safe Corners
 - 1.77" / 45 mm
 - 1.81" / 46 mm
- Fire Resistant Snap Frames
- Window Frames
 - 1" / 25 mm
- Double Sided Snap Frames
- Security Frames
 - 1" / 25 mm
 - 1.65" / 42 mm
- Lockable Snap Frames
- Magnetic Frames

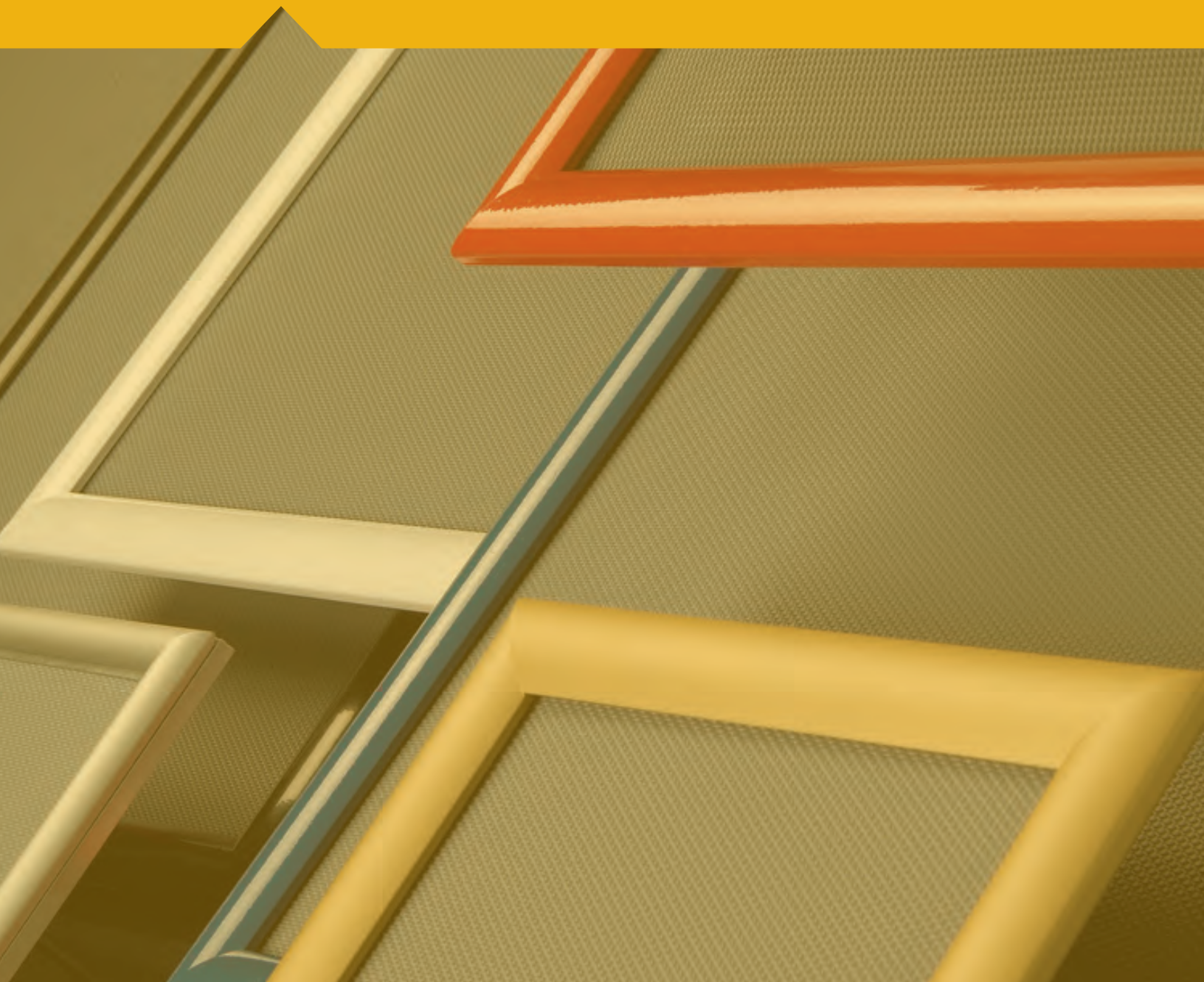

Snap Frames

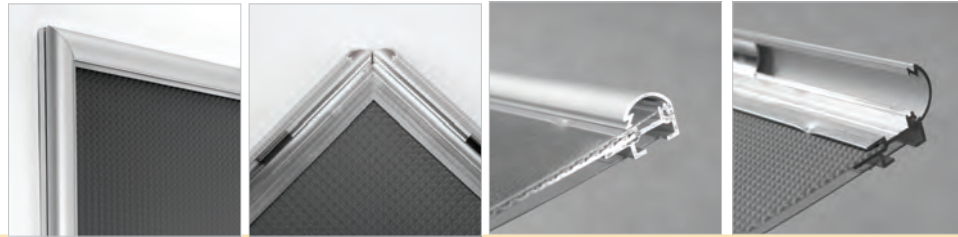

- 0.59" / 15 mm Profile, 45°**
- Ideal for small-sized posters.
 - Natural silver anodized and black colors available.
 - Mitered corners.
 - Anti-glare poster cover sheet.

Each frame includes wall mounting accessories (4 screws & 4 plugs).

! Suitable for silk screen printing, max. letter height is 0,31.

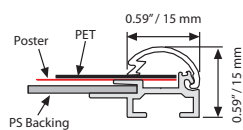
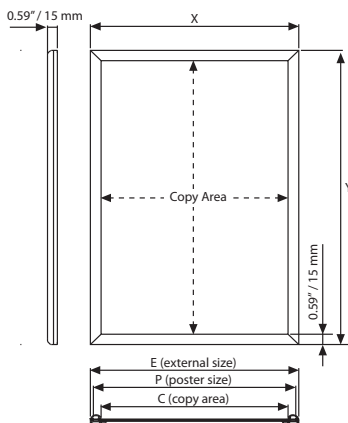

| MATERIAL : Silver anodized aluminum | | | | | WEIGHT | PACKING SIZE |
|-------------------------------------|-------------|-----------------|------------|-----------------|--------------|-------------------------|
| ARTICLE | DESCRIPTION | EXTERNAL (x-y) | POSTER | COPY | WITH PACKING | *W X H X D |
| UCN155N081 | Silver | 8.90" X 11.38" | 8.5" X 11" | 7.72" X 10.20" | 1.102 lbs | 10.63" X 12.99" X 0.83" |
| UCN155N017 | Silver | 11.38" X 17.40" | 11" X 17" | 10.20" X 16.22" | 1.873 lbs | 12.99" X 18.90" X 0.83" |
| UCN155N014 | Silver | 14.41" X 22.40" | 14" X 22" | 13.23" X 21.22" | 2.711 lbs | 16.54" X 24.41" X 0.83" |
| UCN155N016 | Silver | 16.42" X 20.39" | 16" X 20" | 15.24" X 19.21" | 2.425 lbs | 18.50" X 22.44" X 0.83" |
| UCN155N012 | Silver | 17.40" X 22.40" | 17" X 22" | 16.22" X 21.22" | 2.711 lbs | 18.50" X 22.44" X 0.83" |
| UCN155N018 | Silver | 18.43" X 24.41" | 18" X 24" | 17.24" X 23.23" | 2.645 lbs | 20.08" X 25.98" X 0.83" |
| UCN155N023 | Silver | 20.39" X 30.39" | 20" X 30" | 19.21" X 29.21" | 3.637 lbs | 22.44" X 32.28" X 0.91" |
| UCN155B081 | Black | 8.90" X 11.38" | 8.5" X 11" | 7.72" X 10.20" | 1.102 lbs | 10.63" X 12.99" X 0.83" |
| UCN155B017 | Black | 11.38" X 17.40" | 11" X 17" | 10.20" X 16.22" | 1.873 lbs | 12.99" X 18.90" X 0.83" |

* W:Width H: Height D: Depth





Snap Frames



- 0.79" / 20 mm Profile, 45°**
- Ideal for small-sized posters.
 - Natural silver anodized and black colors available.
 - Mitered corners.
 - Anti-glare poster cover sheet.

 Each frame includes wall mounting accessories (4 screws & 4 plugs).

 "Optional hangers" permit easy mounting.

 Suitable for silk screen printing, max. letter height is 0.43.



UYUP057000
Counter support
available. Suitable for
both landscape&portrait.



UYAA011010
V hanger

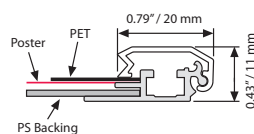
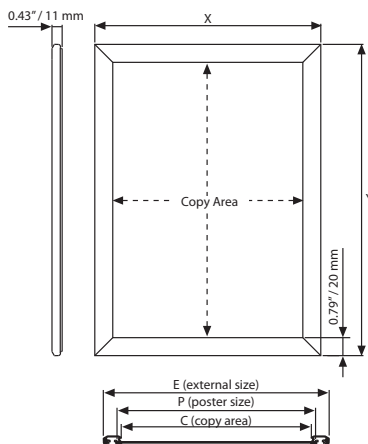

| MATERIAL : Silver anodized aluminum | | | | WEIGHT | PACKING SIZE |
|-------------------------------------|-----------------|------------|-----------------|--------------|-------------------------|
| ARTICLE | EXTERNAL (x-y) | POSTER | COPY | WITH PACKING | *W X H X D |
| UCN205N081 | 9.69" X 12.17" | 8.5" X 11" | 8.19" X 10.67" | 1.102 lbs | 10.63" X 12.99" X 0.83" |
| UCN205N017 | 12.17" X 18.19" | 11" X 17" | 10.67" X 16.69" | 1.873 lbs | 12.99" X 18.90" X 0.83" |
| UCN205N012 | 18.19" X 23.19" | 17" X 22" | 16.69" X 21.69" | 2.711 lbs | 19.29" X 24.41" X 0.83" |
| UCN205N018 | 19.21" X 25.20" | 18" X 24" | 17.72" X 23.70" | 2.645 lbs | 20.08" X 25.98" X 0.83" |
| UCN205N013 | 19.21" X 31.18" | 18" X 30" | 17.72" X 29.69" | 3.637 lbs | 20.47" X 32.28" X 0.83" |
| UCN155N023 | 21.18" X 31.18" | 20" X 30" | 19.69" X 29.69" | 3.637 lbs | 22.05" X 31.89" X 0.91" |
| UCN155N034 | 31.18" X 41.18" | 30" X 40" | 29.69" X 39.69" | 6.944 lbs | 31.89" X 42.13" X 0.91" |

*W:Width H: Height D: Depth



Snap Frames



1" / 25 mm Profile, 45° - Round

- Ideal for posters of every size.
- Natural silver anodized and black colors available.
- Mitered and Round corner alternatives.
- Anti-glare poster cover sheet.

Each frame includes wall mounting accessories (4 screws & 4 plugs).

"Optional hangers" permit easy mounting.

Suitable for silk screen printing, max. letter height is 0.59".



UYAA011010
V hanger



UYUP057000
Counter support available. Suitable for both landscape & portrait.

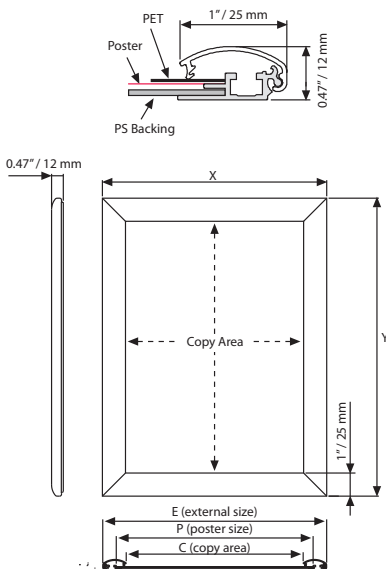

| MATERIAL : Silver anodized aluminum | | | | | | | WEIGHT | PACKING SIZE |
|-------------------------------------|--------------|--------------|-------------|-----------------|------------|-----------------|--------------|-------------------------|
| SILVER MITRED | BLACK MITRED | SILVER ROUND | BLACK ROUND | EXTERNAL (x-y) | POSTER | COPY | WITH PACKING | *W X H X D |
| UCN255N057 | - | - | - | 6.18" X 8.19" | 5" X 7" | 4.29" X 6.30" | 0.551 lbs | 7.48" X 9.45" X 0.83" |
| UCN255N009 | - | - | - | 7.20" X 10.20" | 6" X 9" | 5.31" X 8.31" | 0.771 lbs | 8.27" X 9.06" X 0.83" |
| UCN255N010 | - | - | - | 9.17" X 11.18" | 8" X 10" | 7.28" X 9.29" | 0.837 lbs | 10.63" X 12.20" X 0.83" |
| UCN255N081 | - | - | - | 9.69" X 12.17" | 8.5" X 11" | 7.80" X 10.28" | 1.102 lbs | 10.63" X 12.20" X 0.83" |
| UCN255N011 | - | - | - | 12.17" X 15.20" | 11" X 14" | 10.28" X 13.31" | 1.433 lbs | 13.39" X 16.54" X 0.83" |
| UCN255N017 | UCN255B017 | UCN250N017 | UCN250B017 | 12.17" X 18.19" | 11" X 17" | 10.28" X 16.30" | 1.873 lbs | 12.99" X 18.90" X 0.83" |
| UCN255N014 | UCN255B014 | - | - | 15.20" X 23.19" | 14" X 22" | 13.31" X 21.30" | 2.711 lbs | 16.54" X 24.41" X 0.83" |
| UCN255N016 | UCN255B016 | UCN250N016 | UCN250B016 | 17.20" X 21.18" | 16" X 20" | 15.31" X 19.29" | 2.425 lbs | 18.50" X 22.44" X 0.83" |
| UCN255N018 | UCN255B018 | UCN250N018 | UCN250B018 | 19.21" X 25.50" | 18" X 24" | 17.32" X 23.31" | 2.645 lbs | 20.08" X 25.98" X 0.83" |
| UCN255N023 | UCN255B023 | UCN250N023 | UCN250B023 | 21.18" X 31.18" | 20" X 30" | 19.29" X 29.29" | 3.637 lbs | 22.05" X 31.89" X 0.91" |
| UCN255N022 | UCN255B022 | UCN250N022 | UCN250B022 | 23.19" X 29.17" | 22" X 28" | 21.30" X 27.28" | 3.637 lbs | 24.02" X 30.31" X 0.83" |
| UCN255N024 | UCN255B024 | UCN250N024 | UCN250B024 | 25.20" X 37.17" | 24" X 36" | 23.31" X 35.28" | 5.070 lbs | 25.98" X 35.58" X 0.83" |
| UCN255N074 | - | - | - | 28.19" X 41.18" | 27" X 40" | 26.30" X 39.29" | 6.613 lbs | 29.53" X 42.13" X 0.83" |
| UCN255N034 | UCN255B034 | UCN250N034 | UCN250B034 | 31.18" X 41.18" | 30" X 40" | 29.29" X 39.29" | 6.945 lbs | 31.89" X 42.13" X 0.91" |
| UCN255N046 | - | UCN250N046 | - | 41.18" X 61.18" | 40" X 60" | 39.29" X 59.29" | 13.227 lbs | 41.73" X 61.81" X 0.91" |



*W:Width H:Height D:Depth

Snap Frames

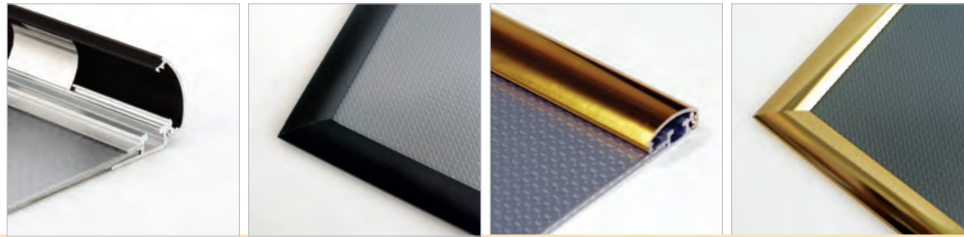

1" / 25 mm Profile, 45° Gold Look Effect

- Attractive brightness on the profile.
- Ideal for posters of every size.
- Mitered corners.
- Anti-glare poster cover sheet.

1" / 25 mm Profile, 45° Black Anodized

- Attractive black anodized effect on the profile.
- Ideal for posters of every size.
- Mitered corners.
- Anti-glare poster cover sheet.

Each frame includes wall mounting accessories (4 screws & 4 plugs).

"Optional hangers" permit easy mounting.



Gold



Black



UYAA011010
V hanger



UYUP057000
Counter support
available. Suitable for
both landscape&portrait.

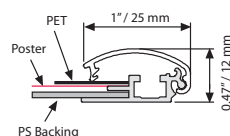
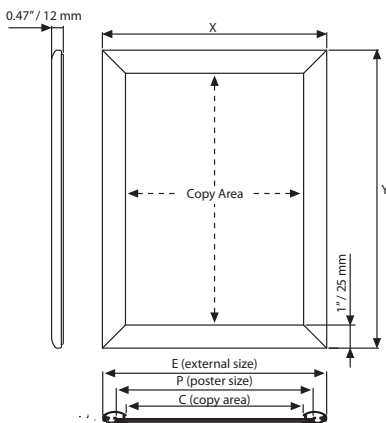

| MATERIAL : Silver anodized aluminum | | | | | WEIGHT | PACKING SIZE |
|-------------------------------------|------------|-----------------|------------|-----------------|--------------|-------------------------|
| BLACK | GOLD | EXTERNAL (x-y) | POSTER | COPIY | WITH PACKING | *W X H X D |
| UCN255B057 | - | 6.18" X 8.19" | 5" X 7" | 4.29" X 6.30" | 0.551 lbs | 7.48" X 9.45" X 0.83" |
| UCN255B009 | UCN255G009 | 7.20" X 10.20" | 6" X 9" | 5.31" X 8.31" | 0.771 lbs | 8.27" X 9.06" X 0.83" |
| UCN255B010 | - | 9.17" X 11.18" | 8" X 10" | 7.28" X 9.29" | 0.837 lbs | 10.63" X 12.20" X 0.83" |
| UCN255B081 | UCN255G081 | 9.69" X 12.17" | 8.5" X 11" | 7.80" X 10.28" | 1.102 lbs | 10.63" X 12.20" X 0.83" |
| UCN255B011 | - | 12.17" X 15.20" | 11" X 14" | 10.28" X 13.31" | 1.433 lbs | 13.39" X 16.54" X 0.83" |
| UCN255B017 | - | 12.17" X 18.19" | 11" X 17" | 10.28" X 16.30" | 1.873 lbs | 12.99" X 18.90" X 0.83" |
| UCN255B014 | - | 15.20" X 23.19" | 14" X 22" | 13.31" X 21.30" | 2.711 lbs | 16.54" X 24.41" X 0.83" |
| UCN255B016 | - | 17.20" X 21.18" | 16" X 20" | 15.31" X 19.29" | 2.425 lbs | 18.50" X 22.44" X 0.83" |
| UCN255B018 | - | 19.21" X 25.50" | 18" X 24" | 17.32" X 23.31" | 2.645 lbs | 20.08" X 25.98" X 0.83" |
| UCN255B023 | UCN255G023 | 21.18" X 31.18" | 20" X 30" | 19.29" X 29.29" | 3.637 lbs | 22.05" X 31.89" X 0.91" |
| UCN255B022 | - | 23.19" X 29.17" | 22" X 28" | 21.30" X 27.28" | 3.637 lbs | 24.02" X 30.31" X 0.83" |
| UCN255B024 | - | 25.20" X 37.17" | 24" X 36" | 23.31" X 35.28" | 5.070 lbs | 25.98" X 35.58" X 0.83" |
| UCN255B074 | - | 28.19" X 41.18" | 27" X 40" | 26.30" X 39.29" | 6.613 lbs | 29.53" X 42.13" X 0.83" |
| UCN255B034 | UCN255G034 | 31.18" X 41.18" | 30" X 40" | 29.29" X 39.29" | 6.945 lbs | 31.89" X 42.13" X 0.91" |
| UCN255B046 | UCN255G046 | 41.18" X 61.18" | 40" X 60" | 39.29" X 59.29" | 13.227 lbs | 41.73" X 61.81" X 0.91" |

* W:Width H: Height D: Depth



Snap Frames

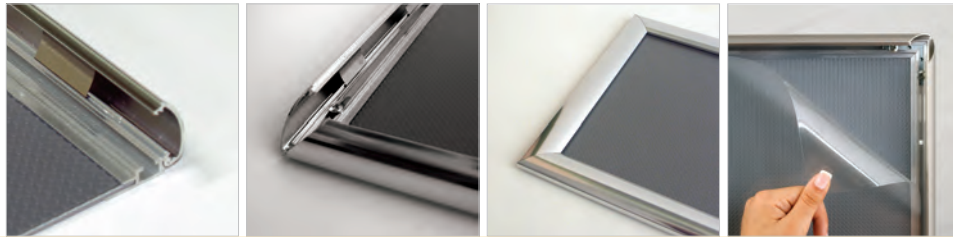



1" / 25 mm Profile, 45° Chrome Look

- Attractive chrome brightness on the profile.
- Ideal for posters of every size.
- Mitered corners.
- Anti-glare poster cover sheet.

1" / 25 mm Profile, 45° Stainless Steel Look

- Attractive stainless steel look on the profile.
- Ideal for posters of every size.
- Mitered corners.
- Anti-glare poster cover sheet.

 Each frame includes wall mounting accessories (4 screws & 4 plugs).

 "Optional hangers" permit easy mounting.



Chrome Look Effect



Stainless Steel Look



UYAA011010
V hanger



UYUP057000
Counter support
available. Suitable for
both landscape&portrait.

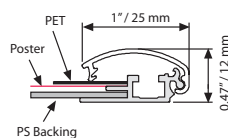
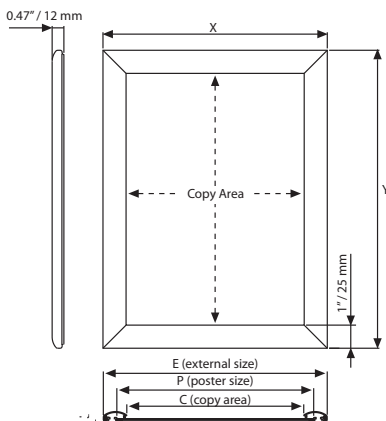

| MATERIAL : Chrome Look Effect / Stainless Steel Look | | | | | WEIGHT | PACKING SIZE |
|--|------------|-----------------|------------|-----------------|--------------|-------------------------|
| CHROME | STAINLESS | EXTERNAL (x-y) | POSTER | COPY | WITH PACKING | *W X H X D |
| UCN255K057 | UCN255S057 | 6.18" X 8.19" | 5" X 7" | 4.29" X 6.30" | 0.551 lbs | 7.48" X 9.45" X 0.83" |
| UCN255K009 | UCN255S009 | 7.20" X 10.20" | 6" X 9" | 5.31" X 8.31" | 0.771 lbs | 8.27" X 9.06" X 0.83" |
| UCN255K010 | UCN255S010 | 9.17" X 11.18" | 8" X 10" | 7.28" X 9.29" | 0.837 lbs | 10.63" X 12.20" X 0.83" |
| UCN255K081 | UCN255S081 | 9.69" X 12.17" | 8.5" X 11" | 7.80" X 10.28" | 1.102 lbs | 10.63" X 12.20" X 0.83" |
| UCN255K011 | UCN255S011 | 12.17" X 15.20" | 11" X 14" | 10.28" X 13.31" | 1.433 lbs | 13.39" X 16.54" X 0.83" |
| UCN255K017 | UCN255S017 | 12.17" X 18.19" | 11" X 17" | 10.28" X 16.30" | 1.873 lbs | 12.99" X 18.90" X 0.83" |
| UCN255K014 | UCN255S014 | 15.20" X 23.19" | 14" X 22" | 13.31" X 21.30" | 2.711 lbs | 16.54" X 24.41" X 0.83" |
| UCN255K016 | UCN255S016 | 17.20" X 21.18" | 16" X 20" | 15.31" X 19.29" | 2.425 lbs | 18.50" X 22.44" X 0.83" |
| UCN255K018 | UCN255S018 | 19.21" X 25.50" | 18" X 24" | 17.32" X 23.31" | 2.645 lbs | 20.08" X 25.98" X 0.83" |
| UCN255K023 | UCN255S023 | 21.18" X 31.18" | 20" X 30" | 19.29" X 29.29" | 3.637 lbs | 22.05" X 31.89" X 0.91" |
| UCN255K022 | UCN255S022 | 23.19" X 29.17" | 22" X 28" | 21.30" X 27.28" | 3.637 lbs | 24.02" X 30.31" X 0.83" |
| UCN255K024 | UCN255S024 | 25.20" X 37.17" | 24" X 36" | 23.31" X 35.28" | 5.070 lbs | 25.98" X 35.58" X 0.83" |
| UCN255K074 | UCN255S074 | 28.19" X 41.18" | 27" X 40" | 26.30" X 39.29" | 6.613 lbs | 29.53" X 42.13" X 0.83" |
| UCN255K034 | UCN255S034 | 31.18" X 41.18" | 30" X 40" | 29.29" X 39.29" | 6.945 lbs | 31.89" X 42.13" X 0.91" |
| UCN255K046 | UCN255S046 | 41.18" X 61.18" | 40" X 60" | 39.29" X 59.29" | 13.227 lbs | 41.73" X 61.81" X 0.91" |

* W:Width H: Height D: Depth



Snap Frames



1" / 25 mm Profile, 45°

Wood Look Effect

- Attractive wooden finish effect on the profile.
- Ideal for posters of every size.
- Mitered corners.
- Anti-glare poster cover sheet.

1" / 25 mm Profile, 45°

Light Wood Effect

- Attractive light wood finish effect on the profile.
- Ideal for posters of every size.
- Mitered corners.
- Anti-glare poster cover sheet.

Each frame includes wall mounting accessories (4 screws & 4 plugs).

"Optional hangers" permit easy mounting.

Suitable for silk screen printing, max. letter height is 0.59".

Color options



Dark Wood Light Wood



Wood Effect



Light Wood Effect



UYAA011010
V hanger



UYUP057000
Counter support
available. Suitable for
both landscape&portrait.

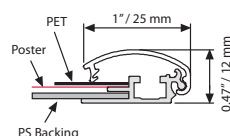
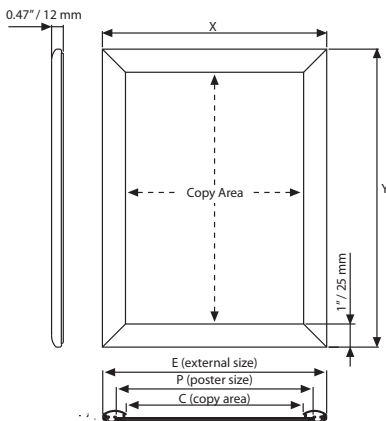

| MATERIAL : Silver anodized aluminum | | | | | WEIGHT | PACKING SIZE |
|-------------------------------------|------------|-----------------|------------|-----------------|--------------|-------------------------|
| WOOD | LIGHT WOOD | EXTERNAL (x-y) | POSTER | COPY | WITH PACKING | *W X H X D |
| UCN255W057 | UCN255W157 | 6.18" X 8.19" | 5" X 7" | 4.29" X 6.30" | 0.551 lbs | 7.48" X 9.45" X 0.83" |
| UCN255W009 | UCN255W109 | 7.20" X 10.20" | 6" X 9" | 5.31" X 8.31" | 0.771 lbs | 8.27" X 9.06" X 0.83" |
| UCN255W010 | UCN255W110 | 9.17" X 11.18" | 8" X 10" | 7.28" X 9.29" | 0.837 lbs | 10.63" X 12.20" X 0.83" |
| UCN255W081 | UCN255W181 | 9.69" X 12.17" | 8.5" X 11" | 7.80" X 10.28" | 1.102 lbs | 10.63" X 12.20" X 0.83" |
| UCN255W011 | UCN255W111 | 12.17" X 15.20" | 11" X 14" | 10.28" X 13.31" | 1.433 lbs | 13.39" X 16.54" X 0.83" |
| UCN255W017 | UCN255W117 | 12.17" X 18.19" | 11" X 17" | 10.28" X 16.30" | 1.873 lbs | 12.99" X 18.90" X 0.83" |
| UCN255W014 | UCN255W114 | 15.20" X 23.19" | 14" X 22" | 13.31" X 21.30" | 2.711 lbs | 16.54" X 24.41" X 0.83" |
| UCN255W016 | UCN255W116 | 17.20" X 21.18" | 16" X 20" | 15.31" X 19.29" | 2.425 lbs | 18.50" X 22.44" X 0.83" |
| UCN255W018 | UCN255W118 | 19.21" X 25.50" | 18" X 24" | 17.32" X 23.31" | 2.645 lbs | 20.08" X 25.98" X 0.83" |
| UCN255W023 | UCN255W123 | 21.18" X 31.18" | 20" X 30" | 19.29" X 29.29" | 3.637 lbs | 22.05" X 31.89" X 0.91" |
| UCN255W022 | UCN255W122 | 23.19" X 29.17" | 22" X 28" | 21.30" X 27.28" | 3.637 lbs | 24.02" X 30.31" X 0.83" |
| UCN255W024 | UCN255W124 | 25.20" X 37.17" | 24" X 36" | 23.31" X 35.28" | 5.070 lbs | 25.98" X 35.58" X 0.83" |
| UCN255W074 | UCN255W174 | 28.19" X 41.18" | 27" X 40" | 26.30" X 39.29" | 6.613 lbs | 29.53" X 42.13" X 0.83" |
| UCN255W034 | UCN255W134 | 31.18" X 41.18" | 30" X 40" | 29.29" X 39.29" | 6.945 lbs | 31.89" X 42.13" X 0.91" |
| UCN255W046 | UCN255W146 | 41.18" X 61.18" | 40" X 60" | 39.29" X 59.29" | 13.227 lbs | 41.73" X 61.81" X 0.91" |

* W:Width H: Height D: Depth



Coloured Snap Frames



1" / 25 mm Profile, 45°

Coloured Snap Frames

- Powdercoated silky finish
- Ideal for posters of every size.
- Mitred corners.
- Anti-glare poster cover sheet

Each frame includes wall mounting accessories (4 screws & 4 plugs). Each frame is packed individually in a cardboard box.

Custom sizes are available.

Optional hangers permit easy mounting.



Black - RAL 9005



White - RAL9003



Red - RAL 3020



UYAA011010
V hanger / Aufhänger



UYUP057000
Counter support
available. Suitable for
both landscape & portrait.

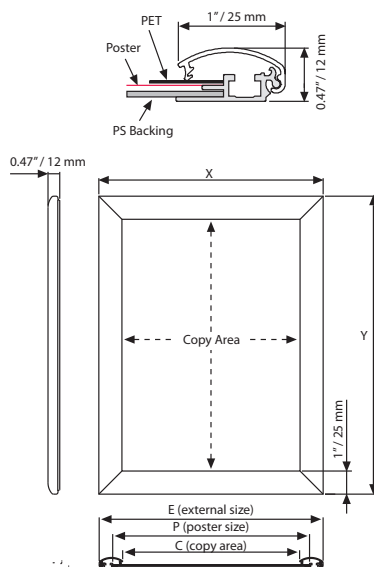

| MATERIAL : Powdercoated Silky Finish | | | | | | WEIGHT | PACKING SIZE |
|--------------------------------------|------------|------------|-----------------|------------|-----------------|--------------|-------------------------|
| RED | WHITE | BLACK | EXTERNAL (x-y) | POSTER | COPY | WITH PACKING | *W X H X D |
| UCN2553057 | UCN2552057 | UCN2551057 | 6.18" X 8.19" | 5" X 7" | 4.29" X 6.30" | 0.551 lbs | 7.48" X 9.45" X 0.83" |
| UCN2553009 | UCN2552009 | UCN2551009 | 7.20" X 10.20" | 6" X 9" | 5.31" X 8.31" | 0.771 lbs | 8.27" X 9.06" X 0.83" |
| UCN2553010 | UCN2552010 | UCN2551010 | 9.17" X 11.18" | 8" X 10" | 7.28" X 9.29" | 0.837 lbs | 10.63" X 12.20" X 0.83" |
| UCN2553081 | UCN2552081 | UCN2551081 | 9.69" X 12.17" | 8.5" X 11" | 7.80" X 10.28" | 1.102 lbs | 10.63" X 12.20" X 0.83" |
| UCN2553011 | UCN2552011 | UCN2551011 | 12.17" X 15.20" | 11" X 14" | 10.28" X 13.31" | 1.433 lbs | 13.39" X 16.54" X 0.83" |
| UCN2553017 | UCN2552017 | UCN2551017 | 12.17" X 18.19" | 11" X 17" | 10.28" X 16.30" | 1.873 lbs | 12.99" X 18.90" X 0.83" |
| UCN2553014 | UCN2552014 | UCN2551014 | 15.20" X 23.19" | 14" X 22" | 13.31" X 21.30" | 2.711 lbs | 16.54" X 24.41" X 0.83" |
| UCN2553016 | UCN2552016 | UCN2551016 | 17.20" X 21.18" | 16" X 20" | 15.31" X 19.29" | 2.425 lbs | 18.50" X 22.44" X 0.83" |
| UCN2553018 | UCN2552018 | UCN2551018 | 19.21" X 25.50" | 18" X 24" | 17.32" X 23.31" | 2.645 lbs | 20.08" X 25.98" X 0.83" |
| UCN2553023 | UCN2552023 | UCN2551023 | 21.18" X 31.18" | 20" X 30" | 19.29" X 29.29" | 3.637 lbs | 22.05" X 31.89" X 0.91" |
| UCN2553022 | UCN2552022 | UCN2551022 | 23.19" X 29.17" | 22" X 28" | 21.30" X 27.28" | 3.637 lbs | 24.02" X 30.31" X 0.83" |
| UCN2553024 | UCN2552024 | UCN2551024 | 25.20" X 37.17" | 24" X 36" | 23.31" X 35.28" | 5.070 lbs | 25.98" X 35.58" X 0.83" |
| UCN2553074 | UCN2552074 | UCN2551074 | 28.19" X 41.18" | 27" X 40" | 26.30" X 39.29" | 6.613 lbs | 29.53" X 42.13" X 0.83" |
| UCN2553034 | UCN2552034 | UCN2551034 | 31.18" X 41.18" | 30" X 40" | 29.29" X 39.29" | 6.945 lbs | 31.89" X 42.13" X 0.91" |
| UCN2553046 | UCN2552046 | UCN2551046 | 41.18" X 61.18" | 40" X 60" | 39.29" X 59.29" | 13.227 lbs | 41.73" X 61.81" X 0.91" |

*W:Width H: Height D: Depth





Snap Frames



1.18" / 30 mm Profile, 45° - Round

- Ideal for posters of every size.
- Natural silver anodized and black colors available.
- Mitered and Round corner alternatives.
- Anti-glare poster cover sheet.

 Each frame includes wall mounting accessories (4 screws & 4 plugs).

 "Optional hangers" permit easy mounting.

 Suitable for silk screen printing, max. letter height is 0.79".



UYAA011010
V hanger

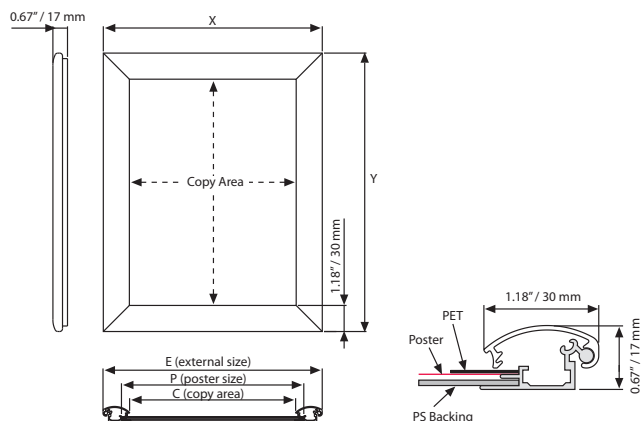

| MATERIAL : Silver anodized aluminum | | | | | WEIGHT | PACKING SIZE |
|-------------------------------------|------------|-----------------|------------|-----------------|--------------|-------------------------|
| MITRED | ROUND | EXTERNAL (x-y) | POSTER | COPY | WITH PACKING | *W X H X D |
| UCN305N057 | UCN300N057 | 6.69" X 8.69" | 5" X 7" | 4.41" X 6.41" | 0.970 lbs | 11.30" X 9.37" X 1.22" |
| UCN305N009 | UCN300N009 | 7.69" X 10.69" | 6" X 9" | 5.41" X 8.41" | 1.168 lbs | 8.39" X 11.38" X 1.22" |
| UCN305N010 | UCN300N010 | 9.69" X 11.69" | 8" X 10" | 7.41" X 9.41" | 1.366 lbs | 10.39" X 12.36" X 1.22" |
| UCN305N081 | UCN300N081 | 10.19" X 12.69" | 8.5" X 11" | 7.91" X 10.41" | 1.410 lbs | 10.87" X 13.39" X 1.22" |
| UCN305N014 | UCN300N014 | 12.69" X 15.69" | 11" X 14" | 10.41" X 13.41" | 1.829 lbs | 13.39" X 16.38" X 1.22" |
| UCN305N017 | UCN300N017 | 12.69" X 18.69" | 11" X 17" | 10.41" X 16.41" | 2.050 lbs | 13.39" X 19.37" X 1.22" |
| UCN305N012 | UCN300N012 | 15.69" X 23.69" | 14" X 22" | 13.41" X 21.41" | 3.042 lbs | 16.38" X 24.37" X 1.22" |
| UCN305N016 | UCN300N016 | 17.69" X 21.69" | 16" X 20" | 15.41" X 19.41" | 3.042 lbs | 18.39" X 22.36" X 1.22" |
| UCN305N018 | UCN300N018 | 19.69" X 25.69" | 18" X 24" | 17.41" X 23.41" | 3.791 lbs | 20.39" X 26.38" X 1.22" |
| UCN305N023 | UCN300N023 | 21.69" X 31.69" | 20" X 30" | 19.41" X 29.41" | 4.519 lbs | 22.44" X 32.28" X 1.22" |
| UCN305N022 | UCN300N022 | 23.69" X 29.69" | 22" X 28" | 21.41" X 27.41" | 4.629 lbs | 24.37" X 30.39" X 1.22" |
| UCN305N024 | UCN300N024 | 25.69" X 37.69" | 24" X 36" | 23.41" X 35.41" | 6.812 lbs | 26.38" X 38.39" X 1.22" |
| UCN305N074 | UCN300N074 | 28.69" X 41.69" | 27" X 40" | 26.41" X 39.41" | 7.583 lbs | 29.37" X 42.36" X 1.22" |
| UCN305N034 | UCN300N034 | 31.69" X 41.69" | 30" X 40" | 29.41" X 39.41" | 7.936 lbs | 32.28" X 42.52" X 1.22" |
| UCN305N046 | UCN300N046 | 41.69" X 61.69" | 40" X 60" | 39.41" X 59.41" | 14.881 lbs | 41.73" X 61.81" X 1.22" |

*W:Width H: Height D: Depth



Snap Frames



1.25" / 32 mm Profile, 45° - Round

- Ideal for posters of every size.
- Natural silver anodized and black colors available.
- Mitered and Round corner alternatives.
- Anti-glare poster cover sheet.

Each frame includes wall mounting accessories (4 screws & 4 plugs).

"Optional hangers" permit easy mounting.

Suitable for silk screen printing, max. letter height is 0.63".



UYAA011010
V hanger

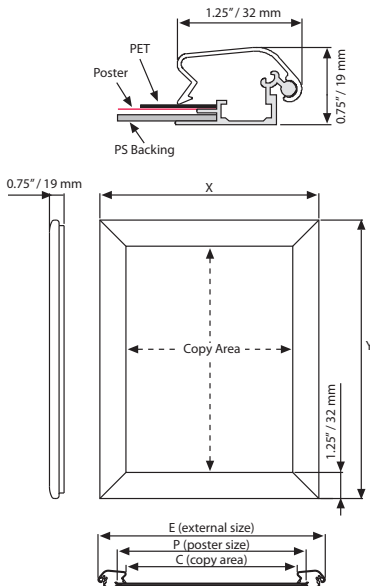

| MATERIAL : Silver anodized aluminum | | | | | | | WEIGHT | PACKING SIZE |
|-------------------------------------|--------------|--------------|-------------|-----------------|------------|-----------------|--------------|-------------------------|
| SILVER MITRED | BLACK MITRED | SILVER ROUND | BLACK ROUND | EXTERNAL (x-y) | POSTER | COPY | WITH PACKING | *W X H X D |
| UCN325N057 | - | - | - | 6.69" X 8.70" | 5" X 7" | 4.21" X 6.22" | 0.705 lbs | 8.27" X 9.84" X 1.22" |
| UCN325N010 | - | - | - | 9.69" X 11.69" | 8" X 10" | 7.20" X 9.21" | 1.322 lbs | 10.63" X 12.99" X 1.22" |
| UCN325N081 | - | - | - | 10.20" X 12.68" | 8.5" X 11" | 7.72" X 10.20" | 1.500 lbs | 11.02" X 13.39" X 1.22" |
| UCN325N014 | - | - | - | 12.68" X 15.71" | 11" X 14" | 10.20" X 13.23" | 1.873 lbs | 13.78" X 17.32" X 1.22" |
| UCN325N017 | - | - | - | 12.68" X 18.70" | 11" X 17" | 10.20" X 16.22" | 2.380 lbs | 13.78" X 18.90" X 1.22" |
| UCN325N016 | - | - | - | 17.72" X 21.69" | 16" X 20" | 15.24" X 19.21" | 2.755 lbs | 18.50" X 22.44" X 1.22" |
| UCN325N018 | - | UCN320N018 | UCN320B018 | 19.72" X 25.71" | 18" X 24" | 17.24" X 23.23" | 3.306 lbs | 20.47" X 26.38" X 1.22" |
| UCN325N023 | - | - | - | 21.69" X 31.69" | 20" X 30" | 19.21" X 29.21" | 4.519 lbs | 22.44" X 32.28" X 1.22" |
| UCN325N022 | - | - | - | 23.70" X 29.69" | 22" X 28" | 21.22" X 27.20" | 5.732 lbs | 24.41" X 30.71" X 1.22" |
| UCN325N024 | - | UCN320N023 | - | 25.71" X 37.68" | 24" X 36" | 23.23" X 35.20" | 5.621 lbs | 26.77" X 38.58" X 1.22" |
| UCN325N074 | - | - | - | 27.80" X 41.69" | 27" X 40" | 26.22" X 39.21" | 7.275 lbs | 29.53" X 42.13" X 1.22" |
| UCN325N036 | UCN325B036 | - | - | 37.72" X 49.72" | 36" X 48" | 35.24" X 47.24" | 9.920 lbs | 36.61" X 48.82" X 1.22" |
| UCN325N034 | - | UCN320N034 | - | 31.69" X 41.69" | 30" X 40" | 29.21" X 39.21" | 7.936 lbs | 32.28" X 42.52" X 1.22" |
| UCN325N046 | UCN325B046 | UCN320N046 | - | 41.69" X 61.69" | 40" X 60" | 39.21" X 59.21" | 14.881 lbs | 41.73" X 61.81" X 1.22" |

* W:Width H: Height D: Depth



Snap Frame 1.25" / 32 mm with Safe Corners



1.25" / 32 mm Profile, 45° - Safe Corners

- Ideal for posters of every size.
- Natural silver anodized and black colors available.
- Mitered and Round corner alternatives.
- Anti-glare poster cover sheet.



Each frame includes wall mounting accessories (4 screws & 4 plugs).



"Optional hangers" permit easy mounting.



Suitable for silk screen printing, max. letter height is 0.63".



Safe edges



UYAA011010
V hanger

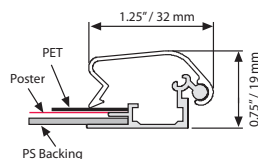
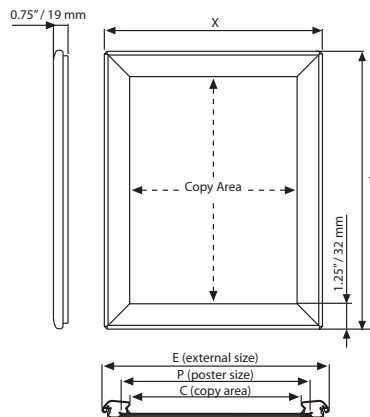

| MATERIAL : Silver anodized aluminum | | | | | WEIGHT | PACKING SIZE |
|-------------------------------------|------------|-----------------|-----------|-----------------|--------------|-------------------------|
| SILVER | BLACK | EXTERNAL (x-y) | POSTER | COPY | WITH PACKING | *W X H X D |
| UCN321N018 | UCN321B018 | 19.72" X 25.71" | 18" X 24" | 17.24" X 23.23" | 3.306 lbs | 20.47" X 26.38" X 1.22" |
| UCN321N023 | UCN321B023 | 21.69" X 31.69" | 20" X 30" | 19.41" X 29.41" | 4.519 lbs | 22.44" X 32.28" X 1.22" |
| UCN321N022 | UCN321B022 | 23.70" X 29.69" | 22" X 28" | 21.22" X 27.20" | 5.732 lbs | 24.41" X 30.71" X 1.22" |
| UCN321N024 | UCN321B024 | 25.71" X 37.68" | 24" X 36" | 23.23" X 35.20" | 5.621 lbs | 26.77" X 38.58" X 1.22" |
| UCN321N074 | UCN321B074 | 28.70" X 41.69" | 27" X 40" | 26.22" X 39.21" | 7.275 lbs | 29.53" X 42.13" X 1.22" |
| UCN321N034 | UCN321B034 | 31.69" X 41.69" | 30" X 40" | 29.41" X 39.41" | 7.936 lbs | 32.28" X 42.52" X 1.22" |
| UCN321N046 | UCN321B046 | 41.69" X 61.69" | 40" X 60" | 39.41" X 59.41" | 14.881 lbs | 41.73" X 61.81" X 1.22" |



*W:Width H: Height D: Depth

Snap Frames 1.77" / 45 mm



- Ideal for large-scale posters.
- Natural silver anodized and black colors available.
- Mitered corners.
- Anti-glare poster cover sheet.

Each frame includes wall mounting accessories (4 screws & 4 plugs). Each frame is packed individually in a cardboard box.

"Optional hangers" permit easy mounting.

Suitable for silk screen printing, max. letter height is 0.79" for 1.50". Suitable for silk screen printing, max. letter height is 1" for 1.77".



1.77" / 45 mm



UYAA011010
V hanger

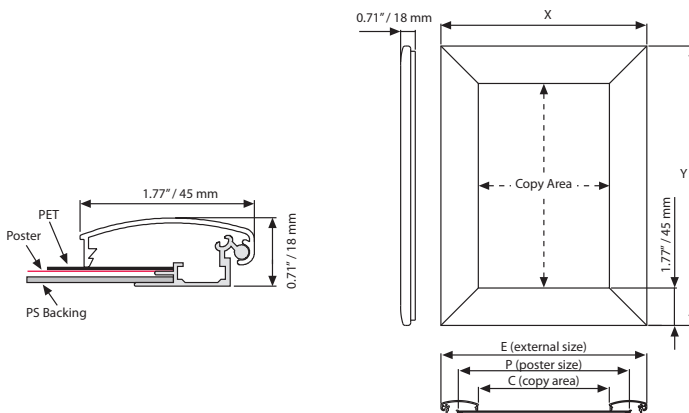
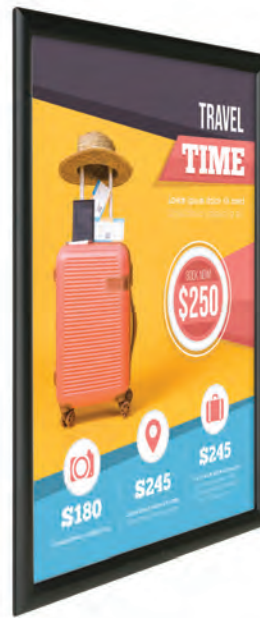

| 1.50" / 38 mm Profile, 45° : Silver anodized aluminum | | | | WEIGHT | PACKING SIZE |
|---|-----------------|------------|-----------------|--------------|-------------------------|
| ARTICLE | EXTERNAL (x-y) | POSTER | COPY | WITH PACKING | *W X H X D |
| UCN385G081 | 10.27" X 12.77" | 8.5" X 11" | 7.28" X 9.78" | 1.719 lbs | 10.87" X 12.39" X 1.22" |
| UCN385G017 | 12.77" X 18.77" | 11" X 17" | 9.78" X 15.78" | 2.226 lbs | 13.39" X 19.37" X 1.22" |
| UCN385G023 | 21.77" X 31.77" | 20" X 30" | 18.78" X 28.78" | 4.739 lbs | 22.44" X 32.28" X 1.22" |
| UCN385G034 | 31.77" X 41.77" | 30" X 40" | 28.78" X 38.78" | 8.421 lbs | 32.28" X 42.52" X 1.22" |
| UCN385G046 | 41.77" X 61.77" | 40" X 60" | 38.78" X 58.78" | 15.211 lbs | 41.73" X 61.81" X 1.22" |

| 1.77" / 45 mm Profile, 45° : Silver & black anodized aluminum | | | | WEIGHT | PACKING SIZE | |
|---|------------|-----------------|-----------|-----------------|--------------|-------------------------|
| SILVER | BLACK | EXTERNAL (x-y) | POSTER | COPY | WITH PACKING | *W X H X D |
| UCN455N023 | UCN455B023 | 21.69" X 31.69" | 20" X 30" | 18.23" X 28.23" | 4.739 lbs | 22.44" X 32.28" X 1.22" |
| UCN455N034 | UCN455B034 | 31.69" X 41.69" | 30" X 40" | 28.23" X 38.23" | 9.149 lbs | 32.28" X 42.25" X 1.22" |
| UCN455N046 | UCN455B046 | 41.69" X 61.69" | 40" X 60" | 38.23" X 58.23" | 15.873 lbs | 41.73" X 61.81" X 1.22" |
| UCN455N074 | UCN455B074 | 28.70" X 41.69" | 27" X 40" | 25.24" X 38.23" | 7.716 lbs | 29.53" X 42.13" X 1.22" |
| UCN455N036 | UCN455B036 | 37.72" X 49.72" | 36" X 48" | 34.25" X 46.26" | 9.920 lbs | 36.61" X 48.82" X 1.22" |

*W:Width H: Height D:Depth





Snap Frames



1.81" / 46 mm Profile, 45° - Round

- Ideal for large-scaled posters.
- Natural silver anodized and black colors available.
- Mitered and Round corner alternatives.
- Anti-glare poster cover sheet.

 Each frame includes wall mounting accessories (4 screws & 4 plugs).

 "Optional hangers" permit easy mounting.

 Suitable for silk screen printing, max. letter height is 1.10".



UYAA011010
V hanger

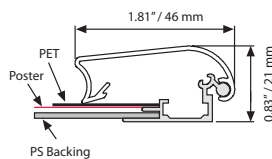
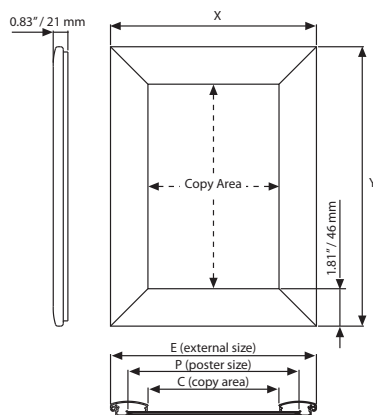

| MATERIAL : Silver & black anodized aluminum | | | | WEIGHT | PACKING SIZE |
|---|------------|-----------------|-------------|-----------------|---------------------------------------|
| MITRED | ROUND | EXTERNAL (x-y) | POSTER COPY | WITH PACKING | *W X H X D |
| UCN465N023 | UCN460N023 | 21.69" X 31.69" | 20" X 30" | 18.23" X 28.23" | 4.739 lbs 22.44" X 32.28" X 1.22" |
| UCN465N034 | UCN460N034 | 31.69" X 41.69" | 30" X 40" | 28.23" X 38.23" | 9.149 lbs 32.28" X 42.52" X 1.22" |
| UCN465N036 | UCN460N036 | 37.69" X 49.69" | 36" X 48" | 34.23" X 46.23" | 13.448 lbs 38.39" X 50.39" X 1.22" |
| UCN465N046 | UCN460N046 | 41.69" X 61.69" | 40" X 60" | 38.23" X 58.23" | 15.873 lbs 41.73" X 61.81" X 1.22" |

*W:Width H: Height D: Depth



Fire Resistant Snap Frame 1" / 25 mm





See movie at our website www.mtdisplays.com.tr



1" / 25 mm Profile, 45°

- Fire classified for EN13501-1 Class B s1 d0, hardly inflammable (B1 rated for German DIN standards)
- 25mm wide silver anodised profile with mitred corners.
- B1 fire resistant anti-reflex poster protection.
- Perfect for educational, commercial and public places.

 Fire Resistant Snap Frames supplied without screws and wall plugs.

 No assembly required.



UYAA011010
Optional V hanger /
Aufhänger

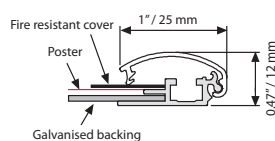
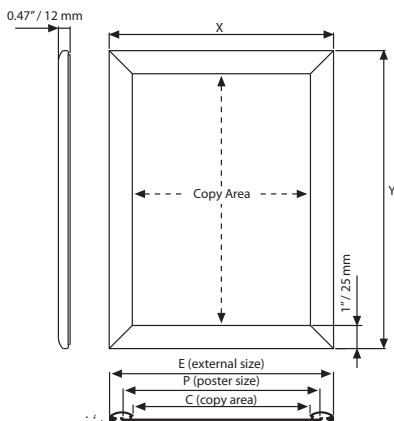

| MATERIAL : Silver anodised aluminium | | | | WEIGHT | PACKING SIZE |
|--------------------------------------|-----------------|------------|-----------------|--------------|-------------------------|
| ARTICLE | EXTERNAL (x-y) | POSTER | COPY | WITH PACKING | *W X H X D |
| UCFR255N81 | 9.69" X 12.17" | 8.5" X 11" | 7.80" X 10.28" | 1.455 lbs | 10.63" X 12.20" X 0.83" |
| UCFR255N11 | 12.17" X 18.19" | 11" X 17" | 10.28" X 16.30" | 2.358 lbs | 12.99" X 18.90" X 0.83" |
| UCFR255N14 | 12.17" X 15.20" | 11" X 14" | 10.28" X 13.31" | 2.270 lbs | 13.39" X 16.54" X 0.83" |
| UCFR255N12 | 18.19" X 23.19" | 17" X 22" | 16.30" X 21.30" | 5.070 lbs | 18.98" X 24.01" X 0.83" |
| UCFR255N82 | 19.21" X 25.50" | 18" X 24" | 17.32" X 23.31" | 5.401 lbs | 20.08" X 25.98" X 0.83" |
| UCFR255N23 | 21.18" X 31.18" | 20" X 30" | 19.29" X 29.29" | 5.908 lbs | 22.05" X 31.89" X 0.91" |
| UCFR255N24 | 25.20" X 37.17" | 24" X 36" | 23.31" X 35.28" | 8.289 lbs | 25.98" X 38.18" X 0.83" |
| UCFR255N34 | 31.18" X 41.18" | 30" X 40" | 29.29" X 39.29" | 14.175 lbs | 31.89" X 42.13" X 0.91" |



*W:Width H: Height D: Depth

Window Frames

1" / 25 mm



See movie at our website www.mtdisplays.com.tr



The Window Frame system is available in 1" and 1.25" profiles. You can easily change the poster by opening the front profile. 2 anti-reflex PET sheets cover posters. Can be displayed both indoor & outdoor. The system includes decorative back profile to hide the double-sided adhesive tape which holds the frame to the window. Anti-glare poster cover sheet.

Double PET cover, double-sided tape a round the frame internal & external.

Please clean the surface before applying the double-sided tape for better application. Suitable for silk screen printing, max. letter height is 0.59".



1" / 25 mm

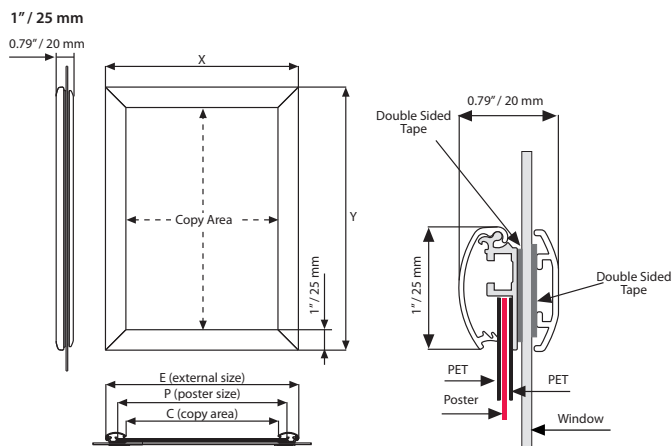

| 1" / 25 mm : Silver anodized aluminum | | | | | WEIGHT | PACKING SIZE |
|---------------------------------------|------------|-----------------|------------|-----------------|--------------|-------------------------|
| SILVER | BLACK | EXTERNAL (x-y) | POSTER | COPY | WITH PACKING | *W X H X D |
| UCW255N481 | UCW255B481 | 9.69" X 12.17" | 8.5" X 11" | 7.80" X 10.28" | 1.102 lbs | 10.63" X 12.99" X 0.83" |
| UCW255N417 | UCW255B417 | 12.17" X 18.19" | 11" X 17" | 10.28" X 16.30" | 1.873 lbs | 12.99" X 18.90" X 0.83" |
| UCW255N422 | UCW255B422 | 23.19" X 29.17" | 22" X 28" | 21.30" X 27.28" | 3.637 lbs | 24.02" X 30.31" X 0.83" |
| UCW255N423 | UCW255B423 | 21.18" X 31.18" | 20" X 30" | 19.29" X 29.29" | 3.637 lbs | 22.44" X 32.28" X 1.22" |
| UCW255N434 | UCW255B434 | 31.18" X 41.18" | 30" X 40" | 29.29" X 39.29" | 6.944 lbs | 31.89" X 42.13" X 0.91" |
| UCW255N446 | UCW255B446 | 41.18" X 61.18" | 40" X 60" | 39.29" X 59.29" | 13.227 lbs | 41.73" X 61.81" X 0.91" |



* W:Width H: Height D: Depth

Fancy Frames



Fancy Frames with a snap open design are a simple to use framing system that makes changing graphics easy. The Fancy Frames come in different sizes and fit in decorative frames for use in a more classic and traditional setting.

Fancy frames come standard with anti-glare poster cover sheet.

 Each frame includes wall mounting accessories (4 screws & 4 plugs).

 "Optional hangers" permit easy mounting.

 Suitable for silk-screen printing max. letter height is 0.63".



Beige

Silver

Black

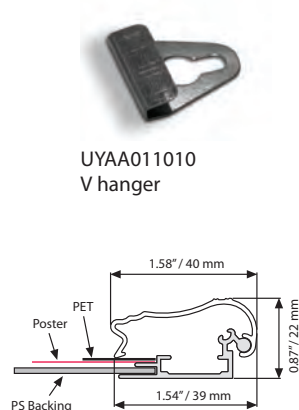
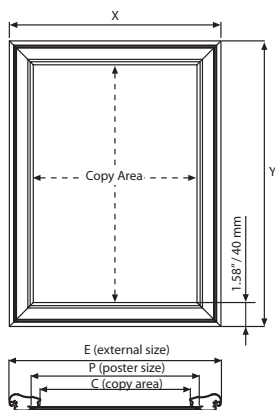

| MATERIAL : Silver, Black and Beige anodized aluminum | | | | | | WEIGHT | PACKING SIZE |
|--|------------|------------|-----------------|-----------|-----------------|--------------|-------------------------|
| SILVER | BLACK | BEIGE | EXTERNAL (x-y) | POSTER | COPY | WITH PACKING | *W X H X D |
| UCF405N022 | UCF405B022 | UCF405C022 | 26.18" X 38.15" | 22" X 28" | 21.14" X 27.13" | 5.291 lbs | 24.41" X 30.71" X 1.22" |
| UCF405N024 | UCF405B024 | UCF405C024 | 24.17" X 30.16" | 24" X 36" | 23.15" X 35.12" | 5.732 lbs | 26.77" X 38.58" X 1.22" |



*W:Width H: Height D: Depth

Double Sided Snap Frames 1" / 25 mm



See movie at our website www.mtdisplays.com.tr



A suitable way to present your messages and posters in spaces where you have no wall mounting possibilities. If suspended from the ceiling via wire cables in front of shop windows, the posters can be viewed both from the inside and from the outside. Anti-glare poster cover sheet.

Each frame includes hanging hooks for suspension.

! All accessories are optional, not included in the original box. Suitable for silk screen printing, max. letter height is 0.47" - 0.55".

Optional accessories



Free hanging hooks come standard with frames.



Ceiling hangers are optional.

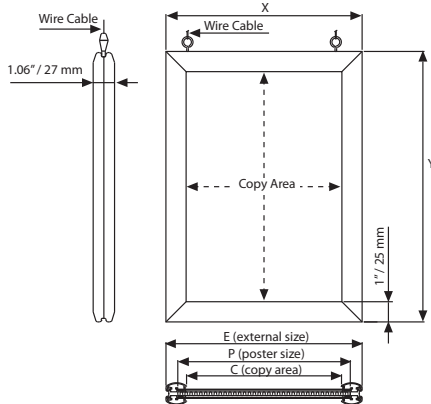

Hanging Kit
UYAA001030 for small sizes. (8.5"x11" to 24"x36")
UYAA001130 for big sizes. (27"x40" to 40"x60")
Hanger kit to be ordered separately.

| MATERIAL : Silver anodized aluminum | | | | WEIGHT | PACKING SIZE |
|-------------------------------------|-----------------|------------|-----------------|--------------|-------------------------|
| ARTICLE | EXTERNAL (x-y) | POSTER | COPY | WITH PACKING | *W X H X D |
| UCD255N281 | 9.68" X 12.18" | 8.5" X 11" | 7.79" X 10.29" | 1.984 lbs | 9.84" X 12.60" X 1.38" |
| UCD255N217 | 12.18" X 18.18" | 11" X 17" | 10.29" X 16.29" | 3.196 lbs | 12.60" X 18.90" X 1.38" |
| UCD255N222 | 23.18" X 29.18" | 22" X 28" | 21.29" X 27.29" | 6.172 lbs | 22.83" X 29.92" X 1.38" |
| UCD255N223 | 21.18" X 31.18" | 20" X 30" | 19.29" X 29.29" | 7.936 lbs | 22.44" X 32.28" X 1.38" |
| UCD255N224 | 25.18" X 37.18" | 24" X 36" | 23.29" X 35.29" | 8.157 lbs | 25.98" X 37.80" X 1.38" |
| UCD255N234 | 31.18" X 41.18" | 30" X 40" | 29.29" X 39.29" | 10.361 lbs | 32.28" X 42.52" X 1.38" |
| UCD255N246 | 41.18" X 61.18" | 40" X 60" | 39.29" X 59.29" | 15.983 lbs | 42.13" X 62.60" X 1.38" |



*W:Width H:Height D:Depth

Security Frames

1"/25 mm - 1.65"/42 mm



- Ideal for medium-sized posters.
- It is a secure hard-to-open profile.
- Suitable for open-air use or highly frequented areas accessible to the public.
- Natural silver-anodized and various RAL colors are available.
- Anti-glare poster cover sheet.

 Each frame includes wall mounting accessories (4 screws & 4 plugs). Each frame is packed individually in a cardboard box.

 "Optional hangers" permit easy mounting.

 Suitable for silk screen printing, max. letter height is 0.59" for 1". Suitable for silk screen printing, max. letter height is 0.83" for 1.65". The lever tool should be ordered separately, not included in the original pack.



1" / 25 mm



1.65" / 42 mm



UYAA011010
V hanger



UYUP047000
Levertool for 1.65"



UYUP047100
Levertool for 1"

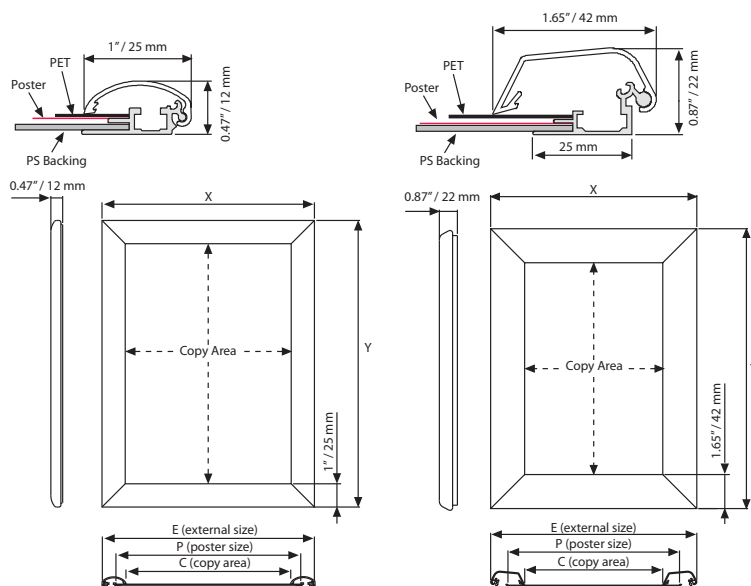

| 1" / 25 mm Profile, 45°: Silver anodized aluminum | | | | WEIGHT | PACKING SIZE |
|---|-----------------|------------|-----------------|--------------|-------------------------|
| ARTICLE | EXTERNAL (x-y) | POSTER | COPY | WITH PACKING | *W X H X D |
| UC2255N081 | 9.69" X 12.17" | 8.5" X 11" | 7.72" X 10.20" | 1.102 lbs | 10.63" X 12.99" X 0.83" |
| UC2255N022 | 23.19" X 29.17" | 22" X 28" | 21.22" X 27.20" | 3.637 lbs | 24.02" X 30.31" X 0.83" |
| UC2255N023 | 21.18" X 31.18" | 20" X 30" | 19.21" X 29.21" | 3.637 lbs | 22.44" X 32.28" X 1.22" |
| UC2255N024 | 25.20" X 37.17" | 24" X 36" | 23.23" X 35.20" | 5.070 lbs | 25.98" X 38.58" X 0.83" |
| UC2255N034 | 31.18" X 41.18" | 30" X 40" | 29.21" X 39.21" | 6.944 lbs | 31.89" X 42.13" X 0.91" |

| 1.65" / 42 mm Profile, 45°: Silver anodized aluminum | | | | WEIGHT | PACKING SIZE |
|--|-----------------|-----------|-----------------|--------------|-------------------------|
| ARTICLE | EXTERNAL (x-y) | POSTER | COPY | WITH PACKING | *W X H X D |
| UC425N023 | 21.69" X 31.69" | 20" X 30" | 18.39" X 28.39" | 4.739 lbs | 22.44" X 32.28" X 1.22" |
| UC425N034 | 31.69" X 41.69" | 30" X 40" | 28.39" X 38.39" | 7.936 lbs | 32.28" X 42.52" X 1.22" |
| UC425N046 | 41.69" X 61.69" | 40" X 60" | 38.39" X 58.39" | 13.227 lbs | 41.73" X 61.81" X 1.22" |



*W:Width H: Height D: Depth

Lockable Snap Frames

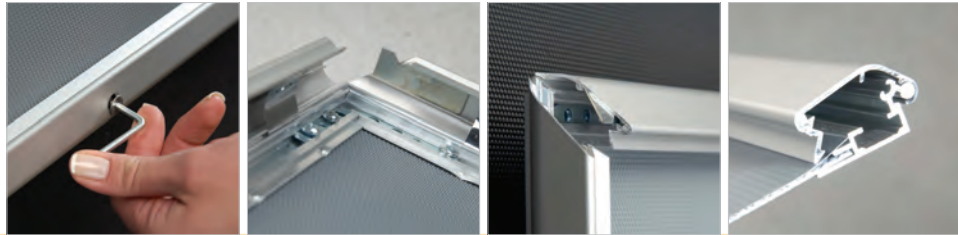

The four sides of the lockable frame open sequentially. The last profile is held in place with a screw on top that can be opened with its key. This system ensures your poster is never accessed by unauthorized third parties. Anti-glare poster cover sheet.

Each frame includes an allen key to open the locked profile. Each frame includes wall mounting accessories (4 screws & 4 plugs).

"Optional hangers" permit easy mounting.

Suitable for silk screen printing, max. letter height is 0.63".



UYAA011010
V hanger



Secured with allen key

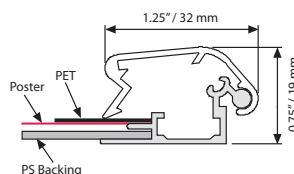
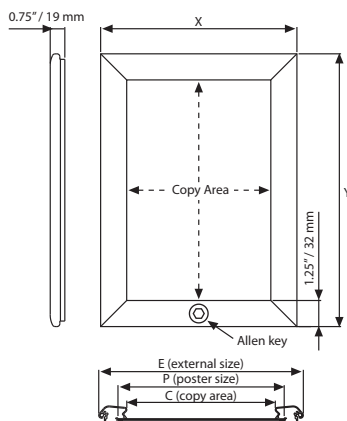

| MATERIAL : Silver anodized aluminum | | | | | WEIGHT | PACKING SIZE |
|-------------------------------------|------------|-----------------|-----------|-----------------|--------------|-------------------------|
| SILVER | BLACK | EXTERNAL (x-y) | POSTER | COPY | WITH PACKING | *W X H X D |
| UCL325N018 | UCL325B018 | 19.72" X 25.71" | 18" X 24" | 17.24" X 23.23" | 3.306 lbs | 20.47" X 26.38" X 1.22" |
| UCL325N022 | UCL325B022 | 23.70" X 29.69" | 22" X 28" | 21.22" X 27.20" | 5.732 lbs | 24.41" X 30.71" X 1.22" |
| UCL325N024 | UCL325B024 | 25.71" X 37.68" | 24" X 36" | 23.23" X 35.20" | 5.621 lbs | 27.17" X 38.58" X 1.22" |



* W:Width H: Height D: Depth

Magnetic Frame Single Sided



See movie at our website www.mtdisplays.com.tr



A poster frame with magnetic cover brings new style to frames. It is very slim and elegant and different than most frames available. Can be used landscape or portrait.

Complete with wall fixing components.

Hidden finger hole on the short profile for easy opening of magnetic cover. No assembly required.

Color options

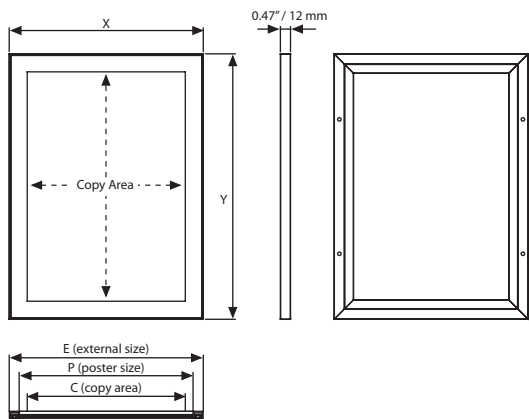
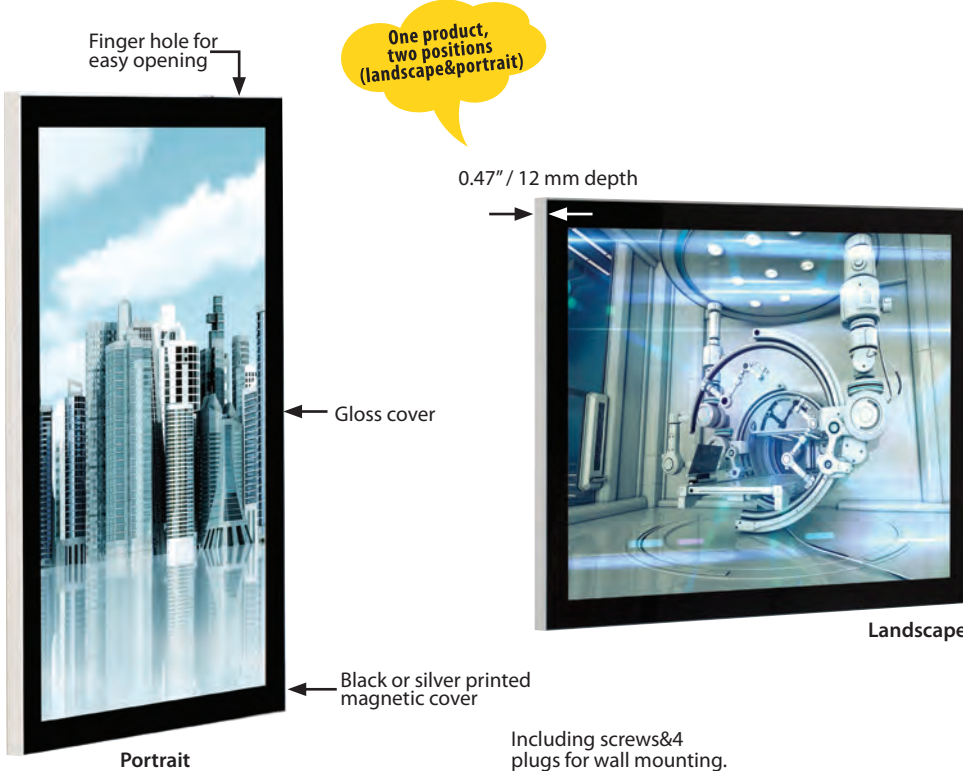

| MATERIAL : Silver anodized aluminum | | | | | | WEIGHT | PACKING SIZE |
|-------------------------------------|------------|-----------------|------------|-----------------|--------------------|--------------|-------------------------|
| SILVER | BLACK | EXTERNAL (x-y) | POSTER | COPY | DESCRIPTION | WITH PACKING | *W X H X D |
| UCMONTB081 | UCMOBTB081 | 9.56" X 12.06" | 8.5" X 11" | 7.83" X 10.33" | Landscape-Portrait | 1.543 lbs | 10.67" X 14.17" X 1.22" |
| UCMONTB017 | UCMOBTB017 | 12.06" X 18.06" | 11" X 17" | 10.33" X 16.33" | Landscape-Portrait | 2.645 lbs | 13.19" X 19.37" X 1.22" |
| UCMONTB018 | UCMOBTB018 | 19.06" X 25.06" | 18" X 24" | 17.33" X 23.33" | Landscape-Portrait | 4.629 lbs | 20.20" X 27.17" X 1.22" |
| UCMONTB022 | UCMOBTB022 | 23.06" X 29.06" | 22" X 28" | 21.33" X 27.33" | Landscape-Portrait | 6.393 lbs | 24.17" X 31.18" X 1.22" |
| UCMONTB023 | UCMOBTB023 | 21.06" X 31.06" | 20" X 30" | 19.33" X 29.33" | Landscape-Portrait | 6.172 lbs | 22.17" X 33.15" X 1.22" |
| UCMONTB024 | UCMOBTB024 | 25.06" X 37.06" | 24" X 36" | 23.33" X 35.33" | Landscape-Portrait | 9.259 lbs | 26.18" X 39.17" X 1.22" |
| UCMONTB034 | UCMOBTB034 | 31.06" X 41.06" | 30" X 40" | 29.33" X 39.33" | Landscape-Portrait | 15.211 lbs | 38.19" X 43.15" X 1.22" |

*W:Width H: Height D: Depth



Magnetic Frame Double Sided



See movie at our website www.mtdisplays.com.tr



A poster frame with magnetic cover brings new style to frames. It is elegant and different than most frames available. Double Sided Magnetic Frame can be easily used landscape or portrait by adjusting suspension cable manually.

Complete with wall fixing components.

Hidden finger hole on the short profile for easy opening of magnetic cover. No assembly required.

Color options



Gray Black

One product,
two positions
(landscape&portrait)

78.74" / 2 meter

Including suspension kit.

0.75" / 19 mm depth

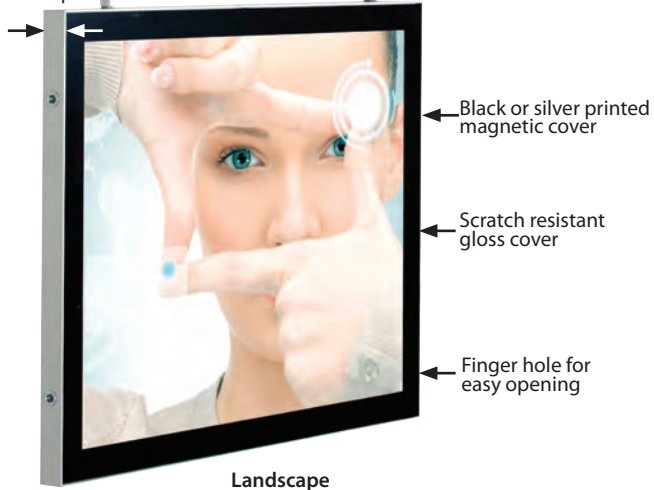

Landscape



Portrait

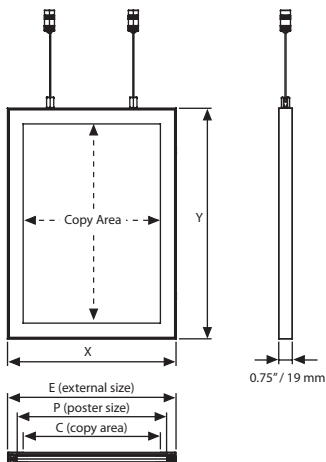

| MATERIAL : Silver anodized aluminum | | | | | | WEIGHT | PACKING SIZE |
|-------------------------------------|------------|-----------------|------------|-----------------|--------------------|--------------|-------------------------|
| SILVER | BLACK | EXTERNAL (x-y) | POSTER | COPY | DESCRIPTION | WITH PACKING | *W X H X D |
| UCMONCB081 | UCMOBCB081 | 9.56" X 12.06" | 8.5" X 11" | 7.83" X 10.33" | Landscape-Portrait | 1.984 lbs | 10.08" X 13.58" X 0.83" |
| UCMONCB017 | UCMOBCB017 | 12.06" X 18.06" | 11" X 17" | 10.33" X 16.33" | Landscape-Portrait | 3.306 lbs | 12.60" X 19.57" X 0.83" |
| UCMONCB018 | UCMOBCB018 | 19.06" X 25.06" | 18" X 24" | 17.33" X 23.33" | Landscape-Portrait | 6.172 lbs | 19.61" X 26.57" X 0.83" |
| UCMONCB022 | UCMOBCB022 | 23.06" X 29.06" | 22" X 28" | 21.33" X 27.33" | Landscape-Portrait | 8.598 lbs | 23.58" X 30.59" X 0.83" |
| UCMONCB023 | UCMOBCB023 | 21.06" X 31.06" | 20" X 30" | 19.33" X 29.33" | Landscape-Portrait | 8.377 lbs | 21.57" X 32.56" X 0.83" |
| UCMONCB024 | UCMOBCB024 | 25.06" X 37.06" | 24" X 36" | 23.33" X 35.33" | Landscape-Portrait | 12.125 lbs | 25.59" X 38.58" X 0.83" |
| UCMONCB034 | UCMOBCB034 | 31.06" X 41.06" | 30" X 40" | 29.33" X 39.33" | Landscape-Portrait | 20.502 lbs | 37.60" X 42.56" X 0.83" |

*W:Width H:Height D:Depth



Snap Frames





Slide-in Frames

- Counter Slide-in Frame
- Single Sided Slide-in Frame
- Double Sided Slide-in Frame



Counter Slide-in Frames



See movie at our website www.mtdisplays.com.tr



A new model of counter stand slide-in frame. Practical to change posters by sliding them in & out. Comes with 2 PET covers, an end plastic wick on the open side & double-sided tape at the bottom feet. This product is delivered in the landscape position for standard articles. An optional portrait position is available.

! Please clean the surface before applying the double sided tape for better application. Suitable for silk screen printing, maximum letter height is 0.35".



8.5" X 11" size portrait



8.5" X 11" size landscape

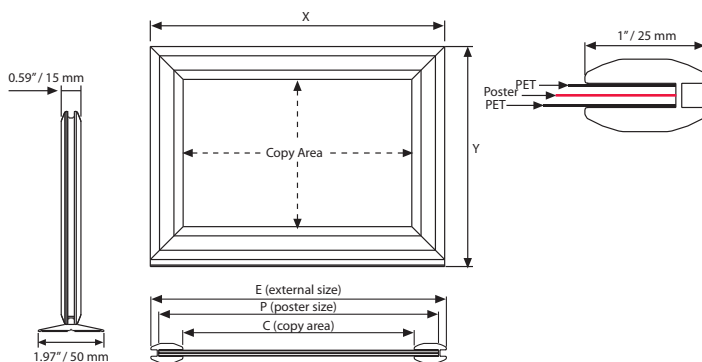
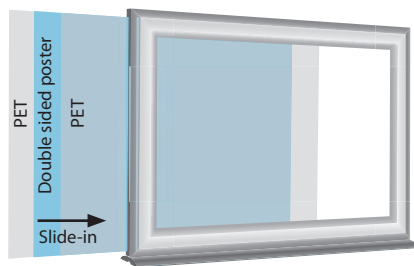

| MATERIAL : Silver anodized aluminum | | | | | WEIGHT | PACKING SIZE |
|-------------------------------------|-----------------|------------|----------------|-------------|--------------|-------------------------|
| PORTRAIT | EXTERNAL(x-y) | POSTER | COPY | DESCRIPTION | WITH PACKING | *W X H X D |
| UCA255B181 | 9.06" X 11.77" | 8.5" X 11" | 7.09" X 9.61" | Black | 1.720 lbs | 10.63" X 13.78" X 2.76" |
| UCA255N181 | 9.06" X 11.77" | 8.5" X 11" | 7.09" X 9.61" | Silver | 1.720 lbs | 10.63" X 13.78" X 2.76" |
| UCA255B117 | 11.57" X 17.76" | 11" X 17" | 9.61" X 15.59" | Black | 2.654 lbs | 12.20" X 18.11" X 2.36" |
| UCA255N117 | 11.57" X 17.76" | 11" X 17" | 9.61" X 15.59" | Silver | 2.654 lbs | 12.20" X 18.11" X 2.36" |

| MATERIAL : Silver anodized aluminum | | | | | WEIGHT | PACKING SIZE |
|-------------------------------------|-----------------|------------|----------------|-------------|--------------|-------------------------|
| LANDSCAPE | EXTERNAL(x-y) | POSTER | COPY | DESCRIPTION | WITH PACKING | *W X H X D |
| UCA255B281 | 11.57" X 9.25" | 8.5" X 11" | 9.61" X 7.09" | Black | 1.720 lbs | 10.63" X 13.78" X 2.76" |
| UCA255N281 | 11.57" X 9.25" | 8.5" X 11" | 9.61" X 7.09" | Silver | 1.720 lbs | 10.63" X 13.78" X 2.76" |
| UCA255B217 | 17.56" X 11.77" | 11" X 17" | 15.59" X 9.61" | Black | 2.654 lbs | 12.20" X 18.11" X 2.36" |
| UCA255N217 | 17.56" X 11.77" | 11" X 17" | 15.59" X 9.61" | Silver | 2.654 lbs | 12.20" X 18.11" X 2.36" |



*W:Width H: Height D: Depth

Single Sided Slide-in Frames



The same unit can be used both in landscape & portrait positions. A practical frame enabling you to easily change your posters by sliding the graphics in & out.

Each frame includes wall mounting accessories (4 screws & 4 plugs) Color options black & silver anodized.

! Suitable for silk screen printing, max. letter height is 0.51".

Color options

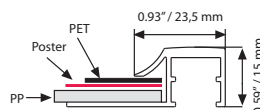
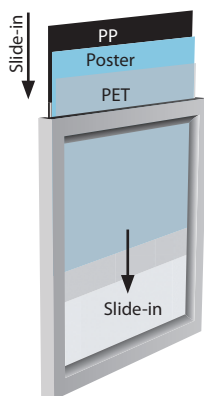
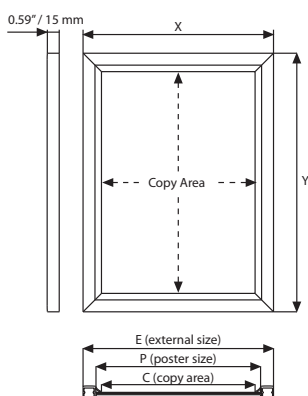
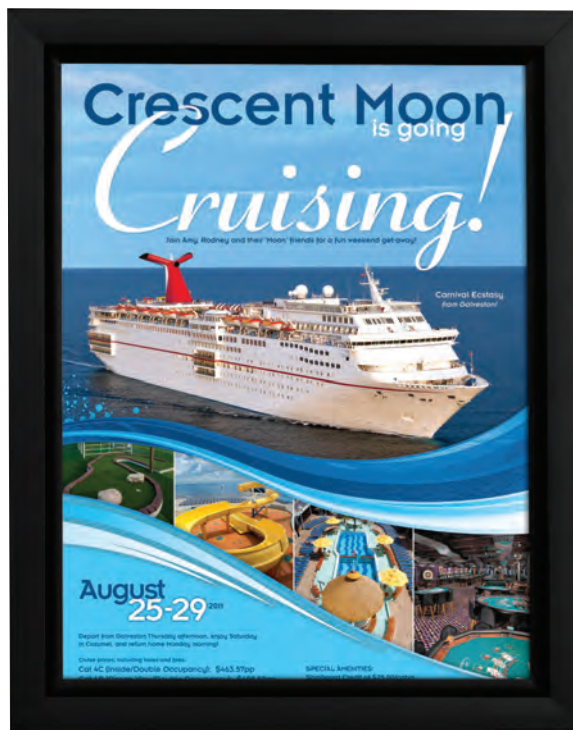

| MATERIAL : Silver anodized aluminum | | | | | WEIGHT | PACKING SIZE |
|-------------------------------------|------------|-----------------|------------|-----------------|--------------|-------------------------|
| SILVER | BLACK | EXTERNAL(x-y) | POSTER | COPY | WITH PACKING | *W X H X D |
| UCS245N181 | UCS245B181 | 9.80" X 12.32" | 8.5" X 11" | 7.95" X 10.47" | 1.102 lbs | 10.63" X 12.99" X 0.83" |
| UCS245N117 | UCS245B117 | 12.32" X 18.31" | 11" X 17" | 10.47" X 16.46" | 1.873 lbs | 12.99" X 18.90" X 0.83" |
| UCS245N118 | UCS245B118 | 19.33" X 25.31" | 18" X 24" | 17.48" X 23.46" | 2.645 lbs | 20.08" X 25.98" X 0.83" |
| UCS245N122 | UCS245B122 | 23.30" X 29.30" | 22" X 28" | 21.46" X 27.48" | 3.637 lbs | 24.02" X 30.31" X 0.83" |
| UCS245N124 | UCS245B124 | 25.30" X 37.30" | 24" X 36" | 23.45" X 35.45" | 4.850 lbs | 25.59" X 37.80" X 0.83" |

*W:Width H: Height D: Depth



Double Sided Slide-in Frames

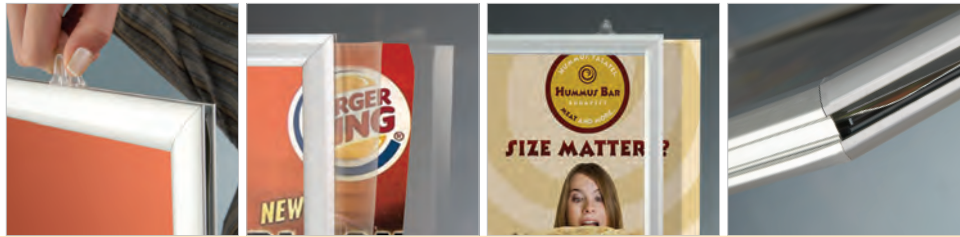

A practical frame enabling you to easily change your posters by sliding the graphics in & out. The double PET cover in the frame protects your poster from any sun and light effects.

Each frame includes 2 suspension hangers.

Moving hangers provide easy positioning for hanging.

Suitable for silk screen printing, max. letter height is 0.35".



8.5" X 11" size landscape

8.5" X 11" size portrait

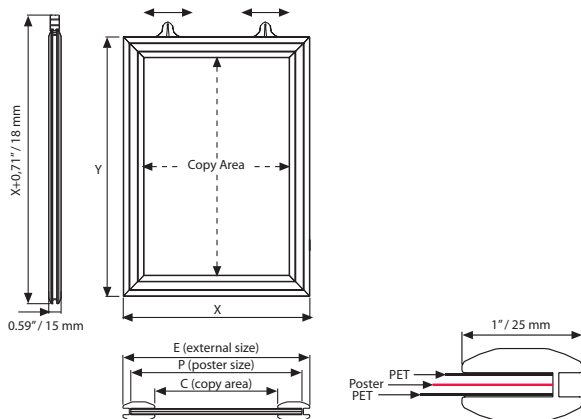

| MATERIAL : Silver anodized aluminum | | | | | | WEIGHT | PACKING SIZE |
|-------------------------------------|------------|-----------------|------------|-----------------|-------------|--------------|-------------------------|
| PORTRAIT | LANDSCAPE | EXTERNAL(x-y) | POSTER | COPY | DESCRIPTION | WITH PACKING | *W X H X D |
| UCS255N181 | UCS255N281 | 9.06" X 11.57" | 8.5" X 11" | 7.09" X 9.61" | Silver | 1.102 lbs | 10.63" X 12.99" X 0.83" |
| UCS255N117 | UCS255N217 | 11.57" X 17.56" | 11" X 17" | 9.61" X 15.59" | Silver | 1.873 lbs | 12.99" X 18.90" X 0.83" |
| UCS255N118 | UCS255N218 | 18.58" X 24.57" | 18" X 24" | 16.61" X 22.60" | Silver | 2.645 lbs | 20.08" X 25.98" X 0.83" |
| UCS255N122 | UCS255N222 | 22.56" X 28.58" | 22" X 28" | 20.59" X 26.61" | Silver | 3.637 lbs | 24.02" X 30.31" X 0.83" |
| UCS255B181 | UCS255B281 | 9.06" X 11.57" | 8.5" X 11" | 7.09" X 9.61" | Black | 1.102 lbs | 10.63" X 12.99" X 0.83" |
| UCS255B117 | UCS255B217 | 11.57" X 17.56" | 11" X 17" | 9.61" X 15.59" | Black | 1.873 lbs | 12.99" X 18.90" X 0.83" |
| UCS255B118 | UCS255B218 | 18.58" X 24.57" | 18" X 24" | 16.61" X 22.60" | Black | 2.645 lbs | 20.08" X 25.98" X 0.83" |
| UCS255B122 | UCS255B222 | 22.56" X 28.58" | 22" X 28" | 20.59" X 26.61" | Black | 3.637 lbs | 24.02" X 30.31" X 0.83" |

*W:Width H: Height D: Depth





Weatherproof Frames

- Lockable Weatherproof Frame
- Weatherproof Frame 1" / 25mm
- Weatherproof Frame 1.38" / 35mm



Lockable Weatherproof Frames



The four sides of the lockable frame open sequentially. The last profile is held in place with a screw on top that can be opened with its key. This system ensures your poster is never accessed by unauthorized third parties. Suitable for outdoor use. The product has water drainage slots (for details see assembly sheet). Anti-glare / anti UV poster cover sheet.

Each frame includes an allen key to open the locked profile. Each frame includes wall mounting accessories (4 screws & 4 plugs).

"Optional hangers" permit easy mounting.

Suitable for silk screen printing. max. letter height is 0.63". Please use the pull sticker to take off the cover. Please place the poster inside the water wick around the inner frame.



Patent Pending
TR 2006 06254
PCT/TR06/000064



UYAA011010
V hanger

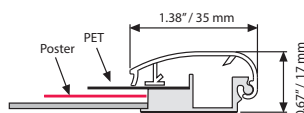
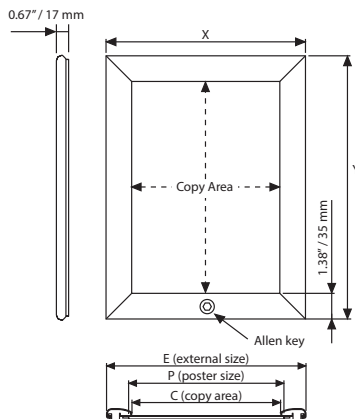

| MATERIAL : Silver anodized aluminum | | | | | WEIGHT | PACKING SIZE |
|-------------------------------------|------------|-----------------|-----------|-----------------|--------------|-------------------------|
| SILVER | BLACK | EXTERNAL (x-y) | POSTER | COPY | WITH PACKING | *W X H X D |
| UCV355N023 | UCV355B023 | 22.60" X 32.60" | 20" X 30" | 19.84" X 29.84" | 4.629 lbs | 22.83" X 32.83" X 0.91" |
| UCV355N034 | UCV355B034 | 32.60" X 42.60" | 30" X 40" | 29.84" X 39.84" | 9.700 lbs | 32.83" X 42.83" X 0.91" |
| UCV355N046 | UCV355B046 | 42.60" X 62.60" | 40" X 60" | 39.84" X 59.84" | 18.077 lbs | 42.83" X 62.99" X 0.91" |
| UCV355N022 | UCV355B022 | 24.60" X 30.60" | 22" X 28" | 21.84" X 27.84" | 5.643 lbs | 24.41" X 30.71" X 1.22" |
| UCV355N024 | UCV355B024 | 26.60" X 38.60" | 24" X 36" | 23.84" X 35.84" | 7.605 lbs | 26.77" X 38.58" X 1.22" |



* W:Width H: Height D: Depth

Weatherproof Frames

1" / 25 mm



- Suitable for outdoor use.
- Ideal for posters of every size.
- Natural silver anodized and black color available.
- Mitered corners.
- There are water drainage slots on the product (for details see assembly sheet).
- Anti-glare / anti UV poster cover sheet.

Each frame includes wall mounting accessories (4 screws & 4 plugs).

"Optional hangers" permit easy mounting.

Please use the pull sticker to take off the cover. Please place the poster inside the water wick around the poster area of the frame.



Patent Pending
TR 2006 06254
PCT/TR 2006/000064

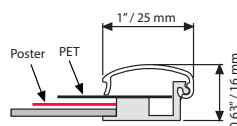
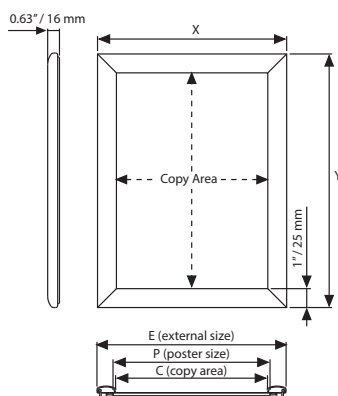

| MATERIAL : Silver anodized aluminum | | | | | WEIGHT | PACKING SIZE |
|-------------------------------------|------------|-----------------|-----------|-----------------|--------------|-------------------------|
| SILVER | BLACK | EXTERNAL (x-y) | POSTER | COPY | WITH PACKING | *W X H X D |
| UCH255N018 | UCH255B018 | 19.88" X 25.94" | 18" X 24" | 17.87" X 23.94" | 3.527 lbs | 20.47" X 26.38" X 0.91" |
| UCH255N022 | UCH255B022 | 23.94" X 29.92" | 22" X 28" | 21.93" X 27.91" | 4.850 lbs | 24.41" X 30.71" X 1.22" |
| UCH255N024 | UCH255B024 | 25.94" X 37.91" | 24" X 36" | 23.94" X 35.91" | 5.401 lbs | 26.77" X 38.58" X 1.22" |



*W:Width H: Height D: Depth

Weatherproof Frames

1.38" / 35 mm

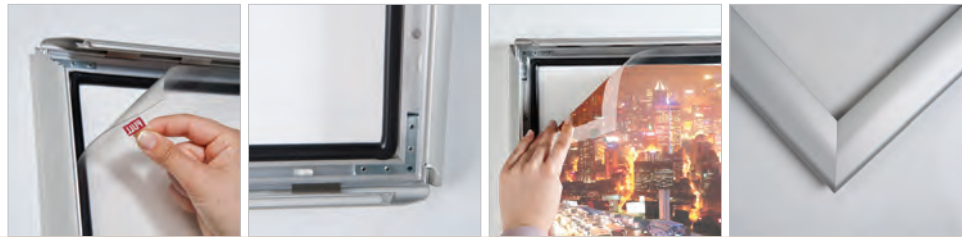

- Suitable for use in outdoor conditions.
- Ideal for posters of every size.
- Natural silver anodized and black color available.
- Mitered corners.
- There are water drainage slots on the product (for details see assembly sheet).
- Anti-glare / anti UV poster cover sheet.

 Each frame includes wall mounting accessories (4 screws & 4 plugs).

 "Optional hangers" permit easy mounting.

 Please use the pull sticker to take off the cover. Please place the poster inside the water wick around the poster area of the frame.



Patent Pending
TR 2006 06254
PCT/TR 2006/000064

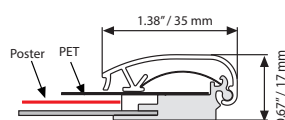
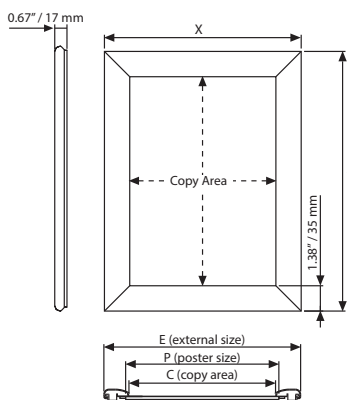

| MATERIAL : Silver anodized aluminum | | | | | WEIGHT | PACKING SIZE |
|-------------------------------------|------------|-----------------|-----------|-----------------|--------------|-------------------------|
| SILVER | BLACK | EXTERNAL (x-y) | POSTER | COPY | WITH PACKING | *W X H X D |
| UCH355N018 | UCH355B018 | 20.47" X 26.46" | 18" X 24" | 17.72" X 23.70" | 4.078 lbs | 21.65" X 27.17" X 1.22" |
| UCH355N022 | UCH355B022 | 24.45" X 30.47" | 22" X 28" | 21.69" X 27.72" | 5.511 lbs | 25.59" X 31.50" X 1.22" |
| UCH355N024 | UCH355B024 | 26.46" X 38.46" | 24" X 36" | 23.70" X 35.71" | 7.495 lbs | 27.56" X 39.37" X 1.22" |

*W:Width H: Height D: Depth





Poster Hangers

- Poster Snaps
- Banner Hangers
- Poster Fast
- Stretch Frames
- Poster Clamps
- Outdoor Flap Grippers



Poster Snaps 1.02" / 26mm



See movie at our website www.mtdisplays.com.tr



One set includes the upper and the bottom profiles with the end caps on both profiles and the hangers on the top profile. Improved rubber foam for poster suspension.

Single packed as a set in plastic bags.

No tool assembly.

Moving hangers permit easy assembly. Suitable for silk screen printing, max. letter height is 0.39".

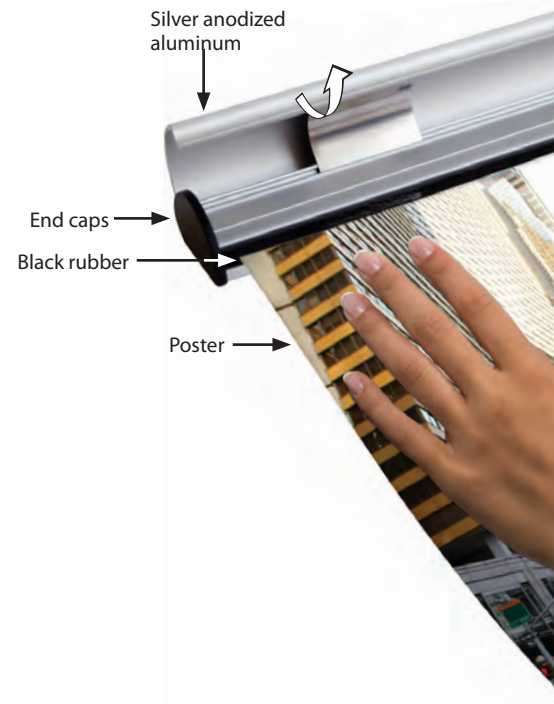

Patent Pending
TR 2005 01301

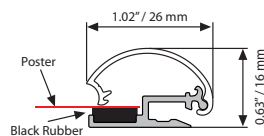
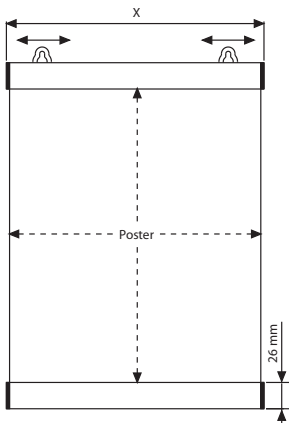

| MATERIAL : Silver anodized aluminum | | | WEIGHT | PACKING SIZE |
|-------------------------------------|--------------|--------|--------------|------------------------|
| ARTICLE | EXTERNAL (x) | POSTER | WITH PACKING | *W X H X D |
| UPT26SN458 | 18.19" | 18" | 0.727 lbs | 2.36" X 20.47" X 1.77" |
| UPT26SN559 | 22.17" | 22" | 0.903 lbs | 2.36" X 24.80" X 1.77" |
| UPT26SN610 | 24.17" | 24" | 0.727 lbs | 2.36" X 26.77" X 1.77" |
| UPT26SN686 | 27.17" | 27" | 1.102 lbs | 2.36" X 29.92" X 1.77" |
| UPT26SN762 | 30.16" | 30" | 1.212 lbs | 2.36" X 32.68" X 1.77" |
| UPT26SN915 | 36.18" | 36" | 1.256 lbs | 2.36" X 38.98" X 1.77" |
| UPT26SN122 | 48.19" | 48" | 1.807 lbs | 2.36" X 50" X 1.77" |
| UPT26SN182 | 72.17" | 72" | 2.755 lbs | 2.36" X 74.80" X 1.77" |



*W:Width H: Height D: Depth

Banner Hangers

1" / 25 mm



A newly created series of poster clamps offers competitive solutions. Suitable for posters in thickness 50 of microns / 500 microns. One set includes end caps on both profiles and hangers on the top profile.

 Single packed as set in plastic bags. Turning end caps help to slide the poster in.

 No tool assembly. Hangers are suitable for wall mounting and ceiling suspension. Moving hangers allow easy assembly.

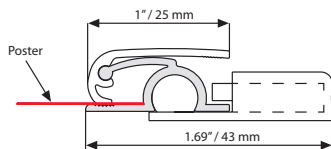
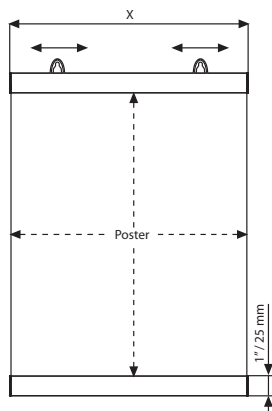

| MATERIAL : Silver anodized aluminum | | | WEIGHT | PACKING SIZE |
|-------------------------------------|--------------|--------|--------------|------------------------|
| ARTICLE | EXTERNAL (x) | POSTER | WITH PACKING | *W X H X D |
| UPC10SN610 | 24.17" | 24" | 1.124 lbs | 2.36" X 26.77" X 1.77" |
| UPC10SN762 | 30.16" | 30" | 1.344 lbs | 2.36" X 32.68" X 1.77" |
| UPC10SN915 | 36.18" | 36" | 1.543 lbs | 2.36" X 38.98" X 1.77" |
| UPC10SN122 | 48.19" | 48" | 2.182 lbs | 2.36" X 50" X 1.77" |
| UPC10SN183 | 72.17" | 72" | 3.306 lbs | 2.36" X 74.80" X 1.77" |



* W:Width H: Height D: Depth



Poster Fast



See movie at our website www.mtdisplays.com.tr



Suitable for heavier and bigger posters in thickness 10 of microns / 500 microns. A double-sided poster holder. One set includes end caps on both profiles and hangers on the top profile. The product is supplied with 1.57" clear co-extrusion components inside which hold the poster.

-  Single packed as a set in plastic bags.
-  No tool assembly. Turning end caps help to slide the poster in. Moving hangers permit easy assembly. Hangers are suitable for wall mounting & ceiling suspension.
-  Suitable for silk screen printing, max. letter height is 0.39"



Double sided

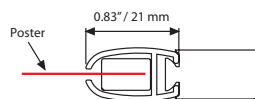
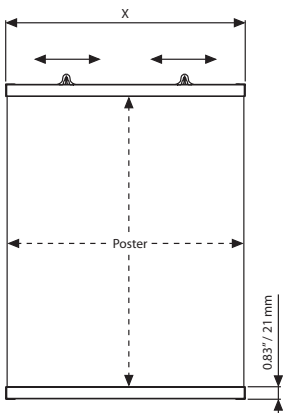

| MATERIAL : Silver anodized aluminum | | | WEIGHT | PACKING SIZE |
|-------------------------------------|--------------|--------|--------------|------------------------|
| ARTICLE | EXTERNAL (x) | POSTER | WITH PACKING | *W X H X D |
| UPF21SN061 | 24.21" | 24" | 0.749 lbs | 2.36" X 26.77" X 1.77" |
| UPF21SN762 | 30.20" | 30" | 0.947 lbs | 2.36" X 32.68" X 1.77" |
| UPF21SN915 | 36.22" | 36" | 1.146 lbs | 2.36" X 38.98" X 1.77" |
| UPF21SN122 | 48.23" | 48" | 1.521 lbs | 2.36" X 50" X 1.77" |
| UPF21SN182 | 72.20" | 72" | 2.259 lbs | 2.36" X 74.80" X 1.77" |

*W:Width H: Height D: Depth



Stretch Frames



See movie at our website www.mtdisplays.com.tr



A lightweight frame that stretches the poster from 4 corners. The poster can be easily changed with the help of plastic clips. It is available in standard anodized silver. Other colors are available upon request. Two plastic hangers for both wall mounting and ceiling suspension are included. The plastic clips stretched from the corners place the poster in the center.

Single packed unassembled in carton boxes with an easy-to-understand instruction sheet. Each pack includes 4 clips & 2 hanger.

Hangers are suitable for wall mounting & ceiling suspension.

Recommended poster material is paper, any heavier material such as vinyl or textile may damage the springs at the corner.
Suitable for silk screen printing, max. letter height is 0.31"

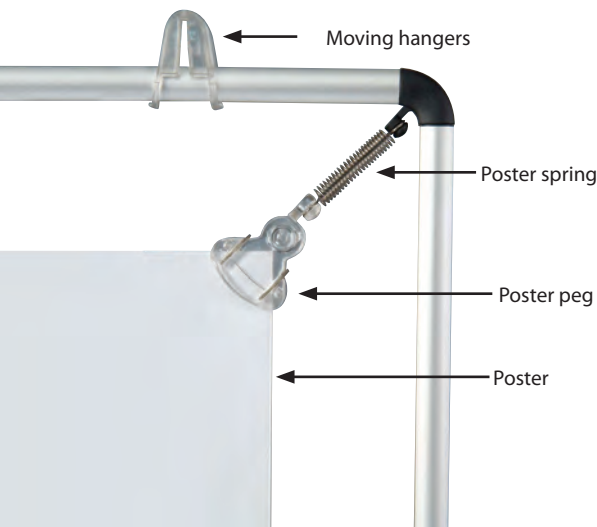

Stretch Frame packing

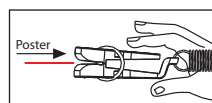
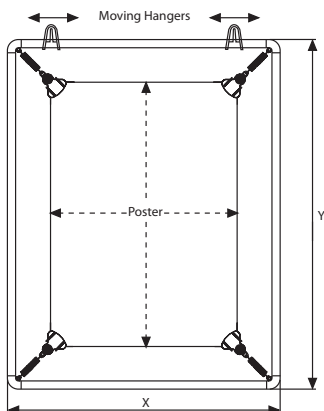

| MATERIAL : Silver anodized aluminum | | WEIGHT | PACKING SIZE |
|-------------------------------------|-----------------|--------------|-----------------------|
| ARTICLE | EXTERNAL (x-y) | WITH PACKING | *W X H X D |
| UPSCN00081 | 12.44" X 14.96" | 0.242 lbs | 2.17" X 1.69" X 1.18" |
| UPSCN00017 | 14.96" X 20.94" | 0.473 lbs | 2.17" X 2.13" X 1.18" |
| UPSCN00018 | 21.97" X 27.95" | 0.595 lbs | 2.17" X 2.83" X 1.18" |
| UPSCN00022 | 25.94" X 31.97" | 0.639 lbs | 2.17" X 3.27" X 1.18" |

* W:Width H: Height D: Depth



Poster Clamps

1.30" / 30 mm



See movie at our website www.mtdisplays.com.tr



Suitable for heavier and bigger posters in thickness of 50 microns / 500 microns. One set includes the end caps on both profiles and the hangers on the top profile.

Single packed as set in plastic bags. Turning end caps help to slide the poster in.

No tool assembly. Hangers are suitable for wall mounting & ceiling suspension.

Moving hangers permit easy assembly. Suitable for silk screen printing, max. letter height is 0.71".

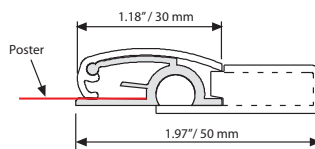
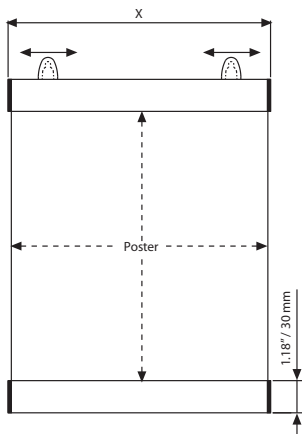

| MATERIAL : Silver anodized aluminum | | | WEIGHT | PACKING SIZE |
|-------------------------------------|--------------|--------|--------------|------------------------|
| ARTICLE | EXTERNAL (x) | POSTER | WITH PACKING | *W X H X D |
| UPC00SN610 | 24.25" | 24" | 0.903 lbs | 2.36" X 25.98" X 1.77" |
| UPC00SN762 | 30.24" | 30" | 1.124 lbs | 2.36" X 32.28" X 1.77" |
| UPC00SN915 | 36.26" | 36" | 1.366 lbs | 2.36" X 37.80" X 1.77" |
| UPC00SN122 | 48.27" | 48" | 1.807 lbs | 2.36" X 74.41" X 1.77" |
| UPC00SN183 | 72.24" | 72" | 2.711 lbs | 2.36" X 50.39" X 1.77" |

*W:Width H: Height D: Depth





Showboards

- Poster Showboards
- Universal Poster Showboards



Poster Showboards





See movie at our website www.mtdisplays.com.tr



Ideal for displaying individual posters and single sheet menus. Suitable for outdoor use. The cover can be opened up to 90 degrees. Each unit includes mounting screws and plugs. The profile width is 1.77" and the depth of the case is 1.18".

 Each product includes 1 key set.

 Each unit is supplied with a free set of clear plastic pegs to hold the poster. 2 stop arms at each end help to keep the cover door open.

 Please discard the protective film on the unit before use.

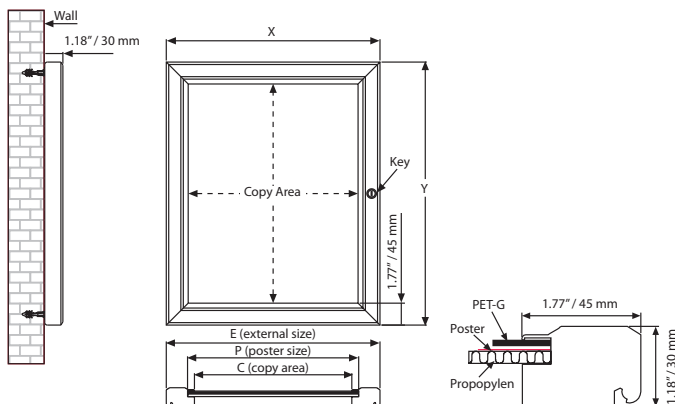

| MATERIAL : Silver anodized aluminum | | | | | WEIGHT | PACKING SIZE |
|-------------------------------------|-----------------|-----------|-----------------|-----|--------------|-------------------------|
| ARTICLE | EXTERNAL (x-y) | POSTER | COPY | KEY | WITH PACKING | *W X H X D |
| USBN000022 | 24.76" X 30.76" | 22" X 28" | 21.21" X 27.21" | 1 | 10.471 lbs | 25.79" X 31.69" X 2.17" |
| USBN000024 | 26.76" X 38.76" | 24" X 36" | 23.21" X 35.21" | 1 | 12.345 lbs | 27.95" X 39.76" X 2.17" |
| USBN000036 | 38.76" X 50.76" | 36" X 48" | 35.21" X 47.21" | 2 | 21.605 lbs | 39.96" X 51.77" X 2.17" |

*W:Width H: Height D: Depth





Universal Poster Showboards



Slim and Sleek!

The lockable poster display case, Universal Showboard is designed to display printed posters in different options. When seen on the wall, it looks like a snap frame with slim case which is 1.06" deep, has a 1.18" profile and hidden lock on the side. It is suitable for public places or outdoor use under a shelter. It is easy to change the poster with hinged door and clips holding the poster.

 Each product includes 1 key set.

 Each unit is supplied with a free set of clear plastic pegs to hold the poster. 2 stop arms at each end help to keep the cover door open.

 Please discard the protective film on the unit before use.

1.06" / 27 mm thickness



Clear plastic pegs hold the poster

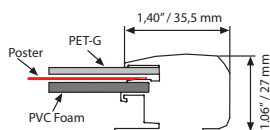
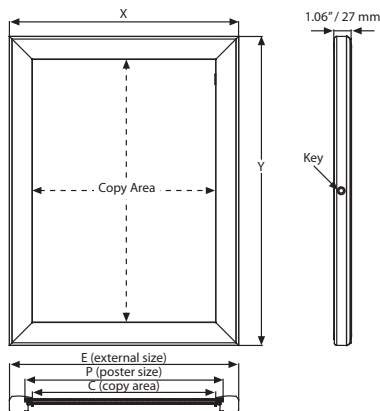
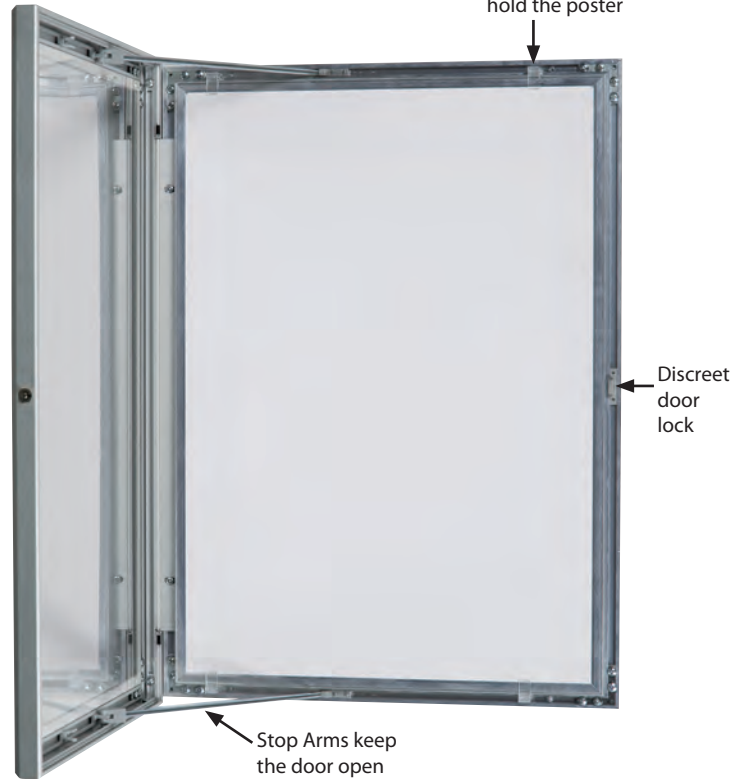

| MATERIAL : Silver anodized aluminum | | | | | WEIGHT | PACKING SIZE |
|-------------------------------------|-----------------|-----------|-----------------|-----|--------------|-------------------------|
| ARTICLE | EXTERNAL (x-y) | POSTER | COPY | KEY | WITH PACKING | *W X H X D |
| USBNU00018 | 20.24" X 26.27" | 18" X 24" | 17.45" X 23.45" | 2 | 9.920 lbs | 20.87" X 26.97" X 1.57" |
| USBNU00022 | 24.24" X 30.24" | 22" X 28" | 21.45" X 27.45" | 2 | 12.125 lbs | 24.80" X 30.91" X 1.57" |
| USBNU00024 | 26.27" X 38.24" | 24" X 36" | 23.45" X 35.45" | 2 | 14.330 lbs | 26.97" X 38.98" X 1.57" |
| USBNU00036 | 38.24" X 50.24" | 36" X 48" | 35.45" X 47.45" | 2 | 22.046 lbs | 38.98" X 50.59" X 1.57" |

* W:Width H: Height D: Depth



Universal Poster Showboards

115th Anniversary
Srinakharinwirot University
College of Good Health

Botox

บอท็อกซ์

บอท็อกซ์ ช่วยลดริ้วรอย ชะลอวัยด้วย Botox
ลดริ้วรอย รอยยิ้ม รอยคล้ำริ้วรอยหน้าผาก

บอท็อกซ์ ช่วยลดริ้วรอย ชะลอวัยด้วย Botox
ลดริ้วรอย รอยยิ้ม รอยคล้ำริ้วรอยหน้าผาก

Botox, Miracle of Juvenescence Look

Influences on our skin such as environment, pollution, age and emotional expression cause wrinkles. Botox can help reduce wrinkles and return a youthful appearance around forehead, eyes, glabella, chin and cheek. Botox treatment results in a beautiful appearance last up to 3-6 months.

ชะลอวัยด้วย บอท็อกซ์ !
Create your own beauty, at the expense of your skin.

7,500 บาท

เฉพาะวันที่ 1 - 31 กรกฎาคม 2553
only from 1 - 31 July 2013

For more information, please visit
Dermatology and Beauty Centre
01-456-2700 ext. 1030, 1031

01-456-2700
01-456-2700 ext. 1030, 1031

01-456-2700 ext. 1030, 1031

01-456-2700 ext. 1030, 1031





Banner Stands

- Cross Banners
- Quick Banners
- Newage Quick Banners
- Retractable Roll Up Stands
- Smart Roll Banners
- Easy Swaps
- Poster Traps
- Eco Roll Banners
- Super Eco Roll Banners

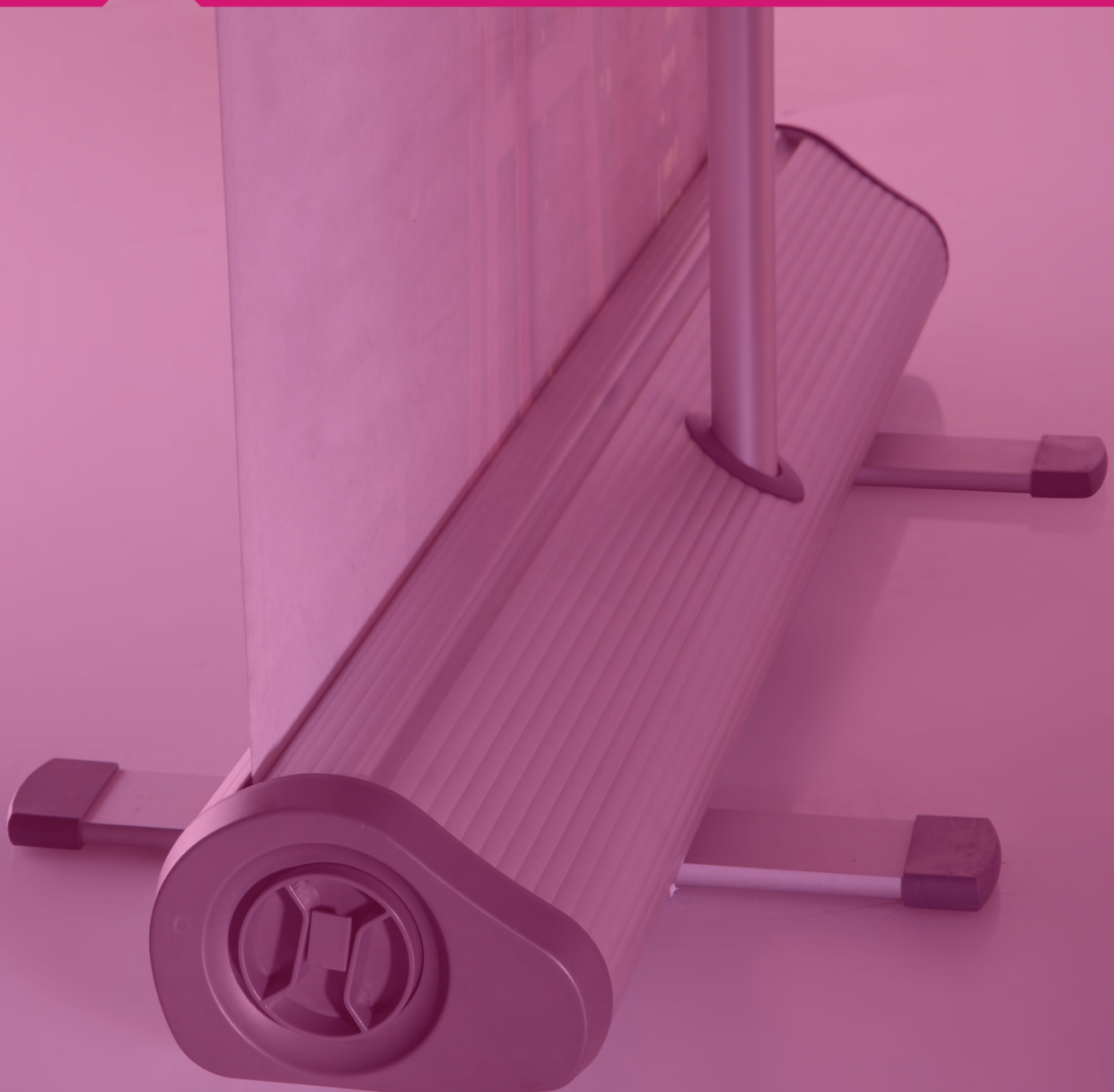

Cross Banners



See movie at our website www.mtdisplaysllc.com



Cross Single banner is a new style of banner systems. It rotates 360 degrees. The height of the poster is flexible, can be adjusted up to 6.56 ft. Powder coated steel feet provides stability to the product. It gets attention of customers rotating around easily.

Product comes unassembled, packed with an easy to understand instruction sheet.

Recommended up to 39.37" in poster size. Stainless aluminum legs are suitable for public spaces.

Black carry bag should be ordered separately.

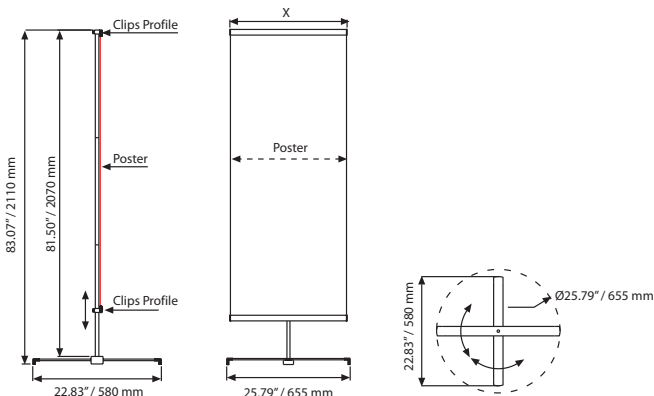
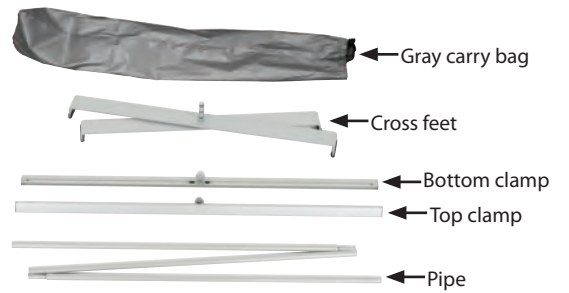
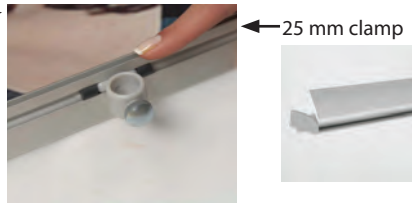

| MATERIAL : Silver anodized aluminum | | | WEIGHT | PACKING SIZE (10 Pcs) |
|-------------------------------------|----------------------|--------|--------------|------------------------|
| ARTICLE | POSTER | X | WITH PACKING | *W X H X D |
| USBC000N62 | 23.62" X max. 78.74" | 23.86" | 5.930 lbs | 2.95" X 33.86" X 4.13" |
| USBC000N72 | 27.56" X max. 78.74" | 27.80" | 6.062 lbs | 2.95" X 33.86" X 4.13" |
| USBC000N82 | 31.50" X max. 78.74" | 31.73" | 6.261 lbs | 2.95" X 33.86" X 4.13" |

*W:Width H: Height D: Depth



Quick Banners



See movie at our website www.mtdisplaysllc.com



Quick banner displays are a flexible and mobile poster designed as a practical set that can be carried to conventions or exhibitions within its bag.

Packed with an easy to understand instruction sheet.



Single Sided



Double Sided

Patent Pending
TR 2005 01772

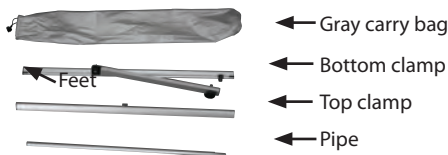

Single Sided

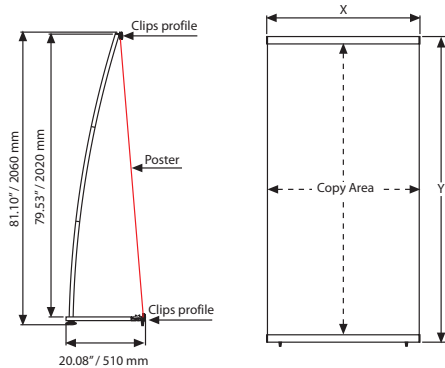

Double Sided

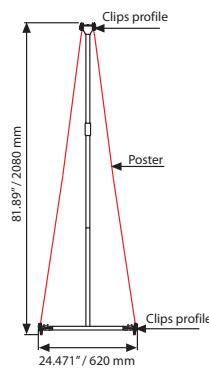

| BAG | | PACKING SIZE |
|------------|--------|------------------------|
| ARTICLE | MODEL | *W X H X D |
| UYUP066000 | 31.50" | 6.30" X 33.86" X 6.30" |
| UYUP067000 | 39.37" | 6.30" X 41.73" X 6.30" |

| MATERIAL : Silver anodized aluminum | | | | WEIGHT | PACKING SIZE |
|-------------------------------------|-----------------|-----------------|-----------------|--------------|------------------------|
| ARTICLE | EXTERNAL (x-y) | POSTER | COPY | WITH PACKING | *W X H X D |
| UQB0C00N72 | 27.80" X 79.92" | 27.56" X 78.74" | 27.56" X 77.56" | 5.489 lbs | 2.95" X 33.86" X 4.13" |
| UQB0C00N82 | 31.73" X 79.92" | 31.50" X 78.74" | 31.50" X 77.56" | 5.842 lbs | 2.95" X 33.86" X 4.13" |
| UQB0C00N92 | 35.67" X 79.92" | 35.43" X 78.74" | 35.43" X 77.56" | 6.382 lbs | 2.95" X 41.73" X 4.13" |
| UQB0C00N12 | 39.61" X 79.92" | 39.37" X 78.74" | 39.37" X 77.56" | 6.746 lbs | 2.95" X 41.73" X 4.13" |

* W:Width H: Height D: Depth



| MATERIAL : Silver anodized aluminum | | | | WEIGHT | PACKING SIZE |
|-------------------------------------|-----------------|-----------------|-----------------|--------------|------------------------|
| ARTICLE | EXTERNAL (x-y) | POSTER | COPY | WITH PACKING | *W X H X D |
| UQB0T00N72 | 27.80" X 79.92" | 27.56" X 78.74" | 27.56" X 77.56" | 3.703 lbs | 2.95" X 33.86" X 4.13" |
| UQB0T00N82 | 31.73" X 79.92" | 31.50" X 78.74" | 31.50" X 77.56" | 3.924 lbs | 2.95" X 33.86" X 4.13" |
| UQB0T00N92 | 35.67" X 79.92" | 35.43" X 78.74" | 35.43" X 77.56" | 4.276 lbs | 2.95" X 41.73" X 4.13" |
| UQB0T00N12 | 39.61" X 79.92" | 39.37" X 78.74" | 39.37" X 77.56" | 4.453 lbs | 2.95" X 41.73" X 4.13" |

* W:Width H: Height D: Depth



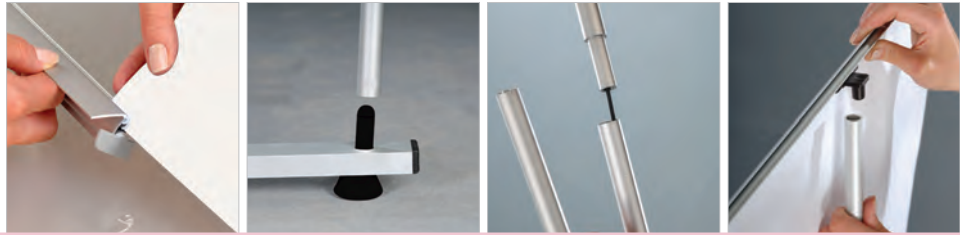

Newage Quick Banners



Newage Quick Banner displays offer competitive solutions. Suitable to hold banners in thickness of 50 microns / 500 microns. New Age Quick Banner is a flexible and mobile set that can be carried to conventions or exhibitions within its bag.

 Turning end caps help to slide the poster in.

 No tool assembly.

 Product is not recommended for special sizes wider than 39.37" and longer than 78.74". Black carry bag should be ordered extra.

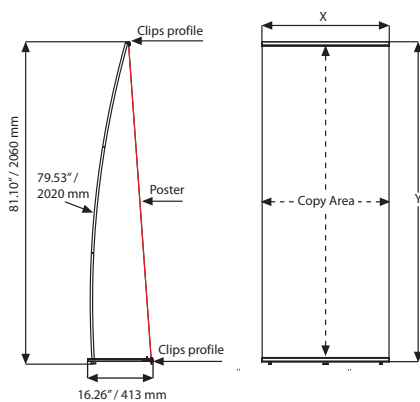
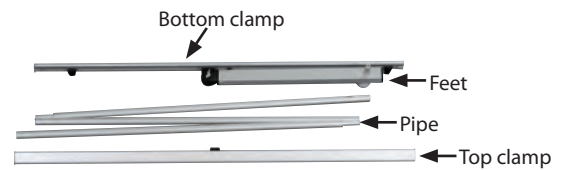

| MATERIAL : Silver anodized aluminum | | | | WEIGHT | PACKING SIZE |
|-------------------------------------|-----------------|-----------------|-----------------|--------------|------------------------|
| ARTICLE | EXTERNAL (x-y) | POSTER | COPY | WITH PACKING | *W X H X D |
| UQBETOON62 | 23.74" X 79.92" | 23.62" X 78.74" | 23.62" X 77.56" | 2.601 lbs | 2.95" X 33.86" X 4.13" |
| UQBETOON72 | 27.68" X 79.92" | 27.56" X 78.74" | 27.56" X 77.56" | 2.733 lbs | 2.95" X 33.86" X 4.13" |
| UQBETOON82 | 31.61" X 79.92" | 31.50" X 78.74" | 31.50" X 77.56" | 2.866 lbs | 2.95" X 33.86" X 4.13" |
| UQBETOON92 | 35.55" X 79.92" | 35.43" X 78.74" | 35.43" X 77.56" | 3.196 lbs | 2.95" X 41.73" X 4.13" |
| UQBETOON12 | 39.49" X 79.92" | 39.37" X 78.74" | 39.37" X 77.56" | 3.351 lbs | 2.95" X 41.73" X 4.13" |

*W:Width H: Height D: Depth



Retractable Roll up Banners

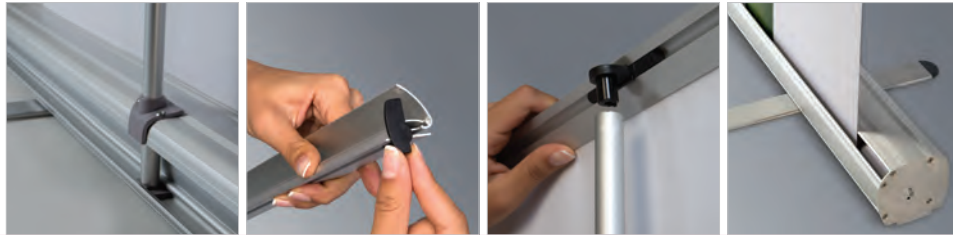

The rolling cylinder comes ready at the point available to place in the work. After the placement of the art work, the cylinder runs immediately once the pin on one end is off. The rolling cylinder can be set up and stretched to the required tightness.

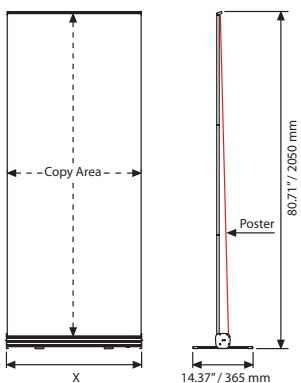

| MATERIAL : Silver anodized aluminum | | | | WEIGHT | PACKING SIZE |
|-------------------------------------|-----------------|-----------------|--------|--------------|------------------------|
| ARTICLE | POSTER | COPY | X | WITH PACKING | *W X H X D |
| TWKSRS1085 | 33.46" X 78.74" | 33.46" X 77.56" | 34.01" | 5.985 lbs | 4.92" X 33.86" X 4.92" |



*W:Width H: Height D: Depth



Smart Roll Banner Single Sided



See movie at our website www.mtdisplaysllc.com



With the latest revision on Smart Roll Banner, M&T concentrated on both design and functionality features. Pipe fixation and improved end caps provide a more stable product and the new revised design gives a more elegant look to the product. The aluminum body is silver anodized stands at min 39.37", max 90.55" height and has a unique telescopic pipe.

-  Product comes ready to roll-up into black carry bag.
-  Has unique adjustable telescopic pipe.
-  Please do not loosen the mechanism when the printing is assembled on the top position.



Improved design



Stable pipe fixation

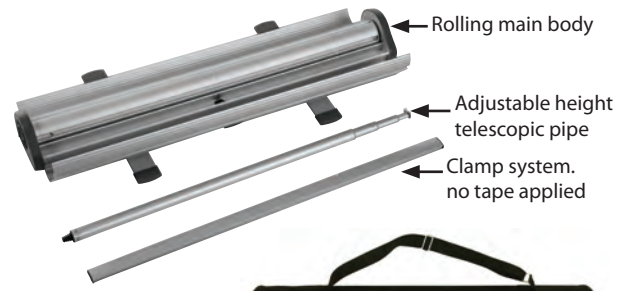

Rolling main body

Adjustable height telescopic pipe

Clamp system. no tape applied



Transport bag

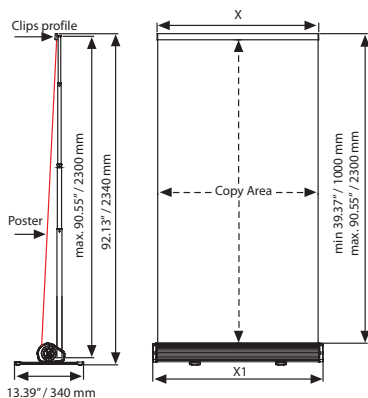

Telescopic Pipe

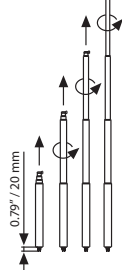

| MATERIAL : Silver anodized aluminum | | | WEIGHT | PACKING SIZE |
|-------------------------------------|--------|--------|--------------|------------------------|
| ARTICLE | X1 | POSTER | WITH PACKING | *W X H X D |
| URBSTOON82 | 33.46" | 31.50" | 14.550 lbs | 7.09" X 35.83" X 7.09" |
| URBSTOON92 | 37.40" | 35.43" | 15.873 lbs | 7.09" X 44.09" X 7.09" |
| URBSTOON12 | 41.34" | 39.37" | 16.975 lbs | 7.09" X 44.09" X 7.09" |



*W:Width H: Height D: Depth

Easy Swaps



See movie at our website www.mtdisplaysllc.com



Economical and easy to use product. You just put in your PVC foam poster with 0.20" to 0.39" thickness and adjust the nut from the bottom part of the aluminum box. It can be used in all indoor areas such as schools, seminars, restaurants, showrooms, exhibition areas, malls and everywhere else.

Packed with an easy to understand instruction sheet.

To change the poster boards, please loosen the nut under the aluminum box.

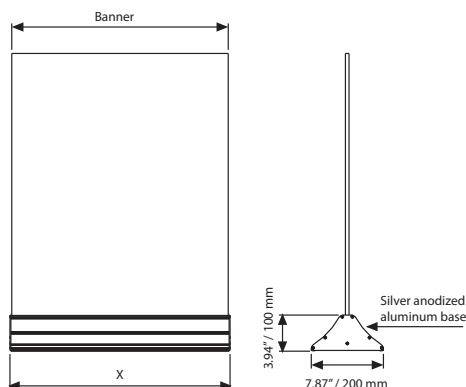

| MATERIAL : Silver anodized aluminum | | | WEIGHT | PACKING SIZE |
|-------------------------------------|--------------|--------|--------------|------------------------|
| ARTICLE | EXTERNAL (x) | POSTER | WITH PACKING | *W X H X D |
| UMS0100300 | 12.20" | 11.81" | 4.409 lbs | 8.66" X 13.39" X 4.61" |
| UMS0100600 | 24.02" | 23.62" | 6.834 lbs | 8.66" X 25.20" X 4.61" |
| UMS0100800 | 31.89" | 31.50" | 11.816 lbs | 8.66" X 33.07" X 4.61" |
| UMS0100900 | 35.83" | 35.43" | 13.293 lbs | 8.66" X 37.01" X 4.61" |
| UMS0101000 | 39.76" | 39.37" | 14.770 lbs | 8.66" X 40.94" X 4.61" |
| UMS0101200 | 47.64" | 47.24" | 17.725 lbs | 8.66" X 48.82" X 4.61" |
| UMS0101500 | 59.45" | 59.06" | 22.156 lbs | 8.66" X 60.63" X 4.61" |

* W:Width H: Height D: Depth



Poster Traps



See movie at our website www.mtdisplaysllc.com



The system is mainly based on screwing the 2 pieces of the bases to each other to stand the poster still. Adjustable thickness of poster. The maximum height of poster is 59.06". Base is double sided. Suitable for all areas.



Packed with an easy to understand instruction sheet.



The holes on the substrate should be 0.35" diameter

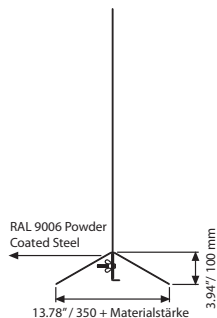
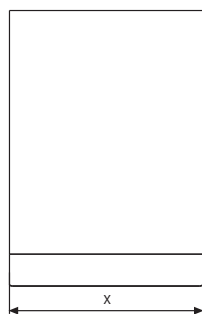

Tolerance for the holes

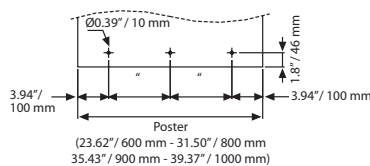
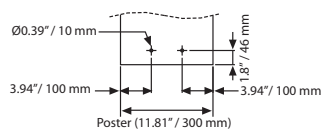

| MATERIAL : Silver anodized aluminum | | | WEIGHT | PACKING SIZE |
|-------------------------------------|--------------|--------|--------------|------------------------|
| ARTICLE | EXTERNAL (x) | POSTER | WITH PACKING | *W X H X D |
| UMS0000300 | 11.81" | 11.81" | 7.627 lbs | 8.07" X 12.99" X 4.61" |
| UMS0000600 | 23.62" | 23.62" | 13.778 lbs | 8.07" X 24.80" X 4.61" |
| UMS0000800 | 31.50" | 31.50" | 17.857 lbs | 8.07" X 32.68" X 4.61" |
| UMS0000900 | 35.43" | 35.43" | 20.502 lbs | 8.07" X 36.61" X 4.61" |
| UMS0001000 | 39.37" | 39.37" | 22.928 lbs | 8.07" X 40.55" X 4.61" |



* W:Width H: Height D: Depth



Eco Roll Banners



See movie at our website www.mtdisplaysllc.com



The rolling cylinder comes ready at the point available to place in the art work. After the placement of the art work, the cylinder runs immediately once the pin on one end is off. The rolling cylinder can be set up and stretched in the required tightness.

-  Product comes unassembled, packed with an easy-to-understand instruction sheet.
-  Stainless aluminum legs are suitable for public spaces.
-  Black carry bag should be ordered separately.

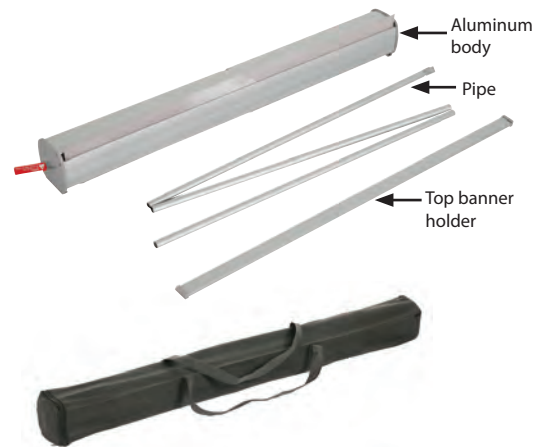

Bag for Eco Roll Banner

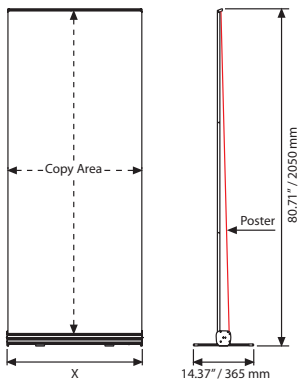

| MATERIAL : Silver anodised aluminium | | | | WEIGHT | PACKING SIZE |
|--------------------------------------|-----------------|-----------------|--------|--------------|------------------------|
| ARTICLE | POSTER | COPY | X | WITH PACKING | *W X H X D |
| URBETO0N82 | 31.50" X 78.75" | 31.50" X 77.56" | 32.28" | 5.423 lbs | 4.33" X 33.86" X 4.33" |
| URBETO0N12 | 39.37" X 78.75" | 39.37" X 77.56" | 40.16" | 6.393 lbs | 4.33" X 41.73" X 4.33" |

| BAG | | PACKING SIZE |
|------------|--------|--------------|
| ARTICLE | MODEL | *W X H X D |
| UYUP070500 | 31.50" | |
| UYUP070600 | 39.37" | |



*W:Width H: Height D: Depth

Super Eco Roll Banners



Pipe fixation and improved end caps provide a more stable to our Super Eco Roll Banner. The new revised design gives a more elegant look to the product. The aluminum body is silver anodized. Stands at 78.75" high. Has a unique collapsable pipe.

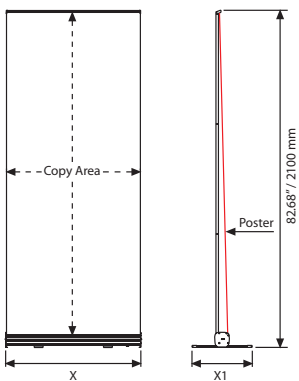

| MATERIAL : Silver anodized aluminum | | | | | | WEIGHT | PACKING SIZE |
|-------------------------------------|-----------------|-----------------|-------------|--------|--------|--------------|------------------------|
| ARTICLE | POSTER | COPY | DESCRIPTION | X | X1 | WITH PACKING | *W X H X D |
| TSZBSE8001 | 31.50" X 78.74" | 31.50" X 77.56" | With bag | 32.01" | 9.25" | 3.880 lbs | 4.53" X 33.86" X 4.53" |
| TSZBSE1001 | 39.37" X 78.74" | 39.37" X 77.56" | With bag | 40.55" | 13.19" | 4.585 lbs | 4.53" X 41.73" X 4.53" |
| TSZBSE6101 | 24.02" X 78.74" | 24.02" X 77.56" | With bag | 24.53" | 9.25" | 3.593 lbs | 4.53" X 25.98" X 4.53" |
| TSZBSE9151 | 36.02" X 78.74" | 36.02" X 77.56" | With bag | 36.54" | 13.19" | 4.144 lbs | 4.53" X 38.39" X 4.53" |
| TSZBSE1221 | 48.03" X 78.74" | 48.03" X 77.56" | With bag | 48.54" | 17.13" | 5.908 lbs | 4.53" X 50.59" X 4.53" |

*W:Width H: Height D: Depth





Printable Solutions

- Maxi Frames
 - River Maxi Frame
 - Bay Maxi Frame
 - Gulf Maxi Frame
 - Lagoon Maxi Frame
 - Ocean Maxi Frame
- Maxi Frame with LED
 - Star Maxi LED
 - Power LED
 - Maxi Frame Totem with LED
 - Semi Products for Maxi Frame
 - Omni Frame
 - Omni A Board



Maxi Frames



It offers a fresh new look to today's display atmosphere which is an alternative to frame systems, Banners, Pop-Ups by applying a printed fabric's installation into the Maxi profile with a sewed or taped nylon strip. The product is a stunning combination of Aluminum and Digital Printing Machines where they unite with a fabric. The attractive point of the product is when it is looked at the front side, you are unable to see the Aluminium Parts of the frame which makes it look frameless.

The details of packaging of the product are:

- All the MAXI FRAMES are individually packed.
- Profiles and connector parts for the required sizes are boxed unassembled.
- Nylon strip is included in each frame.
- Fixing tools are included in each package. Just the feet for Double Sided Ocean Maxi frame must be ordered separately and 4 feet models are available.

Our Maxi Frame Range consists of mainly 5 different profile options. These profiles are designed to make 3 different models of Single Sided MAXI FRAMES, and 2 models of Double Sided MAXI FRAMES. Our standard Maxi Frames are always supplied unassembled providing connectors, hanging parts, and nylon strips. For the double sided ceiling hanger model the hanging wire cable system in each box. Please note, ceiling hanger and 4 feet options should be ordered separately.

Maxi Frame LED Product Programme (Production & Availability)

| Size Available | 25 mm / Star Maxi LED | 50 mm / Star Maxi LED | 34 mm / Maxi Frame |
|------------------|-----------------------|-----------------------|--------------------|
| Poster Size | single | double | single |
| 23 - 20" x 30" | UMLSTN0023 | UMLSCN0023 | UMLD340023 |
| 34 - 30" x 40" | UMLSTN0034 | UMLSCN0034 | UMLD340034 |
| 46 - 40" x 60" | X | X | UMLD340046 |
| Max (w x h) inch | 33.46" x 47.24" | 33.46" x 78.74" | 47.24" x 95.07" |

| Power Consumption | 25 mm / Star Maxi LED | 50 mm / Star Maxi LED | 34 mm / Maxi Frame |
|-------------------|-----------------------|-----------------------|--------------------|
| Poster Size | single | double | single |
| 23 - 20" x 30" | 18,5W / 1,55A | 23W / 1,9A | 31W / 2,6A |
| 34 - 30" x 40" | 26W / 2,1A | 29W / 2,4A | 39,5W / 3,3A |
| 46 - 40" x 60" | X | X | 58W / 4,85A |

| Power Supply Recommended (12 Vdc, Ampere) | 25 mm / Star Maxi LED | 50 mm / Star Maxi LED | 34 mm / Maxi Frame |
|---|-----------------------|-----------------------|--------------------|
| Poster Size | single | double | single |
| 23 - 20" x 30" | 2A | 3A | 4A |
| 34 - 30" x 40" | 3A | 4A | 4A |
| 46 - 40" x 60" | X | X | 6A |

| LUX | 25 mm / Star Maxi LED | 50 mm / Star Maxi LED | 34 mm / Maxi Frame |
|----------------|-----------------------|-----------------------|--------------------|
| Poster Size | single | double | single |
| 23 - 20" x 30" | 1200 - 1500 | 800 - 1200 | 2600 - 3000 |
| 34 - 30" x 40" | 900 - 1000 | 800 - 1000 | 1700 - 2000 |
| 46 - 40" x 60" | X | X | 1400 - 1800 |

- ✓ Standard colour: Silver Anodised
- ✓ Available in RAL colours (subject to MOQ)
- ✓ Power supply is provided with the unit to suit each of the product
- ✓ Luminance: 2000-3000lux (depending on size)
- ✓ Standard Packaging: Single units in polybag and box
- ✓ Low power consumption (see above average power consumption table for each size)
- ✓ Various plugs available such as European, UK, US and Australian
- ✓ Complies with EN55015 & EN61547.

| POWER SUPPLY | |
|--------------|----------------------------|
| ARTICLE | DESCRIPTION |
| UYPLD00010 | Power supply EU 3,34A 7/24 |
| UYPLD00011 | Power supply EU 6,67A 7/24 |
| UYPLD00012 | Power supply EU 8,5A 7/24 |
| UYPLD00013 | Power supply EU 11,5A 7/24 |

- ✓ Products are suitable to use 7/16.
- ✓ If 7/24 use required, please order individually as 7/24 power supplies as below:

 In case of any claim, user is required to return product or any parts to manufacture for analyses at their cost. As long as the manufacturer confirms the problem is a manufacturing fault, the replacement can be provided. This applies for all illuminated products.



Maxi Frames



Single Sided MAXI FRAMES are provided in 3 different profiles in order of thickness:

a) Valet Profile: 15x22 mm profile. The Single Sided MAXI FRAMES made up with Valet Profile are named as RIVER MAXI FRAMES. Available Poster Sizes are: A4, A3, A2, A1, B2, B1, and 50x100cm.

b) Ace Profile: 32x8mm profile. The Single Sided MAXI FRAMES made up with Ace Profile are named as BAY MAXI FRAMES. Available Poster Sizes are: A4, A3, A2, A1, A0, B2, B1, B0, 50x10cm., 100x100cm., 100x150cm., and 100x200cm.

c) Dame Profile: 34x32 mm profile. The Single Sided MAXI FRAMES made up with Dame Profile are named as GULF MAXI FRAMES. Available Poster Sizes are: 100x200cm., 100x300cm., 150x200cm., 150x300cm., 200x200cm., and 200x300cm.

Double Sided MAXI FRAMES are provided in 2 different profiles.

a) Queen Profile: 45x15 mm profile - Suitable for ceiling suspension. The Double Sided MAXI FRAMES made up with Queen Profile are named as LAGOON MAXI FRAMES. Available Poster Sizes are: A4, A3, A2, A1, A0, B2, B1, B0, 50x10cm., 100x100cm., 100x150cm., and 100x200cm.

b) King Profile: 50x40 mm profile - Designed with feet for free standing. The Double Sided MAXI FRAMES made up with King Profile are named as OCEAN MAXI FRAMES. Available Poster Sizes are: 100x140cm., 100x150cm., 100x200cm., 100x225cm., 200x150cm., 200x200cm., 200x225cm., 300x150cm., 300x200cm., and 300x225cm.

We offer MAXI FRAMES both in standard sizes boxed unassembled and also in lengths and parts as semi products.

Find below all the Semi-Products that are used in MAXI FRAMES.

Clear Nylon Strip, Corner Cleat for MAXI FRAMES, Straight Cleat for H-Profile of MAXI FRAME, Square Corner Connector for MAXI FRAME, L-Type Corner Connector for MAXI FRAME, Hanging System including wire cable, Transparent or Gray Color Pull strip.

Find below the names of 4 different feet models: Circle Feet, Hoop Feet, Baseball Feet, and Fillet Feet.



River Maxi Single Sided



Valet Profile / 0.59"x0.87" River Maxi Frame

The single-sided MAXI FRAMES that are made up of Valet Profile are named RIVER MAXI FRAMES.

Hang by using the assembling holes.

The thickness of the channel is 0.16". Supplied nylon strip is 0.12", recommended fabric thickness for digital printing is 0.02". The pull sticker in 0.02" thickness must be sewed on the fabric to take out the poster from channels.

0.51" on each side of the fabric into Maxi Profiles, in total 1.02" on each Fabric Poster is not seen on the poster. Please arrange accordingly. Fabric is not included within the original pack.

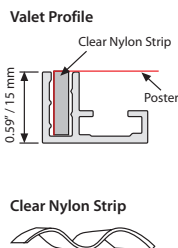
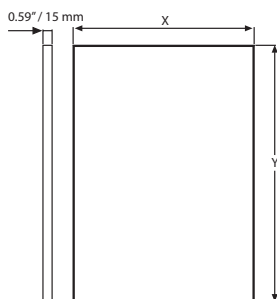

Suggested additional print shares for Maxi Frame's Fabric Posters

| | |
|--------------------------|-------|
| Between 7.87" - 29.53" | 1.10" |
| Between 29.53" - 59.06" | 0.79" |
| Between 59.06" - 118.11" | 0.59" |

e.g. Maxi frame size: 39.37"x11.81"
printed fabric size must be 40.16"x12.91".
But these values might vary according to
the fabric material used.

| MATERIAL : Silver anodised aluminium | | WEIGHT | PACKING SIZE |
|--------------------------------------|----------------|--------------|------------------------|
| ARTICLE | EXTERNAL (x-y) | WITH PACKING | *W X H X D |
| UMFR000017 | 11" X 17" | 1.399 lbs | 2.36" X 18.90" X 1.57" |
| UMFR000018 | 18" X 24" | 1.851 lbs | 2.36" X 25.98" X 1.57" |
| UMFR000022 | 22" X 28" | 2.149 lbs | 2.36" X 30.31" X 1.57" |
| UMFR000024 | 24" X 36" | 2.458 lbs | 2.36" X 37.99" X 1.57" |
| UMFR000074 | 27" X 40" | 2.623 lbs | 2.36" X 41.93" X 1.57" |

* W:Width H: Height D: Depth



Bay Maxi Single Sided

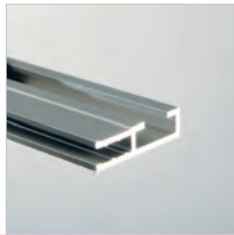

Ace Profile / 1.26"x0.31" Bay Maxi Frame

The single-sided MAXI FRAMES that are made up of Ace Profile are named BAY MAXI FRAMES.

Hang by using the Square Corner Connector pieces. For larger sizes of Bay Maxi Frame, H-Profile is included in the pack with the quantities shown in the table.

The thickness of the channel is 0.16". Supplied nylon strip is 0.12", so recommended fabric thickness for digital printing is 0.02". The pull sticker in 0.02" thickness must be sewed on the fabric for taking out the poster when fitted into the channels.

0.51" on each side of the fabric is fitted into Maxi Profiles, so 1.02" on each Fabric poster is not seen on the poster. Please arrange accordingly. Fabric is not included within the original pack.

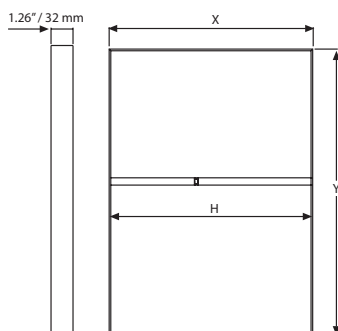

Ace Profile

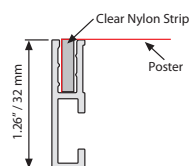

Clear Nylon Strip

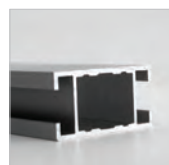

H profile / UYUP014106

| MATERIAL : Silver anodised aluminium | | | | WEIGHT | PACKING SIZE |
|--------------------------------------|----------------|--------|---------|--------------|------------------------|
| ARTICLE | EXTERNAL (x-y) | H (mm) | H (Pcs) | WITH PACKING | *W X H X D |
| UMFB000017 | 11" X 17" | - | - | 1.565 lbs | 2.36" X 18.90" X 1.97" |
| UMFB000018 | 18" X 24" | - | - | 1.807 lbs | 2.36" X 25.98" X 1.97" |
| UMFB000022 | 22" X 28" | - | - | 2.535 lbs | 2.36" X 30.31" X 1.97" |
| UMFB000024 | 24" X 36" | - | - | 2.888 lbs | 2.36" X 37.99" X 1.97" |
| UMFB000036 | 36" X 48" | - | - | 3.858 lbs | 2.36" X 50" X 1.97" |
| UMFB000046 | 40" X 60" | 39.33" | 1 | 6.172 lbs | 2.36" X 61.01" X 1.97" |

*W:Width H: Height D: Depth



Gulf Maxi Single Sided

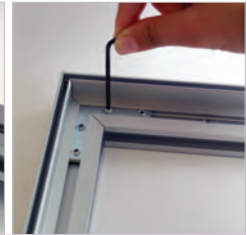
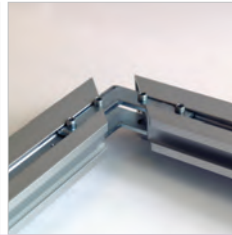
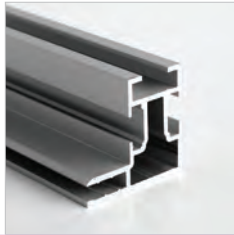

Dame Profile / 1.34"x1.26"

Gulf Maxi Frame

The single-sided MAXI FRAMES that are made up of Dame Profile are named GULF MAXI FRAMES.



Hang by using the assembling holes. The profile edges have corner cleats and are connected by allen key. For larger sizes of Gulf Maxi Frame, H-Profile is included in the pack with the quantities shown in the table.



The thickness of the profile is 0.16". Supplied nylon strip is 0.12", so recommended fabric thickness for digital printing is 0.02". The pull sticker in 0.02" thickness must be sewed on the fabric for taking out the poster when fitted into the channels.



0.51" on each side of the fabric is fitted into Maxi Profiles, so 1.02" on each Fabric Poster is not seen on the poster. Please arrange accordingly. Fabric is not included within the original pack.

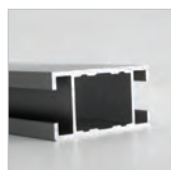
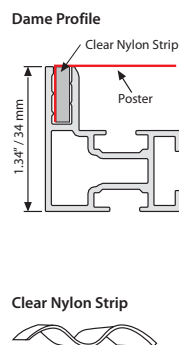
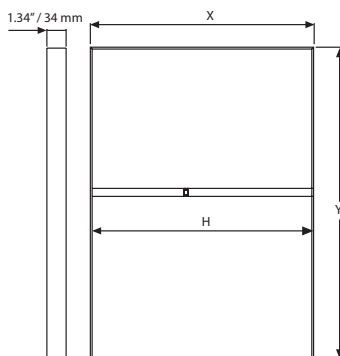
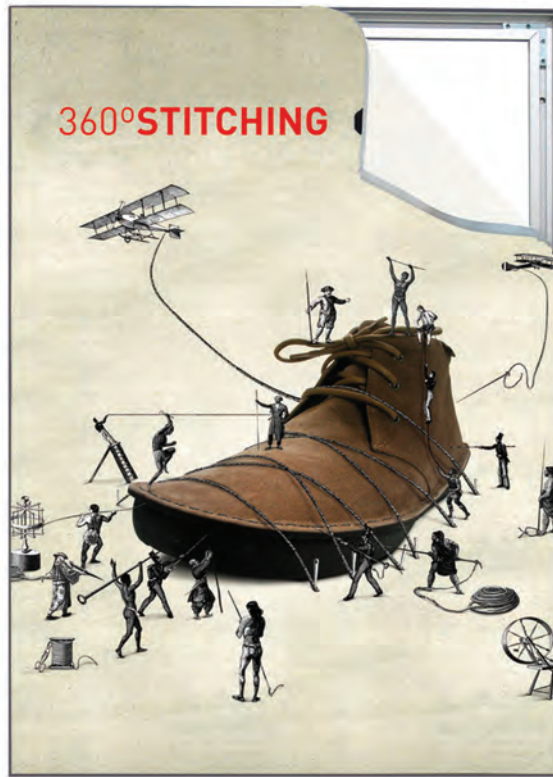

H profile / UYUP014106

| MATERIAL : Silver anodised aluminium | | | | WEIGHT | PACKING SIZE |
|--------------------------------------|----------------|--------|---------|--------------|-------------------------|
| ARTICLE | EXTERNAL (x-y) | H (mm) | H (Pcs) | WITH PACKING | *W X H X D |
| UMFG004060 | 40" X 60" | - | - | 8.267 lbs | 4.33" X 62.01" X 2.36" |
| UMFG004080 | 40" X 80" | - | - | 9.479 lbs | 4.33" X 81.89" X 2.36" |
| UMFG004718 | 47" X 118" | 49.53" | 1 | 17.636 lbs | 4.33" X 120.08" X 2.36" |
| UMFG008018 | 80" X 118" | 77.48" | 1 | 24.691 lbs | 4.33" X 120.08" X 2.36" |

*W:Width H: Height D: Depth



Lagoon Maxi Double Sided



Queen Profile / 1.77"x0.59"

Lagoon Maxi Frame

Used for ceiling hanging. The double-sided MAXI FRAMES that are made up of Queen Profile are named LAGOON MAXI FRAMES.



Suitable to hang from the ceiling. The profiles are connected to each other by the help of Square Corner Connector piece. For larger sizes of Lagoon Maxi Frame, H-Profile must be used. The special hanging pieces for fixing the ceiling with the wire cable, must be fixed into the top short side of the Lagoon Maxi Frame before the profiles are connected to each other.



The thickness of the profile is 0.16". Supplied nylon strip is 0.12", so recommended fabric thickness for digital printing is 0.02". The pull sticker in 0.02" thickness must be sewed on the fabric for taking out the poster when fitted into the channels.



0.51" on each side of the fabric is fitted into Maxi Profiles, so 1.02" on each Fabric Poster is not seen on the poster. Please arrange accordingly. Fabric is not included within the original pack. Ceiling hangers are included in the original pack.



Hanging kit / UYUP460245

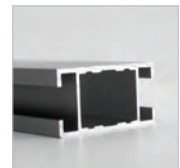

H profile / UYUP014106

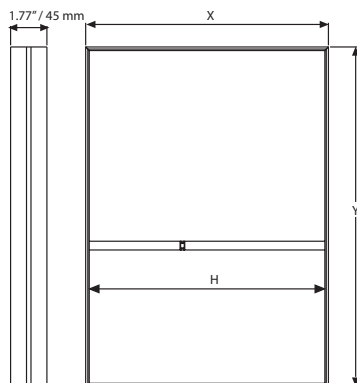

Queen Profile

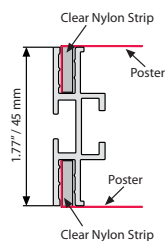

Clear Nylon Strip



| MATERIAL : Silver anodised aluminium | | | | WEIGHT | PACKING SIZE |
|--------------------------------------|----------------|--------|---------|--------------|------------------------|
| ARTICLE | EXTERNAL (x-y) | H (mm) | H (Pcs) | WITH PACKING | *W X H X D |
| UMFL000017 | 11" X 17" | - | - | 2.248 lbs | 3.35" X 18.90" X 2.95" |
| UMFL000018 | 18" X 24" | - | - | 3.284 lbs | 3.35" X 25.98" X 2.95" |
| UMFL000022 | 22" X 28" | - | - | 4.188 lbs | 3.35" X 30.31" X 2.95" |
| UMFL000024 | 24" X 36" | - | - | 4,850 lbs | 3.35" X 37.99" X 2.95" |
| UMFL000036 | 36" X 48" | - | - | 6.062 lbs | 3.35" X 50" X 2.95" |
| UMFL000046 | 40" X 60" | 38.82" | 1 | 8.245 lbs | 3.35" X 62.01" X 2.95" |

*W:Width H: Height D: Depth



Ocean Maxi

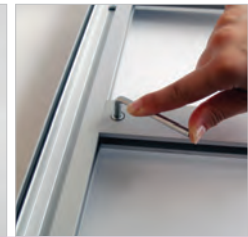
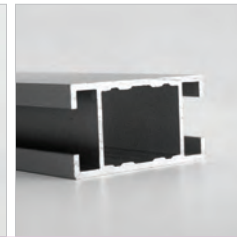
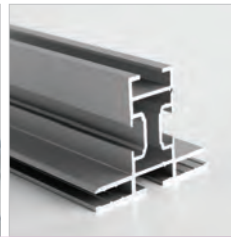

See movie at our website www.mtdisplays.com.tr

King Profile / 1.97"x1.57"

Ocean Maxi Frame

Used with feet to be placed on a floor. The double-sided MAXI FRAMES that are made up of King Profile are named OCEAN MAXI FRAMES. Ocean Frame can be assembled with 4 different feet models. Before the assembly of the profile corners, the connector pieces for the feet need to be fitted into the profiles channels. Then, the feet are assembled over these connector pieces.

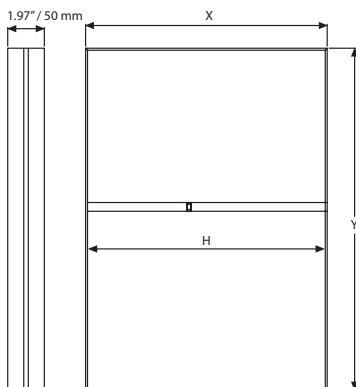

King Profile

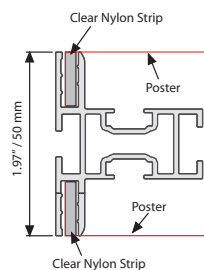

Clear Nylon Strip



| MATERIAL : Silver anodised aluminium | | | | WEIGHT | PACKING SIZE |
|--------------------------------------|----------------|--------|---------|--------------|-------------------------|
| ARTICLE | EXTERNAL (x-y) | H (mm) | H (Pcs) | WITH PACKING | *W X H X D |
| UMFO004060 | 40" X 60" | - | - | 11.816 lbs | 5.51" X 62.01" X 4.33" |
| UMFO006040 | 60" X 40" | - | - | 11.816 lbs | 5.51" X 62.01" X 4.33" |
| UMFO008790 | 87" X 90" | 83.86" | 1 | 21.274 lbs | 5.51" X 92.13" X 4.33" |
| UMFO001090 | 100" X 90" | 86.85" | 1 | 23.038 lbs | 5.51" X 101.97" X 4.33" |
| UMFO001290 | 120" X 90" | 86.85" | 2 | 28.968 lbs | 5.51" X 122.05" X 4.33" |
| UMFO001890 | 118" X 90" | 86.85" | 2 | 28.660 lbs | 5.51" X 120.08" X 4.33" |

*W:Width H: Height D: Depth



Ocean Maxi

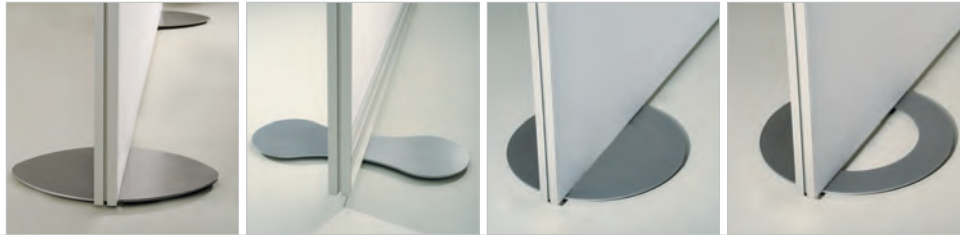

See movie at our website www.mtdisplays.com.tr



It can be used in 2 ways either by hanging to the ceiling or by fitting on 4 different designs of feet. The profiles edges have corner cleats and connected by allen key. For larger sizes of Ocean Maxi Frame, H-Profile must be used for stability. The special hanging pieces for fixing the ceiling with the wire cable, need be fixed into the top short side of the Ocean Maxi Frame before the profiles are connected to each other.



The thickness of the profile is 0.16". Supplied nylon strip is 0.12", so recommended fabric thickness for digital printing is 0.02". The pull sticker in 0.02" thickness must be sewed on the fabric for taking out the poster when fitted into the channels.



0.51" on each side of the fabric is fitted into Maxi Profiles, so as overall 1.02" on each fabric poster is not seen on the poster. Please arrange accordingly. Fabric is not included within the original pack. Feet and ceiling hangers are not included in the original pack, please remember to place a separate order.



Assembly of King Profile / Montage des King Profils



Assembly of H Profile / Montage der Quertraversen



| BASEBALL FEET : RAL 9006 Powder coated, 0.24" steel. | | |
|--|-------------------------|------------|
| ARTICLE | SIZE | WEIGHT |
| UYUP412273 | 17.72" X 11.81" X 0.24" | 10.361 lbs |



| HOOP FEET : RAL 9006 Powder coated, 0.24" steel. | | |
|--|-----------------|-----------|
| ARTICLE | SIZE | WEIGHT |
| UYUP412272 | Ø17.72" X 0.24" | 9.700 lbs |



| CIRCLE FEET : RAL 9006 Powder coated, 0.24" steel. | | |
|--|-----------------|------------|
| ARTICLE | SIZE | WEIGHT |
| UYUP412271 | Ø17.72" X 0.24" | 16.534 lbs |



| FILLET FEET : RAL 9006 Powder coated, 0.24" steel. | | |
|--|------------------------|-----------|
| ARTICLE | SIZE | WEIGHT |
| UYUP412274 | 19.69" X 7.09" X 0.24" | 7.275 lbs |



| FLAT FEET : RAL 9006 Powder coated, 0.20" steel. | |
|--|-------------------------|
| ARTICLE | SIZE |
| UYUP412275 | 15.75" X 19.70" X 0.20" |

Maxi Frame with LED



Dame Profile / 1.34"x1.26"

Maxi Frame with LED

Used with wall mounting fixture on the back. The unit is single sided & edge-lit. Pre-treated light guided panel diffuses light even & powerful. Offers evenly diffused lux in all sizes.



All units pass CE/UL Pat test and packed with quality certificates. 137.80" electrical cable. UK and US plugs should be mentioned on order.



The thickness of the profile is 0.16". Supplied nylon strip is 0.12", so recommended fabric thickness for digital printing is 0.02". The pull sticker in 0.02" thickness must be sewed on the fabric for taking out the poster when fitted into the channels.



0.51" on each side of the fabric is fitted into Maxi Profiles, so 1.02" on each Fabric Poster is not seen on the poster. Please arrange accordingly. Fabric is not included within the original pack.

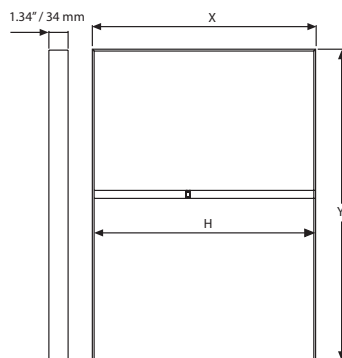

Dame Profile

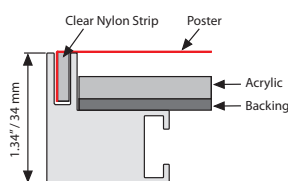

Clear Nylon Strip



| MATERIAL : Silver anodised aluminium | | | | | WEIGHT | PACKING SIZE |
|--------------------------------------|----------------|--------|---------|---------------|--------------|-------------------------|
| ARTICLE | EXTERNAL (x-y) | H (mm) | H (Pcs) | LIGHTING | WITH PACKING | *W X H X D |
| UMLD340018 | 18" X 24" | - | - | 2200-2500 LUX | 11.243 lbs | 18.90" X 25.59" X 1.69" |
| UMLD340022 | 22" X 28" | - | - | 2300-2700 LUX | 14.991 lbs | 22.83" X 29.53" X 1.69" |
| UMLD340023 | 20" X 30" | - | - | 2600-2800 LUX | 14.991 lbs | 20.87" X 31.50" X 1.69" |
| UMLD340024 | 24" X 36" | - | - | 2600-2800 LUX | 19.400 lbs | 34.80" X 37.80" X 1.69" |
| UMLD340034 | 30" X 40" | - | - | 1900-2100 LUX | 23.809 lbs | 31.10" X 41.34" X 1.69" |
| UMLD340036 | 36" X 48" | - | - | 2000-2200 LUX | 33.951 lbs | 36.81" X 49.61" X 1.69" |
| UMLD340046 | 40" X 60" | 37.48" | 1 | 1900-2300 LUX | 45.194 lbs | 40.94" X 61.42" X 1.69" |



*W:Width H: Height D: Depth

Star Maxi LED Single Sided



See movie at our website www.mtdisplays.com.tr



With its very slim profile, 0.94", Star Maxi LED is a modern way of advertising. It is suitable for textile printed graphics. Practical poster application with clear tape provides smooth look. Complete with wall mounting accessories, Star Maxi LED is a practical advertising solution.

All units pass CE/UL Pat test and packed with quality certificates. 11 ft. electrical cable. UK and US plugs should be mentioned on order

The width of the channel is 0.16". Supplied nylon strip is 0.12", so recommended fabric thickness for digital printing is 0.02". The pull sticker in 0.02" thickness must be sewed on the fabric for taking out the poster when fitted into the channels.

0.51" on each side of the fabric is fitted into Maxi Profiles, so 1.02" on each Fabric Poster is not seen on the poster. Please arrange accordingly. Fabric is not included within the original pack.



Portrait

← 0.94" / 24 mm depth

One product, two positions (landscape & portrait)

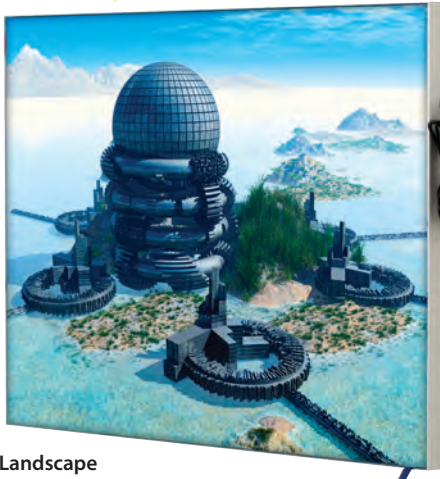

Landscape



2 wall hangers are standard in each product. Moving hangers let the mounting in portrait and landscape position.



Optional dimmer to go with LED illuminated frame.. Simply jack the dimmer in frame and then into powersupply. It adjust the light from dark to max lux of LED illuminated frame.

CE/UL approved.

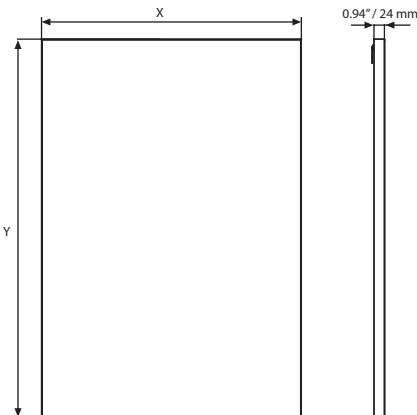

Clear nylon strip
Please don't forget to order.
Including 7/16 power supply.

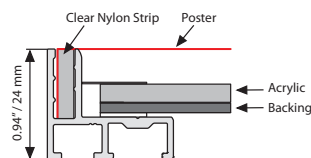

| MATERIAL : Silver anodised aluminium | | | WEIGHT | PACKING SIZE |
|--------------------------------------|----------------|---------------|--------------|-------------------------|
| ARTICLE | EXTERNAL (x-y) | LIGHTING | WITH PACKING | *W X H X D |
| UMLSTN0018 | 18" X 24" | 2500-2700 LUX | 5.952 lbs | 20" X 28.35" X 2.95" |
| UMLSTN0022 | 22" X 28" | 2400-2600 LUX | 8.377 lbs | 23.98" X 32.36" X 2.95" |
| UMLSTN0023 | 20" X 30" | 2300-2600 LUX | 8.157 lbs | 21.97" X 34.33" X 2.95" |
| UMLSTN0024 | 24" X 36" | 2200-2500 LUX | 11.904 lbs | 25.98" X 40.35" X 2.95" |
| UMLSTN0034 | 30" X 40" | 2200-2500 LUX | 21.605 lbs | 37.99" X 44.33" X 2.95" |
| UMLSTN0036 | 36" X 48" | 2100-2400 LUX | 23.368 lbs | 37.99" X 52.36" X 2.95" |
| UMLSTN0046 | 40" X 60" | 2100-2400 LUX | 32.187 lbs | 41.97" X 64.33" X 2.95" |

*W:Width H: Height D: Depth



Star Maxi LED Double Sided



See movie at our website www.mtdisplays.com.tr



With its slim profile, 50mm, double sided Star Maxi LED is a modern way of advertising. It is suitable for textile printed graphics. Practical poster application with clear tape provides smooth look. Complete with ceiling suspension system, Star Maxi LED is a practical advertising solution when message is required to be displayed both ways.



All units pass CE/UL Pat test and packed with quality certificates. 11 ft. electrical cable. UK and US plugs should be mentioned on order



The width of the channel is 0.16". Supplied nylon strip is 0.12", so recommended fabric thickness for digital printing is 0.02". The pull sticker in 0.02" thickness must be sewed on the fabric for taking out the poster when fitted into the channels.



0.51" on each side of the fabric is fitted into Maxi Profiles, so 1.02" on each Fabric Poster is not seen on the poster. Please arrange accordingly. Fabric is not included within the original pack.

One product,
two positions
(landscape&portrait)



Portrait

CE/UL approved.



Landscape

Including suspension kit.

78.74" / 2 meter

1.97" / 50 mm depth



Standard hanging kit for all sizes: 78.74" x 2 pcs wire cable and 2 ceiling hangers.



Optional dimmer to go with LED illuminated frame.. Simply jack the dimmer in frame and then into powersupply. It adjust the light from dark to max lux of LED illuminated frame.

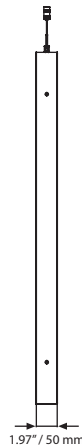
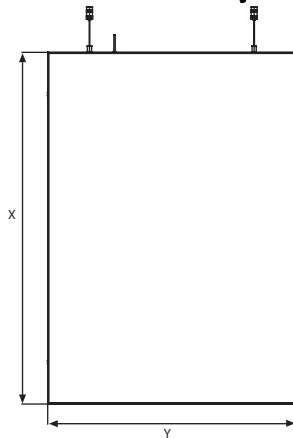

Clear nylon stript
Please don't forget to order.
Including 7/16 power supply.

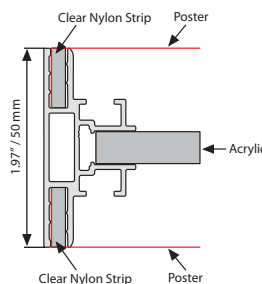

| MATERIAL : Silver anodised aluminium | | | WEIGHT | PACKING SIZE |
|--------------------------------------|----------------|---------------|--------------|-------------------------|
| ARTICLE | EXTERNAL (x-y) | LIGHTING | WITH PACKING | *W X H X D |
| UMLSCN0018 | 18" X 24" | 2700-3300 LUX | 8.598 lbs | 20" X 28.35" X 3.74" |
| UMLSCN0022 | 22" X 28" | 2700-3300 LUX | 12.345 lbs | 23.98" X 32.36" X 3.74" |
| UMLSCN0023 | 20" X 30" | 2700-3200 LUX | 12.345 lbs | 21.97" X 34.33" X 3.74" |
| UMLSCN0024 | 24" X 36" | 2700-3200 LUX | 17.196 lbs | 25.98" X 40.35" X 3.74" |
| UMLSCN0034 | 30" X 40" | 2700-3200 LUX | 28.660 lbs | 37.99" X 44.33" X 3.74" |
| UMLSCN0036 | 36" X 48" | 2700-3300 LUX | 28.660 lbs | 37.99" X 52.36" X 3.74" |
| UMLSCN0046 | 40" X 60" | 2700-3200 LUX | 47.619 lbs | 41.97" X 64.33" X 3.74" |

*W:Width H: Height D:Depth



POWER LED Single Sided



MAXI frame

Available in standard sizes as unassembled and also in lengths and parts as semi products.

For more info contact us!



Parts



Power Maxi Led profiles 39.37"-196.85"

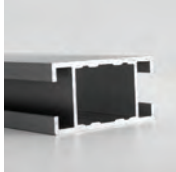

H Profiles



Red & black electrical cable 19.69"-98.43"



Connectors: UYUP412270 Square Corner Connector for Power LED, included in each box.



Power Supplies 90W-160W.



Led Modules 3-S5 LED

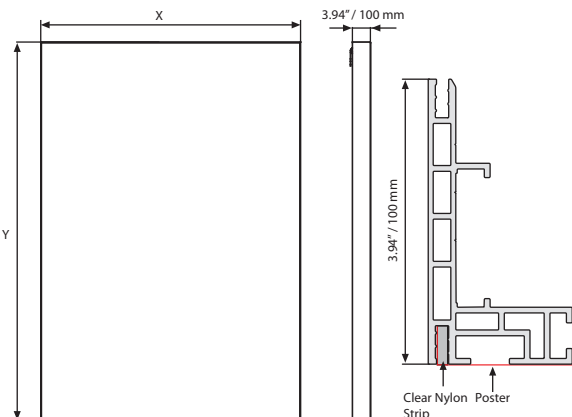
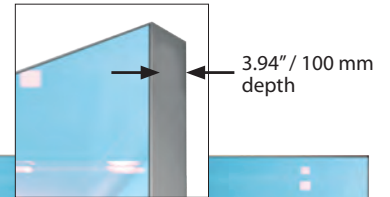

Clear nylon strip.
Please don't forget to order.

MATERIAL : Silver anodised aluminium

| ARTICLE | EXTERNAL (x-y) | LIGHTING |
|------------|----------------|---------------|
| UMPLTN4060 | 40" X 60" | 1900-2300 LUX |
| UMPLTN6040 | 60" X 40" | 1900-2300 LUX |
| UMPLTN8790 | 87" X 90" | 1800-2100 LUX |
| UMPLTN1090 | 100" X 90" | 2000-2300 LUX |
| UMPLTN1290 | 120" X 90" | 2000-2300 LUX |
| UMPLTN1890 | 118" X 90" | 2000-2300 LUX |



CE/UL Patent approved.

Maxi Frame Totem with LED Double Sided



See movie at our website www.mtdisplays.com.tr



Double sided LED Maxi Totem promotes the message with high and even illumination. Pre-treated light guided panel diffuses light even and powerfully. LED illumination saves up to 60% energy costs (compared to fluorescent technology).



All units pass CE/UL PAT tests and are supplied with their quality certificates. Delivered with 8 ft. long cable and EU plug. UK and US plugs should be specified with order.



The thickness of the profile is 0.16". Supplied nylon strip is 0.12", so recommended fabric thickness for digital printing is 0.02". The pull sticker in 0.02" thickness must be sewed on the fabric for taking out the poster when fitted into the channels.



Complete with low voltage 6A powersupply. 0.51" on each side of the fabric is fitted into Maxi Profiles, so 1.02" on each Fabric Poster is not seen on the poster.



2 packs. See info chart for pack sizes.

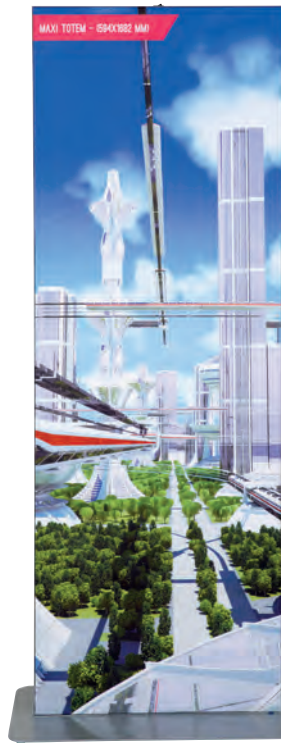

Transparent cable 59.06" / 1500 mm.

CE/UL Patent approved.

1.97" / 50 mm depth

Switch



Sheet metal 0.24" / 6 mm
RAL 9006 powder coated

14.96" / 380 mm
27.56" / 700 mm

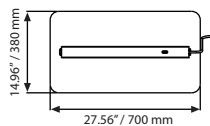
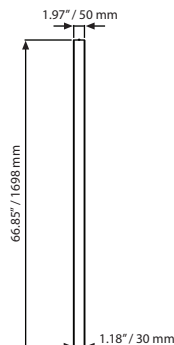
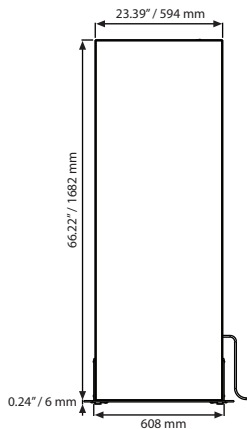

Including 7/16 power supply.



Clear nylon strip
Please don't forget to order.

| MATERIAL : Silver anodised aluminium | | | | | WEIGHT | PACKING SIZE |
|--------------------------------------|----------------|-----------------|-----------------|---------------|-------------------------|---|
| ARTICLE | EXTERNAL (x-y) | POSTER | COPY | LIGHTING | WITH PACKING | *W X H X D |
| UMTLSN02A1 | 23.39" | 23.39" X 66.22" | 23.39" X 66.22" | 2100-2600 LUX | 30,864 lbs / 29,982 lbs | 24.61" X 70.87" X 3.74" / 15.75" X 28.35" X 1.18" |



*W:Width H: Height D: Depth

Semi Products for Maxi Frames



Profiles of Maxi Frames

Valet Profile

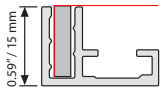

Article: UYUP014103
Single Sided MAXI profile VALET Profile Suitable for RIVER MAXI 0.59"x0.87", 9 ft.

Ace Profile

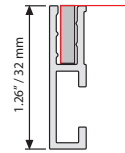

Article: UYUP014105
Single Sided MAXI profile ACE Profile Suitable for BAY MAXI 1.26"x0.31", 9 ft.

Dame Profile

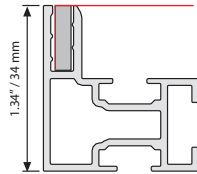

Article: UYUP014102
Single Sided MAXI profile Dame Profile Suitable for GULF MAXI and ILLUMINATED MAXI 1.34"x1.26", 9 ft.

Queen Profile

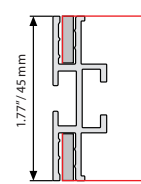

Article: UYUP014104
Double Sided MAXI profile QUEEN Profile Suitable for LAGOON MAXI 1.77"x0.59", 9 ft.

King Profile

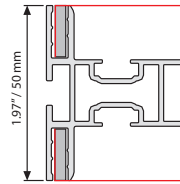

Article: UYUP014101
Double Sided MAXI profile KING Profile Suitable for OCEAN MAXI 1.97"x1.57", 9 ft.

Power LED Profile

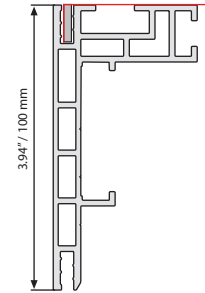

Article: UYPLPT1030
Power LED Profile. 3.94" x 1.99", 9 ft.

Wood Maxi Frame Profile

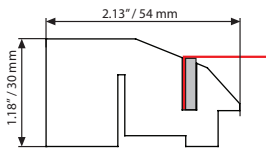

Article: UYPMFWN020
Wood Maxi profile 6 ft. Natural Wood
Article: UYPMFWD020
Wood Maxi profile 6 ft. Dark Wood

Wood Maxi Frame Corner

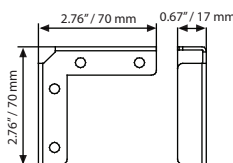

Article: UYPMFW0C00
Wood Maxi Frame corner, 4 Pcs.

H Profile

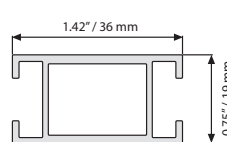

Article: UYUP014106
H Profile, 1.42"x0.75", 9 ft. Suitable for Ace, Dame, Queen and King profiles.

Components of Maxi Frames

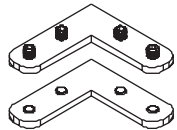

Article: UYUP412295
Corner Cleat for OCEAN & GULF. Packed by 8.



Article: UYUP412270
Square Corner Connector for BAY, LAGOON and Power LED. Packed by 10.

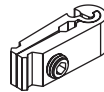

Article: UYUP412291
Straight Cleat for H profile. Packed by 8.

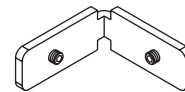

Article: UYUP412310
Straight Cleat for H profile. Packed by 8.



Article: UYUP025010
L TYPE Corner Connector for RIVER. Packed by 10.

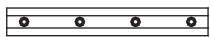

Article: UYUP412320
Flat Connector for Ocean, Gulf, Lagoon and Bay Maxi frame profile. Packed in 10.



Article: UYUP412330
Flat Connector for Gulf Maxi frame profile. Packed in 10.

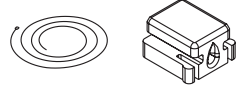

Article: UYUP460245
Hanging System including wire cable for double sided MAXI. Packed by 8.



Article: UYUP460235
Clear Nylon Strip 0.51"x0.12", 328 ft.



Article: UYUP460220
Clear Nylon Strip with tape 0.51"x0.12", 164 ft.

Feets of Maxi Frame (To be used with Double Sided King Profile)

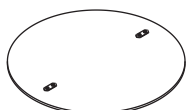

Article: UYUP412271
Circle Ø 17.72" x 0.24" single packed.

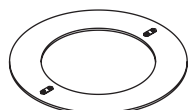

Article: UYUP412272
Hoop Ø 17.72" x 0.24" single packed.

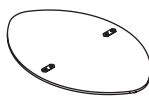

Article: UYUP412273
Baseball 17.72" x 11.81" x 0.24" single packed.



Article: UYUP412274
Fillet 19.69" x 7.09" x 0.24" single packed.

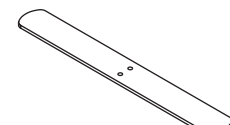

Article: UYUP412275
Flat 15.75" x 19.70" x 0.20" single packed.

Maxi Frames Rubber Strip

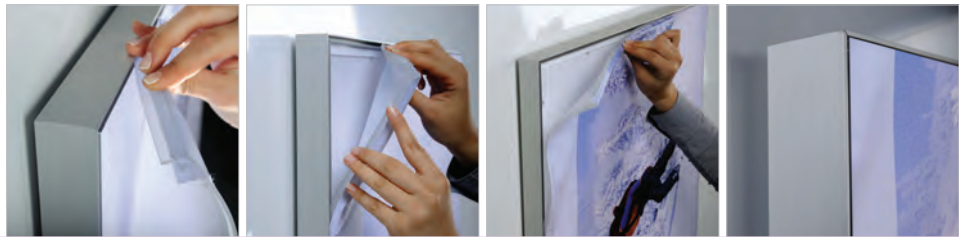

See movie at our website www.mtdisplays.com.tr

Nylon strip application when sew on textile

We launched the new Version 1.0 Maxi Frame rubber strip application existing in Maxi Frame Index. Through this specification development process, we will both assess new opportunities for easy and fast product assembly and the potential to mount Maxi Frames free from sew-on process in exhibitor areas and event places. We invite your participation in following the below information over the increased performance for rubber strips when combined with double sided tape.

Due to the potential expansion of Maxi Frame, which is a high quality frame system composed of stylish aluminum profiles to create a 'frameless' look, in various applications and custom printed

polyester fabric, there have been many requests for easy and sewing-free application of printing inward the profiles.

We redesigned the existing product focusing to purchase, and use of efficient components. For this purpose we concentrated on addition of double sided tape over existing rubber strip.

We defined the types of equipment to cover the new production process of rubber with correct tape and determined the appropriate means of testing the application in tension of various types and thicknesses.

We prepared the below assembly sheet and movie to better express the application and improvement over the taped rubber strip.

NEW Application with double sided tape.



Application of nylon strip by sew-on process



Application of nylon strip by double sided tape



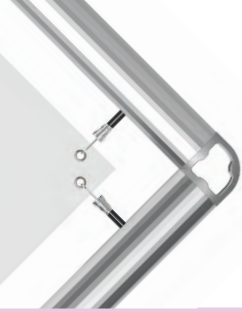

The sky is the limit
with our range of
outdoor banners!

OMNIFRAME

www.omni-frame.com

OHIM DM/084 725

Suitable for outdoor large format prints, Omni Frame is a large format Outdoor Banner System, made from lightweight aluminium. It is ideal for use with PVC eyelet banners. Omni Frame Banner System is used for large advertising areas which need to be changed regularly such as most forecourts and retail environments. It is also a great accompaniment for marquees and race events. Omni Frame is suitable for flat, large banners on buildings as well as mounting stand displays for indoor and outdoor use. The variable lengths of aluminium profile give you the ability to install banners in customised size. This banner holder is assembled quickly and easily, it is a real alternative to traditional billboards. These outdoor durable frames are permanently attached to the wall with the banner using elasticated straps. These are perfect displays for forthcoming events, special offers or sales, theatres, garden centres, retail outlets, sports halls, sporting venues, conferences, airports and public areas. Omni Frame has a smart design and all parts are robust, durable and reusable. The banner is easy to change. Customised sizes are available upon request. It is delivered parts unassembled to save from transport.

FEA TEST RESULTS OF OMNI FRAME

Omni Frame is tested for security in outdoor conditions. Conditions: Without any back rest, Omni Frame is tested against windy conditions max 22,5miles or 36km. Vinyl banner deforms and may not take previous form again based on the type and quality of material.

In case of 2-fold eyelet application, the banner keeps the form upto wind speed of 22miles. Test had been conducted with 196.85" x 393.70" Omni Frame with 0.04" vinyl banner.

Result: Omni Frame is strong and stable for harsh weather conditions. Banner may get damaged depending on the banner and application. MT Displays recommends the apply eyelets 2-fold vinyl banner for harsh weather conditions.



OHIM DM/084 725

Omni Frames



www.omni-frame.com



Fabric is the best recommended option for outdoor advertising. It shines with its light weight and durability among other alternatives such as PVC, Vinyl & Polyethylene. The advantages also include ease of application and compatibility with its stand. The plastic buttons are easily inserted into the channel on Omni Frame profiles. For renewal of the banner, the frame does not have to be unmounted. Poster can only be replaced by taking of the elastic hook.



OHIM DM/084 725

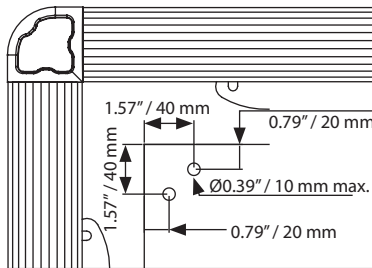
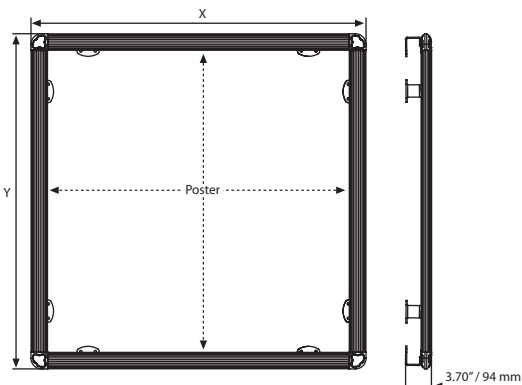

The first eyelet should be placed on the corners 1.57" from the edges of poster used for Omni Frame. Please see below basic drawing. The other eyelets can be applied spacing 5.91"-11.81" from the first eyelet depending on the environment to be used.



Omni Frames



www.omni-frame.com

4 different application options



Omni Frame is a flexible outdoor display system with excellent durability to make combinations via several units for greater visual impact. Limited number of parts, offers solutions for any size request.

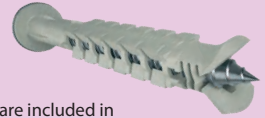

Wall fixing screws of Omni Frame are included in the pack which are CE certified multi-expansion long plugs. Special anti-corrosion coated screw is made of zinc coated steel and plastic sleeve made of high quality of nylon. It is confirmed for outdoor fixing on various exterior building surfaces such as concrete, solid or honeycomb brick, hollow dense or hollow light aggregate block, aerated concrete and solid stone.



UYPOM02000
Corner bracket
(Packed by 4 pcs), Ral 9006



UYPOM03000
T Connector
(Packed by 2 pcs), Ral 9006



UYPOM06000
Profile connector
(Packed by 2 pcs), Ral 9006



UYPOM04000
Wall fixing
(Packed by 4 pcs), including screw set.



UYPOM05000
Plastic buttons
(Packed by 20 pcs)



TMC4010500
Clamp for banner, White
(Packed by 40 pcs)



TSH4010501
Black bungee cord with stainless steel hook
(Packed by 40 pcs)



UYPOM07000
Elastic strap (164 ft)



Aluminium profile, silver anodised.

Presentation Box / UYPOM00010



| OMNI FRAME PROFILE | | WEIGHT | PACKING SIZE |
|--------------------|--------|--------------|------------------------|
| ARTICLE | LENGHT | WITH PACKING | *W X H X D |
| UYPOM00042 | 42" | 2.821 lbs | 9.84" X 11.81" X 2.95" |
| UYPOM00062 | 62" | 3.791 lbs | 9.84" X 11.81" X 3.54" |
| UYPOM00082 | 82" | 4.872 lbs | 9.84" X 11.81" X 3.54" |
| UYPOM00122 | 122" | 7.253 lbs | 9.84" X 11.81" X 3.94" |
| UYPOM00140 | 140" | 8.708 lbs | 9.84" X 11.81" X 3.94" |
| UYPOM00182 | 182" | 11.530 lbs | 9.84" X 11.81" X 4.72" |
| UYPOM00200 | 200" | 12.456 lbs | 9.84" X 11.81" X 5.51" |

| OMNI FRAME: Silver anodised aluminium | | | WEIGHT | PACKING SIZE |
|---------------------------------------|-------------------|-------------|--------------|--------------------------|
| ARTICLE | EXTERNAL (x-y) | POSTER SIZE | WITH PACKING | *W X H X D |
| UOMN001296 | 128.70" X 104.69" | 120" X 96" | 44.312 lbs | 11.81" X 102.36" X 2.76" |
| UOMN001284 | 128.70" X 92.70" | 120" X 84" | 42.549 lbs | 11.81" X 90.55" X 2.76" |
| UOMN009684 | 104.69" X 92.70" | 96" X 84" | 37.699 lbs | 7.87" X 102.36" X 2.76" |
| UOMN001212 | 128.70" X 128.70" | 120" X 120" | 49.383 lbs | 7.87" X 63.78" X 5.51" |



Insert and fix with screw.



Corner bracket made of aluminium injection metallic silver powder coated.



Insert banner buttons into the rear channel of the profile.

| OMNI FRAME SEMI PRODUCTS | | WEIGHT | PACKING SIZE |
|--------------------------|--|--------------|------------------------|
| ARTICLE | DESCRIPTION | WITH PACKING | *W X H X D |
| UYPOM02000 | Corner Bracket (Packed by 4 pcs), Ral 9006 | 3.968 lbs | 3.74" X 9.45" X 6.50" |
| UYPOM03000 | T Connector (Packed by 2 pcs), Ral 9006 | 1.984 lbs | 3.74" X 9.45" X 6.50" |
| UYPOM04000 | Wall Fixing (Packed by 4 pcs), including screw set | 4.409 lbs | 3.74" X 5.91" X 3.94" |
| UYPOM05000 | Plastic Buttons (Packed by 20 pcs) | 0.044 lbs | |
| UYPOM06000 | Profile Connector (Packed by 2 pcs), Ral 9006 | 0.881 lbs | 3.35" X 10.63" X 3.54" |
| TMC4010500 | Clamp For Banner, White (Packed by 40 pcs) | 1.146 lbs | |
| TSH4010501 | Black Bungee Cord with Stainless Steel Hook (Packed by 40 pcs) | 0.925 lbs | |
| UYPOM07000 | Elastic Strap (164 ft) | 0.220 lbs | |

*W:Width H: Height D: Depth



Omni A Boards



www.omni-frame.com



Constructed aluminium, Omni A Board is a double sided, heavy outdoor banner system. It is ideal for use with PVC eyelet banners. Omni A Board is used for large advertising areas that the banner needs to be changed regularly or carried to different places. It is a great accompaniment for outdoor events, marquees and race. Omni Frame withstands approximately 42-50kph wind.

-  Shipped unassembled.
-  Banner and eyelets not included.
-  Plastic buttons and elastic hooks included enough for each size.
-  2 packs. See info chart for pack sizes.

Perfect outdoor use.

- Ease of transport, quick&easy installation.
- Flexible outdoor display with excellent durability.



OHIM DM/084 725



Carry bag

| BAG: Black | |
|------------|--------------------------|
| ARTICLE | SIZE |
| UYPOM00010 | 10.43" X 104.33" X 8.07" |
| UYPOM00020 | 10.43" X 64.17" X 8.07" |

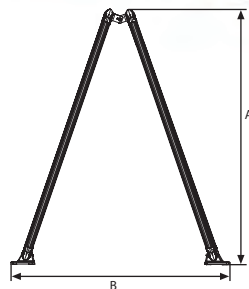
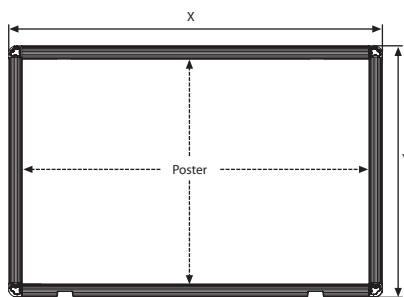

2.645 lbs. Each feet.
Feet optional accessories.

| OMNI A BOARD FEET / HINGE | |
|---------------------------|--------------------------------------|
| ARTICLE | DESCRIPTION |
| UYPOM09000 | Feet for Omni Aboard, 4pcs per pack |
| UYPOM10000 | Hinge for Omni Aboard, 2pcs per pack |

| OMNI FRAME: Silver anodised aluminium | | | | WEIGHT | | PACKING SIZE | |
|---------------------------------------|------------------|-------------|---------|--------|--------------|--|--|
| ARTICLE | EXTERNAL (x-y) | POSTER SIZE | A | B | WITH PACKING | *W X H X D | |
| UAOMN04059 | 48.70" X 67.70" | 40" X 59" | 65.35" | 48.82" | 43.210 lbs | 10.43" X 64.57" X 3.54" / 13.39" X 19.29" X 5.31" | |
| UAOMN04098 | 48.70" X 106.70" | 40" X 98" | 94.49" | 64.57" | 52.910 lbs | 10.83" X 104.33" X 3.54" / 13.39" X 19.29" X 5.31" | |
| UAOMN04918 | 49.83" X 126.70" | 49" X 118" | 113.98" | 70.87" | 62.390 lbs | 10.83" X 62.99" X 5.71" / 13.39" X 19.69" X 7.68" | |



*W:Width H: Height D: Depth



Sign Holders

- Poster Stands
- Oval Based Floor Poster Stands
- Eco Floor Poster Stands
- Novel Display Stands **NEW**
- Display Stands
- Display Stand Banner Sets
- Display Stand Slide-in Frames
- Poster Display Convex Boxes
- Totems
- Decorative Totems
- Mono Totems
- LEDA Illuminated Magnetic Totems





Poster Stand



Single Sided / Double Sided
Single faced acrylic shelves and wheels can be added to the info boards. An anti-reflex PET cover is presented in each unit. 1.25" profile snap frame is used.

 The product is packed unassembled with an easy to understand instruction sheet & fixing hardware.

 Wheels can be ordered optionally.

 Acrylic shelves should be ordered separately.

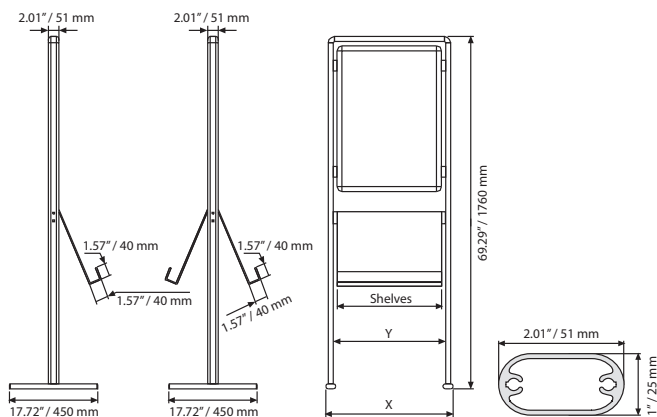

| SINGLE SIDED : Silver anodized aluminum | | | | WEIGHT | PACKING SIZE | Shelves : 4 mm acrylic | |
|---|-----------|--------|--------|--------------|-------------------------|------------------------|------------------|
| ARTICLE | POSTER | X | Y | WITH PACKING | *W X H X D | SINGLE SIDED | MAX. CAPACITY |
| UIB200TN18 | 18" X 24" | 24.33" | 27.32" | 17.636 lbs | 24.41" X 68.90" X 2.56" | UYRTO002A4 | 2 X (8.5" X 11") |
| UIB200TN22 | 22" X 28" | 28.35" | 31.34" | 20.943 lbs | 28.35" X 69.29" X 2.36" | UYRTO003A4 | 3 X (8.5" X 11") |
| DOUBLE SIDED : Silver anodized aluminum | | | | WEIGHT | PACKING SIZE | Shelves : 4 mm acrylic | |
| ARTICLE | POSTER | X | Y | WITH PACKING | *W X H X D | DOUBLE SIDED | MAX. CAPACITY |
| UIB200CN18 | 18" X 24" | 24.33" | 27.32" | 20.943 lbs | 24.41" X 68.90" X 2.56" | UYRC0002A4 | 4 X (8.5" X 11") |
| UIB200CN22 | 22" X 28" | 28.35" | 31.34" | 22.928 lbs | 28.35" X 69.29" X 2.36" | UYRC0003A4 | 6 X (8.5" X 11") |

*W:Width H: Height D: Depth



Oval Based Floor Poster Stand



Oval Info board is a double-sided economy floor stand. The black PVC in the middle of 2 posters prevents light transmission.

The product is packed unassembled with an easy to understand instruction sheet & fixing hardware.

Delivered with poster protective set that includes 2 clear + 1 black sheet.

Heavy base provides stability.

2 packs. See info chart for pack sizes.

Color options



Silver Black

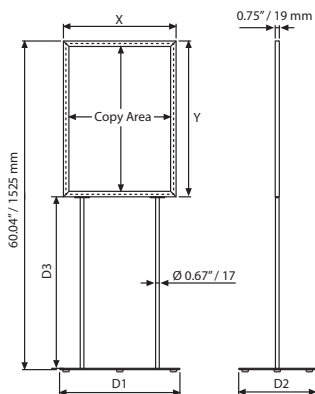
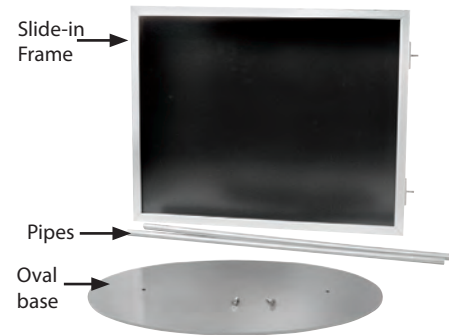
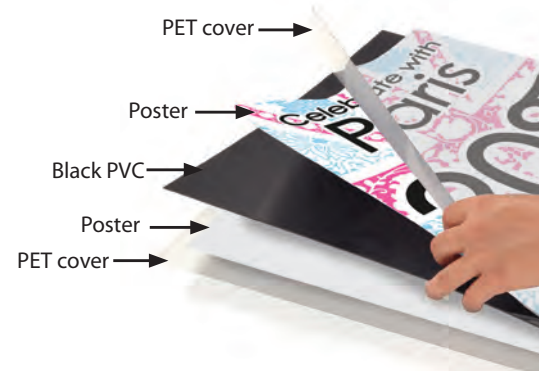

| MATERIAL : Silver & black anodized aluminum | | | | | | | WEIGHT | PACKING SIZE | |
|---|--------|-----------------|-----------|-----------------|--------|--------|--------|--------------|---|
| ARTICLE | COLOUR | EXTERNAL (x-y) | POSTER | COPY | D1 | D2 | D3 | WITH PACKING | *W X H X D |
| UIBS10N022 | Silver | 22.91" X 28.91" | 22" X 28" | 20.90" X 26.90" | 22.05" | 14.09" | 30.71" | 28.108 lbs | 23.62" X 29.53" X 0.79" / 14.96" X 22.64" X 1.18" |
| UIBS10N024 | Silver | 24.91" X 36.91" | 24" X 36" | 22.90" X 34.90" | 22.05" | 14.09" | 25.59" | 29.762 lbs | 25.20" X 37.01" X 0.79" / 14.96" X 22.64" X 1.18" |
| UIBS10B022 | Black | 22.91" X 28.91" | 22" X 28" | 20.90" X 26.90" | 22.05" | 14.09" | 30.71" | 28.086 lbs | 23.62" X 29.53" X 0.79" / 14.96" X 22.64" X 1.18" |
| UIBS10B024 | Black | 24.91" X 36.91" | 24" X 36" | 22.90" X 34.90" | 22.05" | 14.09" | 25.59" | 29.762 lbs | 25.20" X 37.01" X 0.79" / 14.96" X 22.64" X 1.18" |

*W:Width H: Height D: Depth



Eco Floor Poster Stands



See movie at our website www.mtdisplays.com.tr

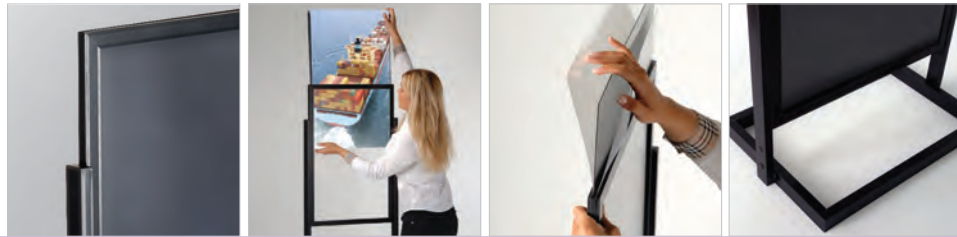

Eco Info board is a new double-sided economy floor stand. The black PVC in the middle of 2 posters prevents light transmission. Easy to change poster by simply sliding it in through the channels of the stand. Eco Info board has different models that can go up to 2 or 3 tier and display max. 6 posters at once. It is suitable for public spaces. The square base provides stability.

The product is packed unassembled with an easy to understand instruction sheet & fixing hardware.

Delivered with poster protective set that includes 2 clear + 1 black sheet.

Color options



Silver Black



1 Tier - Black



2 Tier - Silver



19.69" X 66.93" (500 X 1700 mm)

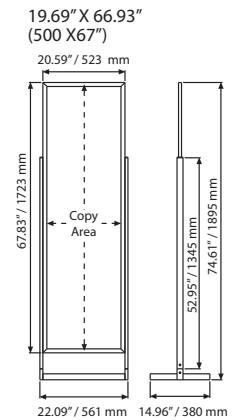

| MATERIAL : Silver & black aluminum | | | | WEIGHT | PACKING SIZE |
|------------------------------------|-----------|-----------------|---------------------|--------------|-------------------------|
| ARTICLE | POSTER | COPY | MODEL | WITH PACKING | *W X H X D |
| UIBS20N129 | 22" X 69" | 20.91" X 67.91" | Silver anodized | 24.691 lbs | 26.38" X 80.12" X 3.35" |
| UIBS20C129 | 22" X 69" | 20.91" X 67.91" | Black powder coated | 24.691 lbs | 26.38" X 80.12" X 3.35" |

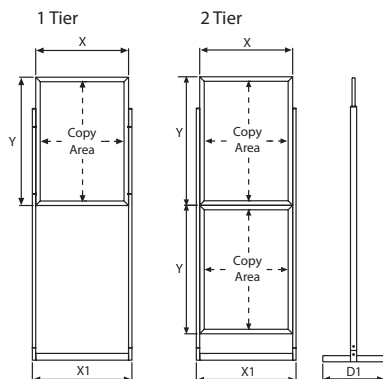

| MATERIAL : Silver & black aluminum | | | | | | | | WEIGHT | PACKING SIZE |
|------------------------------------|-----------------|-----------|-----------------|--------|--------|--------|--------|--------------|-------------------------|
| ARTICLE | DESCRIPTION | POSTER | COPY | X | X1 | Y | D1 | WITH PACKING | *W X H X D |
| UIBS20N118 | 1 Tier - Silver | 18" X 24" | 16.93" X 22.91" | 18.94" | 20.47" | 24.92" | 14.96" | 14.175 lbs | 23.43" X 69.29" X 3.35" |
| UIBS20N122 | 1 Tier - Silver | 22" X 28" | 20.91" X 26.93" | 22.91" | 24.45" | 28.94" | 14.96" | 16.203 lbs | 27.36" X 65.75" X 3.35" |
| UIBS20N124 | 1 Tier - Silver | 24" X 36" | 22.91" X 34.92" | 24.92" | 26.46" | 36.93" | 14.96" | 16.975 lbs | 29.53" X 69.29" X 3.35" |
| UIBS20B118 | 1 Tier - Black | 18" X 24" | 16.93" X 22.91" | 18.94" | 20.47" | 24.92" | 14.96" | 14.219 lbs | 23.43" X 69.29" X 3.35" |
| UIBS20B122 | 1 Tier - Black | 22" X 28" | 20.91" X 26.93" | 22.91" | 24.45" | 28.94" | 14.96" | 16.203 lbs | 27.36" X 65.75" X 3.35" |
| UIBS20B124 | 1 Tier - Black | 24" X 36" | 22.91" X 34.92" | 24.92" | 26.46" | 36.93" | 14.96" | 16.975 lbs | 29.53" X 69.29" X 3.35" |
| UIBS20N218 | 2 Tier - Silver | 18" X 24" | 16.93" X 22.91" | 18.94" | 20.47" | 24.92" | 17.72" | 18.210 lbs | 23.43" X 73.43" X 3.35" |
| UIBS20N222 | 2 Tier - Silver | 22" X 28" | 20.91" X 26.93" | 22.91" | 24.45" | 28.94" | 17.72" | 21.715 lbs | 27.36" X 65.75" X 3.35" |
| UIBS20N224 | 2 Tier - Silver | 24" X 36" | 22.91" X 34.92" | 24.92" | 26.46" | 36.93" | 17.72" | 23.589 lbs | 27.17" X 76.57" X 3.35" |
| UIBS20B218 | 2 Tier - Black | 18" X 24" | 16.93" X 22.91" | 18.94" | 20.47" | 24.92" | 17.72" | 18.210 lbs | 23.43" X 73.43" X 3.35" |
| UIBS20B222 | 2 Tier - Black | 22" X 28" | 20.91" X 26.93" | 22.91" | 24.45" | 28.94" | 17.72" | 21.715 lbs | 27.36" X 65.75" X 3.35" |
| UIBS20B224 | 2 Tier - Black | 24" X 36" | 22.91" X 34.92" | 24.92" | 26.46" | 36.93" | 17.72" | 23.589 lbs | 27.17" X 76.57" X 3.35" |

*W:Width H:Height D:Depth



Novel Display Stand



See movie at our website www.mtdisplays.com.tr



New to our range, this robust, silver anodised Novel Free Standing brochure and sign system allows designing various styles to suit different environment. 4-channel profile holds accessories to make single sided or double sided display system.

- Product is packed unassembled with an easy-to understand instruction sheet & fixing set.
- Make up your own stand in your desired variation. Heavy & stable base for public spaces.
- Please order the accessories separately.
- 2 packs. See info chart for pack sizes.
- Assembled in 40 seconds

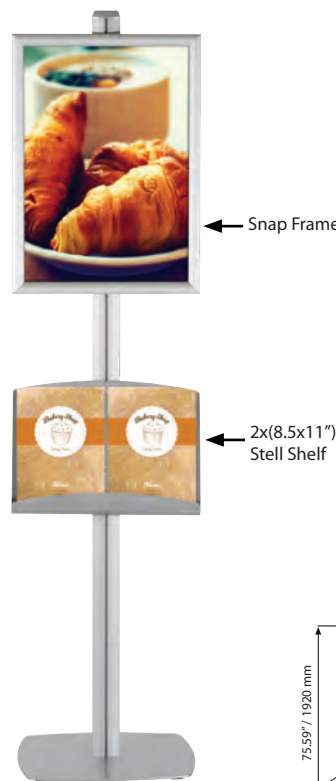
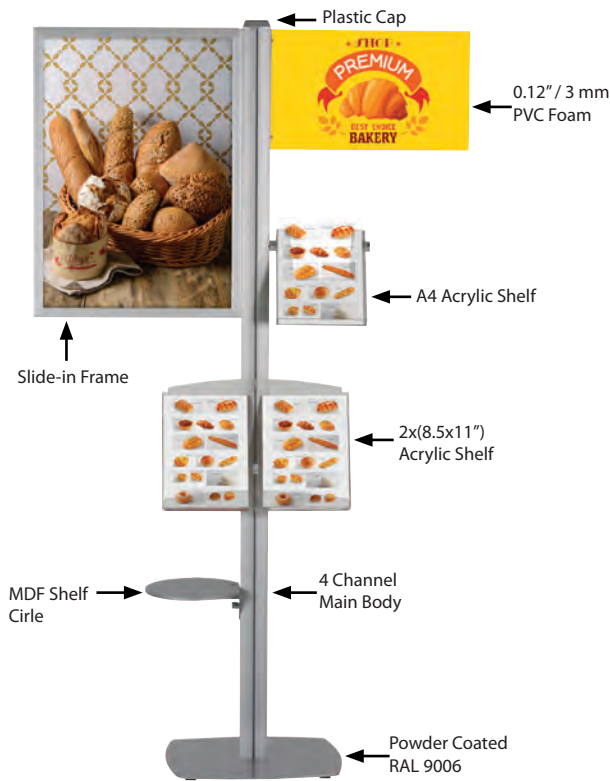

Some possible variations using 4 channel profile

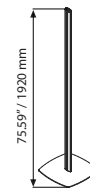
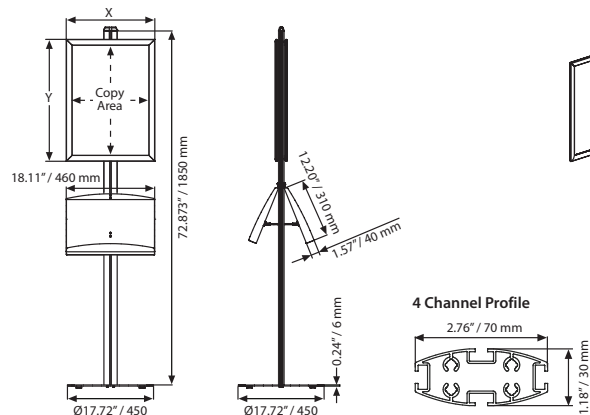
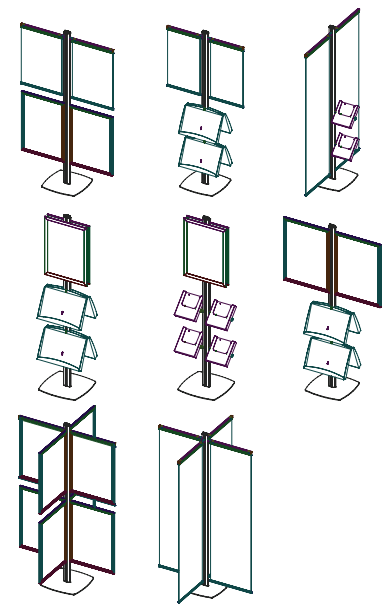

| MAINBODY WITH 4 CHANNEL: Powder coated in RAL 9006 | | | |
|--|----------------|--------------|--------------------------|
| | | WEIGHT | PACKING SIZE |
| ARTICLE | DESCRIPTION | WITH PACKING | *W X H X D |
| UFSL001200 | Main body pole | 5.291 lbs | 3.35\" X 75.4\" X 1.77\" |
| | Main body base | 22.046 lbs | 18.5\" X 18.5\" X 1.77\" |

| SNAP FRAME: 1\"/> | | | | | | | |
|-------------------|------------|-------------|-------------------|--------------|-------------------|---------------------|----------------------------|
| MITRED | ROUND | DESCRIPTION | EXTERNAL (x-y) | POSTER | COPY | WEIGHT WITH PACKING | PACKING SIZE *W X H X D |
| UFSL000081 | UFSL010081 | Silver | 9.69\" X 12.17\" | 8.5\" X 11\" | 7.80\" X 10.28\" | 1.102 lbs | 10.63\" X 12.20\" X 0.83\" |
| UFSL000017 | UFSL010017 | Silver | 12.17\" X 18.19\" | 11\" X 17\" | 10.28\" X 16.30\" | 1.873 lbs | 12.99\" X 18.90\" X 0.83\" |
| UFSL000014 | UFSL010014 | Silver | 15.20\" X 23.19\" | 14\" X 22\" | 13.31\" X 21.30\" | 2.711 lbs | 16.54\" X 24.41\" X 0.83\" |
| UFSL000018 | UFSL010018 | Silver | 19.21\" X 25.50\" | 18\" X 24\" | 17.32\" X 23.31\" | 2.645 lbs | 20.08\" X 25.98\" X 0.83\" |
| UFSL000022 | UFSL010022 | Silver | 23.19\" X 29.17\" | 22\" X 28\" | 21.30\" X 27.28\" | 3.637 lbs | 24.02\" X 30.31\" X 0.83\" |
| UFSLB00081 | UFSL01B081 | Black | 9.69\" X 12.17\" | 8.5\" X 11\" | 7.80\" X 10.28\" | 1.102 lbs | 10.63\" X 12.20\" X 0.83\" |
| UFSLB00017 | UFSL01B017 | Black | 12.17\" X 18.19\" | 11\" X 17\" | 10.28\" X 16.30\" | 1.873 lbs | 12.99\" X 18.90\" X 0.83\" |
| UFSLB00014 | UFSL01B014 | Black | 15.20\" X 23.19\" | 14\" X 22\" | 13.31\" X 21.30\" | 2.711 lbs | 16.54\" X 24.41\" X 0.83\" |
| UFSLB00018 | UFSL01B018 | Black | 19.21\" X 25.50\" | 18\" X 24\" | 17.32\" X 23.31\" | 2.645 lbs | 20.08\" X 25.98\" X 0.83\" |
| UFSLB00022 | UFSL01B022 | Black | 23.19\" X 29.17\" | 22\" X 28\" | 21.30\" X 27.28\" | 3.637 lbs | 24.02\" X 30.31\" X 0.83\" |





*W:Width H: Height D: Depth

Display Stand



2 Channel

An ideal brochure stand that permits an indoor use of different models. The fixing grooves on both sides of the central pole hold single-sided or double-sided frames and shelves separately or collectively at the same time. The frames are recommended for use in 1.1" profiles in both portrait or landscape position. The powder coated steel shelves are 0.05" thick, and the clear acrylic shelves are 0.16" thick.

-  The product is packed unassembled with an easy to understand instruction sheet & fixing hardware.
-  Make up your own stand in your desired variation. Heavy & stable base for public spaces.
-  2 packs. See info chart for pack sizes.



Some possible variation.

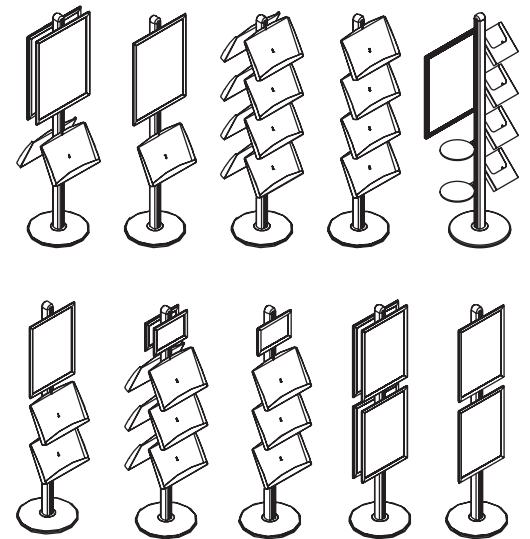

75.59" / 1920 mm

| MAINBODY WITH 2 CHANNEL: Powder coated in RAL 9006 | | | |
|--|----------------|--------------|-------------------------|
| | | WEIGHT | PACKING SIZE |
| ARTICLE | DESCRIPTION | WITH PACKING | *W X H X D |
| UFSL001000 | Main body pole | 7.605 lbs | 3.15" X 76.7" X 3.15" |
| | Main body base | 19.731 lbs | 19.29" X 19.29" X 1.97" |

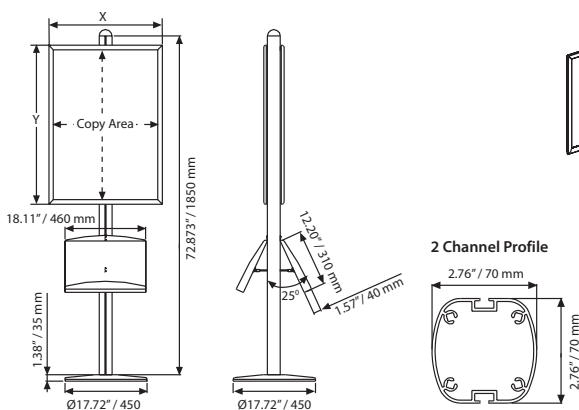

| SNAP FRAME: 1" / 45° - Round | | | | | | WEIGHT | PACKING SIZE |
|------------------------------|------------|-------------|-----------------|------------|-----------------|--------------|-------------------------|
| MITRED | ROUND | DESCRIPTION | EXTERNAL (x-y) | POSTER | COPY | WITH PACKING | *W X H X D |
| UFSL000081 | UFSL010081 | Silver | 9.69" X 12.17" | 8.5" X 11" | 7.80" X 10.28" | 1.102 lbs | 10.63" X 12.20" X 0.83" |
| UFSL000017 | UFSL010017 | Silver | 12.17" X 18.19" | 11" X 17" | 10.28" X 16.30" | 1.873 lbs | 12.99" X 18.90" X 0.83" |
| UFSL000014 | UFSL010014 | Silver | 15.20" X 23.19" | 14" X 22" | 13.31" X 21.30" | 2.711 lbs | 16.54" X 24.41" X 0.83" |
| UFSL000018 | UFSL010018 | Silver | 19.21" X 25.50" | 18" X 24" | 17.32" X 23.31" | 2.645 lbs | 20.08" X 25.98" X 0.83" |
| UFSL000022 | UFSL010022 | Silver | 23.19" X 29.17" | 22" X 28" | 21.30" X 27.28" | 3.637 lbs | 24.02" X 30.31" X 0.83" |
| UFSLB00081 | UFSL01B081 | Black | 9.69" X 12.17" | 8.5" X 11" | 7.80" X 10.28" | 1.102 lbs | 10.63" X 12.20" X 0.83" |
| UFSLB00017 | UFSL01B017 | Black | 12.17" X 18.19" | 11" X 17" | 10.28" X 16.30" | 1.873 lbs | 12.99" X 18.90" X 0.83" |
| UFSLB00014 | UFSL01B014 | Black | 15.20" X 23.19" | 14" X 22" | 13.31" X 21.30" | 2.711 lbs | 16.54" X 24.41" X 0.83" |
| UFSLB00018 | UFSL01B018 | Black | 19.21" X 25.50" | 18" X 24" | 17.32" X 23.31" | 2.645 lbs | 20.08" X 25.98" X 0.83" |
| UFSLB00022 | UFSL01B022 | Black | 23.19" X 29.17" | 22" X 28" | 21.30" X 27.28" | 3.637 lbs | 24.02" X 30.31" X 0.83" |



*W:Width H: Height D: Depth

Display Stands



4 Channel

An ideal brochure stand for indoor use with different options. The fixing grooves on four sides of the central pole hold single-sided or double-sided frames and shelves separately or collectively at the same time. The frames are recommended in 1.1" profiles to be used in both portrait or landscape positions. The powder coated steel shelves are 0.05" thick and the clear acrylic shelves are 0.16". Each Shelves has a 2 x 8.5" X 11" capacity. Silver anodized and Black colors available.

Product is packed unassembled with an easy to understand instruction sheet & fixing set.

Make up your own stand in your desired variation. Heavy & stable base for public spaces.

2 packs. See info chart for pack sizes.



Some possible variation.

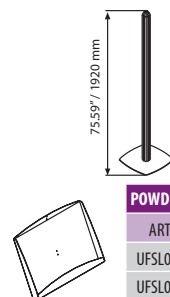
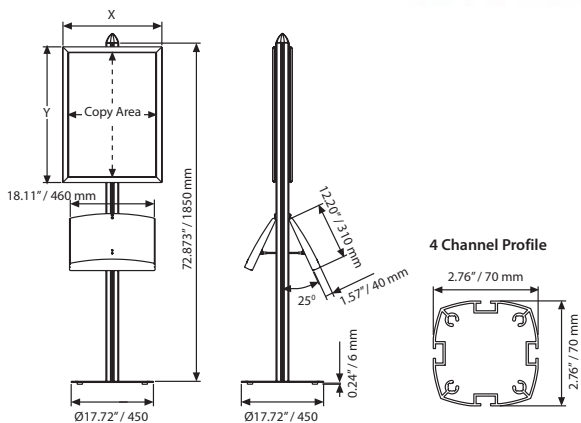
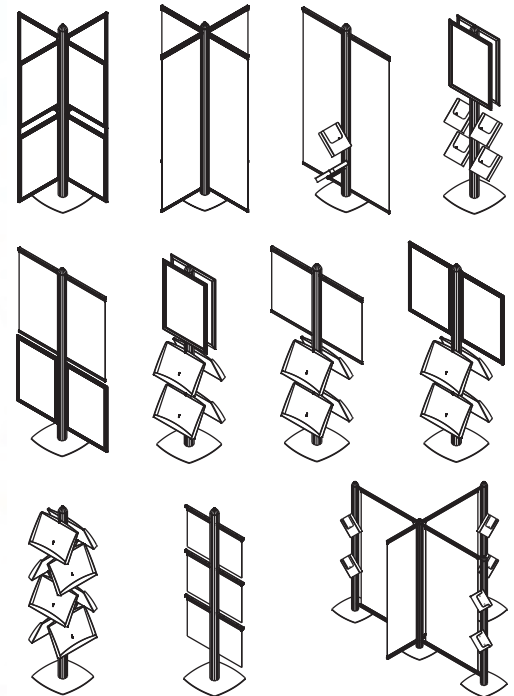

| MAINBODY WITH 4 CHANNEL: Powder coated in RAL 9006 | | | |
|--|----------------|---------------------|-------------------------|
| ARTICLE | DESCRIPTION | WEIGHT WITH PACKING | PACKING SIZE *W X H X D |
| UFSL001100 | Main body pole | 7.605 lbs | 3.15" X 76.7" X 3.15" |
| | Main body base | 19.731 lbs | 19.29" X 19.29" X 1.97" |

| POWDER COATED STEEL&ACRYLIC Shelves | | | |
|-------------------------------------|--------------------------------|---------------------|-------------------------|
| ARTICLE | CAPACITY | WEIGHT WITH PACKING | PACKING SIZE *W X H X D |
| UFSL002000 | 2 X 8.5" X 11" steel Shelves | 3.968 lbs | 14.17" X 18.50" X 2.36" |
| UFSL003000 | 2 X 8.5" X 11" acrylic Shelves | 3.086 lbs | 14.17" X 18.50" X 2.36" |

* W:Width H: Height D: Depth



Display Stand Shelves



An ideal brochure stand that allows for various different models for indoor use. Grey and Black color available.



Shelves options: 1. model

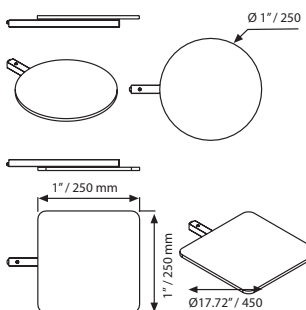

Shelves options: 2. model

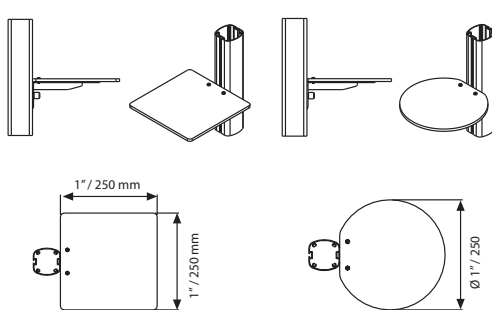

| Shelves OPTIONS 1: 0.31" MDF | | | WEIGHT | PACKING SIZE |
|------------------------------|--------|-----------------|--------------|-------------------------|
| ARTICLE | MODEL | WEIGHT CAPACITY | WITH PACKING | *W X H X D |
| UFSL002500 | Circle | max. 2.204 lbs | 1.344 lbs | 10.24" X 13.78" X 1.38" |
| UFSL002510 | Square | max. 2.204 lbs | 1.554 lbs | 10.24" X 13.78" X 1.38" |
| Shelves OPTIONS 2: 0.31" MDF | | | WEIGHT | PACKING SIZE |
| ARTICLE | MODEL | WEIGHT CAPACITY | WITH PACKING | *W X H X D |
| UFSL002550 | Circle | max. 11.023 lbs | 1.829 lbs | 10.63" X 11.22" X 4.13" |
| UFSL002560 | Square | max. 11.023 lbs | 2.226 lbs | 10.63" X 11.22" X 4.13" |



*W:Width H: Height D: Depth

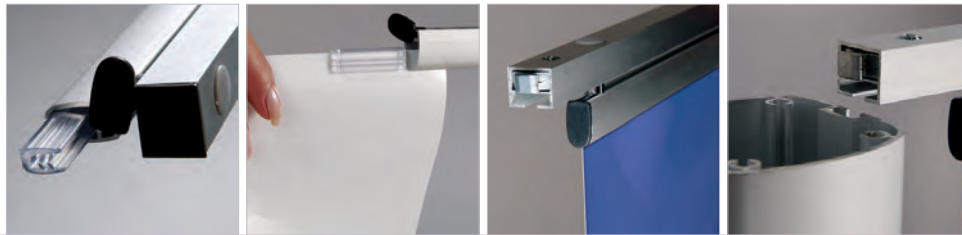

Display Stand Banner Sets



An ideal brochure stand that enables indoor use of different models. Silver anodized and Black colors available.

-  Product is packed unassembled with an easy to understand instruction sheet & fixing hardware.
-  Make up your own stand in your desired variation. Heavy & stable base for public spaces.
-  Banner width is recommended minimum 15.7". max 27.5". Banner height is adjustable up to 66.93".

Novel Free Standing 4 channel model



Free Standing 4 channel model



Free Standing 2 channel model

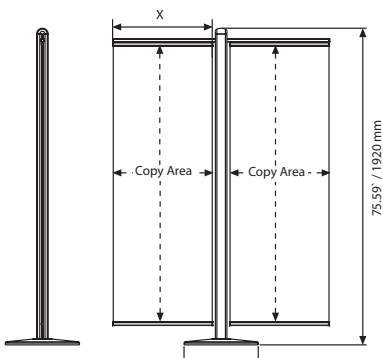

| MATERIAL : Silver anodized aluminum | | | | WEIGHT | PACKING SIZE |
|-------------------------------------|------------|--------------|--------|--------------|------------------------|
| SILVER | BLACK | EXTERNAL (x) | POSTER | WITH PACKING | *W X H X D |
| UFSL110011 | UFSL11B011 | 11" | 11" | 11.904 lbs | 9.06" X 13.39" X 5.51" |
| UFSL110014 | UFSL11B014 | 14" | 14" | 12.897 lbs | 17.32" X 9.06" X 5.51" |
| UFSL110018 | UFSL11B018 | 18" | 18" | 17.504 lbs | 9.06" X 21.26" X 5.51" |
| UFSL110022 | UFSL11B022 | 22" | 22" | 20.282 lbs | 9.06" X 25.20" X 5.51" |



*W:Width H: Height D: Depth

Display Stand Slide-in Frames



See movie at our website www.mtdisplays.com.tr

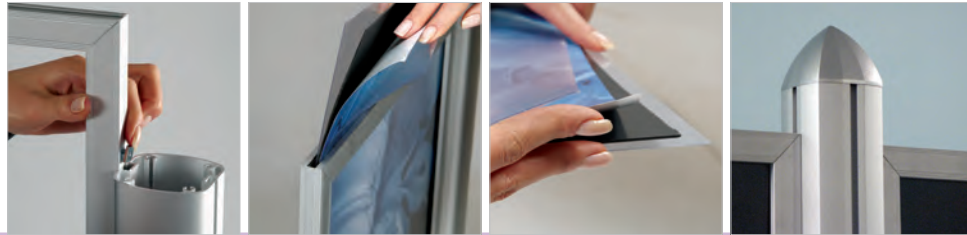

An ideal brochure stand that allows for various different models for indoor use.



Product is packed unasssembled with an easy mounting instruction sheet & fixing hardware.



Allows for multiple variations Heavy & stable base for public spaces.

Novel Free Standing
4 channel model



Free Standing
4 channel model



Free Standing
2 channel model

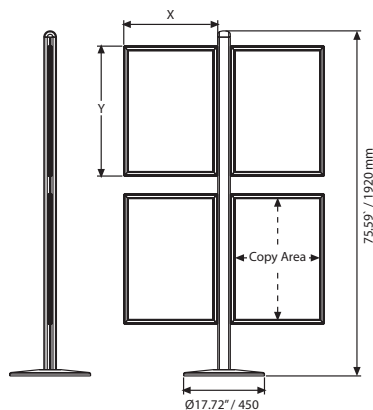
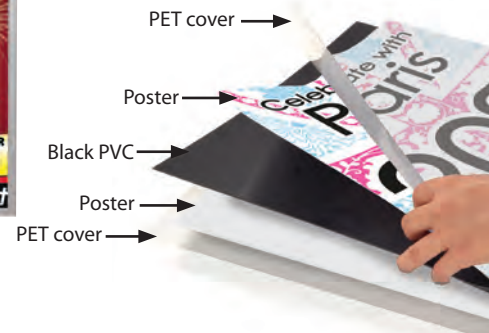

| MATERIAL : Silver anodized aluminum | | | | | WEIGHT | PACKING SIZE |
|-------------------------------------|------------|-----------------|------------|-----------------|--------------|--------------------|
| BLACK | SILVER | EXTERNAL (x-y) | POSTER | COPY | WITH PACKING | *W X H X D |
| UFSL13B081 | UFSL130081 | 9.41" X 11.91" | 8.5" X 11" | 7.44" X 9.94" | 1.7 lbs | 9.4" X 13" X 1" |
| UFSL13B017 | UFSL130017 | 11.91" X 17.91" | 11" X 17" | 9.94" X 15.94" | 2.6 lbs | 13" X 17.7" X 1" |
| UFSL13B014 | UFSL130014 | 14.91" X 22.91" | 14" X 22" | 12.94" X 20.94" | 4 lbs | 17.7" X 24.8" X 1" |
| UFSL13BD18 | UFSL130D18 | 18.91" X 24.91" | 18" X 24" | 16.94" X 22.94" | 6 lbs | 21.2" X 31.5" X 1" |
| UFSL13B700 | UFSL130700 | 22.91" X 28.91" | 22" X 28" | 20.94" X 26.94" | 6.2lbs | 21.2" X 28.8" X 1" |



* W:Width H: Height D: Depth

Poster Display Convex Boxes





See movie at our website www.mtdisplays.com.tr



Double sided display for indoor use. By the aid of snaps & hinged cover, one can easily change the poster on both sides. Brochure shelves can be added, if desired. Convex elegant look at eye-level to present your message.

 Product is packed unassembled with an easy to understand instruction sheet & fixing hardware.

 Heavy and stable base for public spaces. PVC hinged door, magnet cover & poster pegs provide easy change of poster on both sides.

 Shelves should be ordered separately.

 3 packs. See info chart for pack sizes.

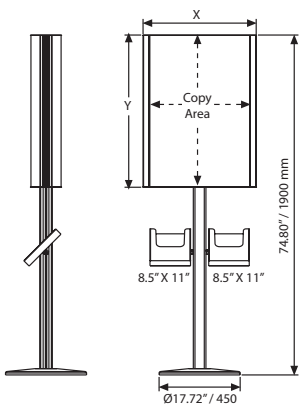

| MATERIAL : Silver anodized aluminum | | | | WEIGHT | PACKING SIZE |
|-------------------------------------|-----------------|-----------|-----------------|--------------|-------------------------|
| ARTICLE | EXTERNAL (x-y) | POSTER | COPY | WITH PACKING | *W X H X D |
| UTTM014301 | 19.57" X 25.57" | 18" X 24" | 17.13" X 23.13" | 29.762 lbs | 21.46" X 27.17" X 3.74" |
| UTTM014302 | 25.57" X 37.57" | 24" X 36" | 23.13" X 35.13" | 32.628 lbs | 23.82" X 31.50" X 3.74" |

*W:Width H: Height D: Depth



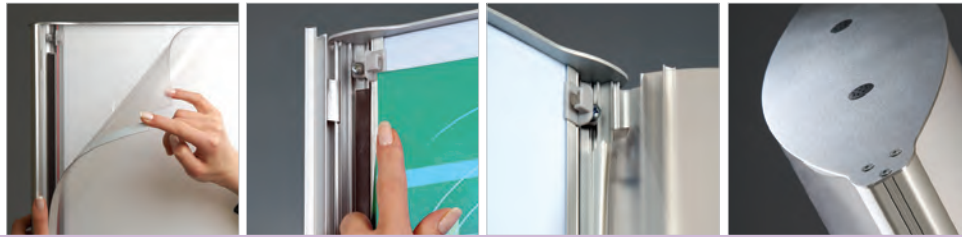

Totems



Stylish and practical free-standing light column. Illuminates posters printed on backlit film or duratrans. The snap frames enable you to change the display material easily whenever desired. Product is double sided. One can simply open the front profile to change the poster. The hinged door, magnetic cover closing & plastic pegs on both sides provide easy poster replacement.

 Each unit is packed unassembled with an easy instruction sheet. Delivered with 2 m electrical cable & plug.

 Each unit has a ventilation hole. PVC hinge on one side & magnetic cover allows for an easy change of the poster. All units have passed CE/UL Pat tests & are delivered with their certificates.

 2 packs. See info chart for pack sizes.

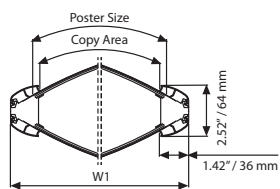
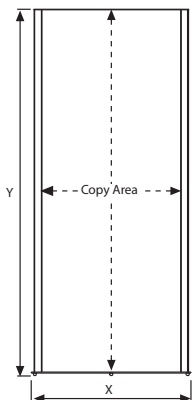
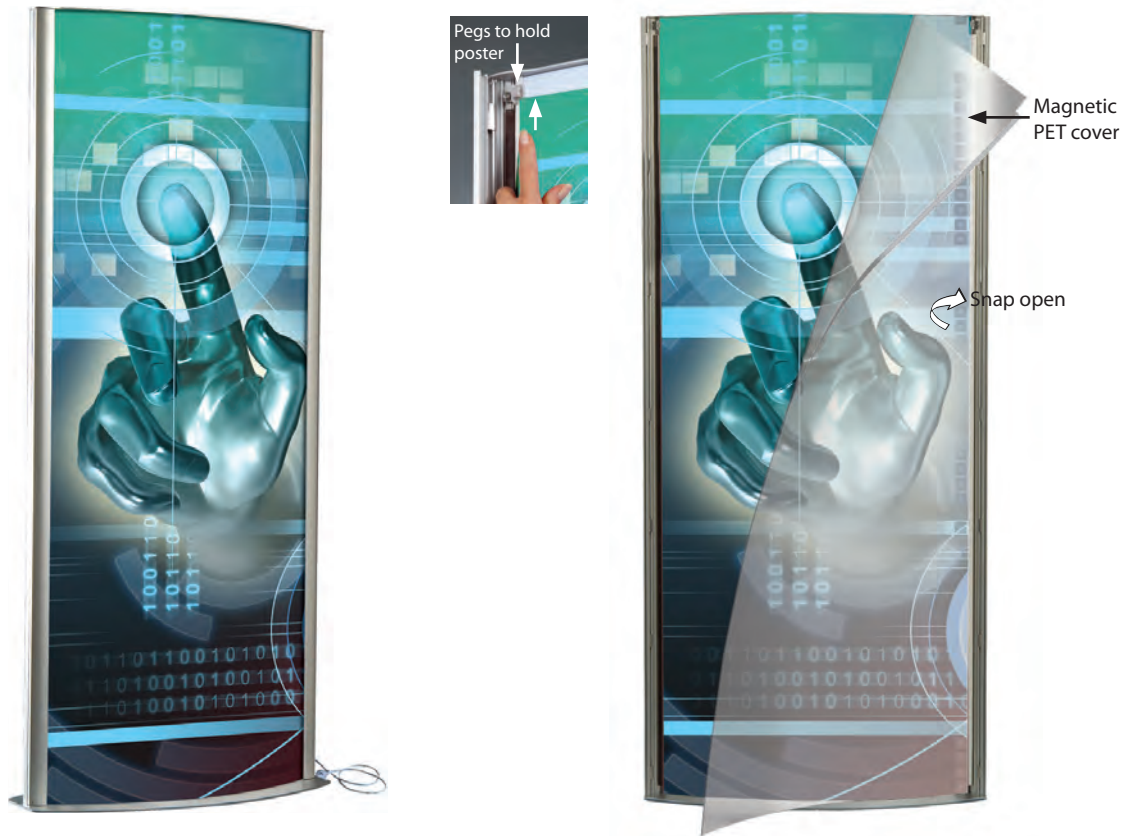

Top part
RAL 9006 grey
powdercoated

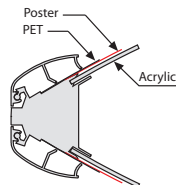
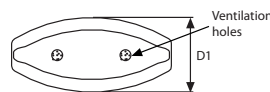

| MATERIAL : Silver anodized aluminum | | | | | | | WEIGHT | PACKING SIZE |
|-------------------------------------|-----------------|-----------|-----------------|--------|--------|---------------|--------------|---|
| ARTICLE | EXTERNAL (x-y) | POSTER | COPY | D1 | W1 | LIGHTING | WITH PACKING | *W X H X D |
| UTTM002767 | 28.97" X 68.97" | 27" X 67" | 26.21" X 66.21" | 13.58" | 29.13" | 2700-3300 LUX | 65.106 lbs | 30.91" X 46.06" X 3.74" / 14.57" X 30.12" X 1.57" |
| UTTM002777 | 28.97" X 78.97" | 27" X 77" | 26.21" X 76.21" | 13.58" | 29.13" | 2700-3300 LUX | 71.500 lbs | 30.91" X 80.71" X 3.35" / 14.57" X 30.12" X 1.57" |



*W:Width H: Height D: Depth



Decorative Totem



See movie at our website www.mtdisplays.com.tr



The elegant looking decorative Totem is designed with a patterned polystyrene panel at the bottom. The snap frames enable you to change the display material easily whenever desired. Product is double sided. One can simply open the front profile to change the poster. The hinged door, magnetic cover & plastic pegs on both sides, provide easy poster replacement.

-  Each unit is packed unassembled with an easy to understand instruction sheet. Delivered with 2 m electrical cable & plug.
-  PVC hinge on one side & magnetic cover allows for an easy change of the poster. All units have passed CE/UL Pat tests & are delivered with their certificates.
-  2 packs. See info chart for pack sizes.

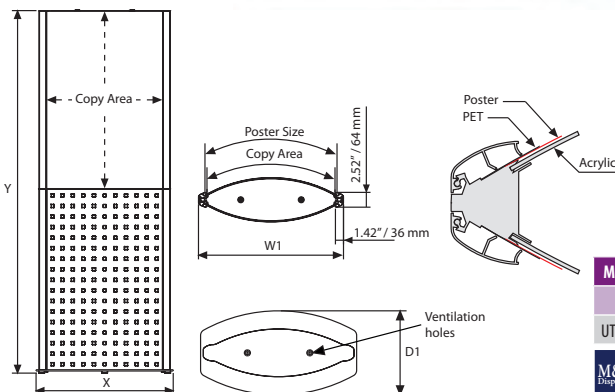
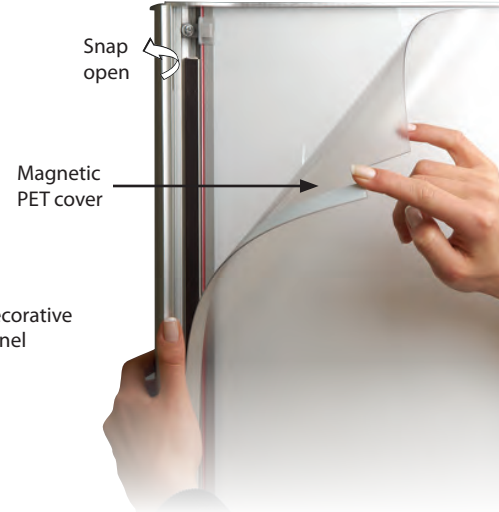

| MATERIAL : Silver anodized aluminum | | | | | | | WEIGHT | PACKING SIZE |
|-------------------------------------|-----------------|-----------|-----------------|--------|--------|---------------|--------------|------------------------|
| ARTICLE | EXTERNAL (x-y) | POSTER | COPY | D1 | W1 | LIGHTING | WITH PACKING | *W X H X D |
| UTTM011060 | 26.20" X 67.72" | 24" X 36" | 23.21" X 35.21" | 13.78" | 26.38" | 2800-3400 LUX | 39.38 lbs | 31.5" X 68.9" X 35.43" |





*W:Width H: Height D: Depth



Mono Totems



Non-snap Mono Totem is offered with and without light. Poster is placed on 2 long sides by slide-in profile channel. Available sizes are 19.6" x 67" and 23.6" x 67". Mono Totem is a double sided display. Smooth & durable aluminum construction provides stability. For illuminating options, please contact your Sales Executive.

-  Each unit is packed unassembled with an easy to understand instruction sheet and fixing hardware for assembly.
-  Heavy elegant base provides stability.
-  All illuminated items pass CE/UL tests and are delivered with certificates.
-  2 packs. See info chart for pack sizes.



Mono Totem



Mono Totem with Light

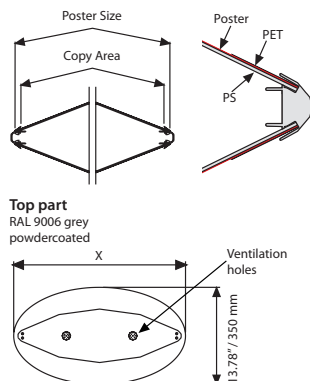
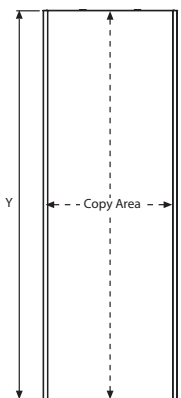

| MATERIAL : Silver anodized aluminum | | | | | WEIGHT | PACKING SIZE |
|-------------------------------------|----------------|-------------|-------------|---------------|--------------|---|
| ARTICLE | EXTERNAL (x-y) | POSTER | COPY | DESCRIPTION | WITH PACKING | *W X H X D |
| UTTME10500 | 20.5" X 67" | 19.5" X 67" | 18.5" X 67" | without light | 39.683 lbs | 22.44" X 68.90" X 2.36" / 14.57" X 21.26" X 1.57" |
| UTTME10600 | 24.5" X 67" | 23.5" X 67" | 22.5" X 67" | without light | 44.092 lbs | 26.38" X 68.90" X 2.36" / 14.57" X 25.20" X 1.57" |
| UTTME00500 | 20.5" X 67" | 19.5" X 67" | 18.5" X 67" | with light | 41.887 lbs | 22.44" X 68.90" X 2.36" / 14.57" X 21.26" X 1.57" |
| UTTME00600 | 24.5" X 67" | 23.5" X 67" | 22.5" X 67" | with light | 46.297 lbs | 26.38" X 68.90" X 2.36" / 14.57" X 25.20" X 1.57" |
| UTTME00000 | 23.2" X 67" | 27" X 67" | 25.8" X 67" | without light | 41.887 lbs | 29.72" X 67.72" X 2.36" / 14.57" X 25.20" X 1.57" |



*W:Width H:Height D:Depth

LEDA Illuminated Magnetic Totem



See movie at our website www.mtdisplays.com.tr

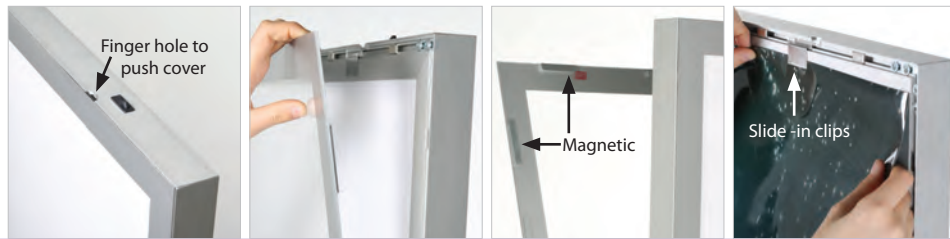

Indoor large display, LEDA is a slim LED illuminated totem. High quality LEDA provides bright images with high illumination. Magnetic acrylic cover has a hidden access so it prevents from public access easily. It is made of powder coated steel base and aluminium profiles to provide stability. Easy to assemble with enclosed mounting instructions.

All units pass CE/UL PAT tests and are supplied with their quality certificates. Delivered with 2,5 meter long cable and EU plug. UK and US plugs should be specified with order.

LED illumination saves up to 60% energy costs (compared to fluorescent technology).

Complete with low voltage 6A powersupply.

2 packs. See info chart for pack sizes.

Color options : Silver & black
Farbenoptionen : Schwarz und silber.



- Improved LED technology for improved luminance
- Pre-treated light guided panel diffuses light even & powerful.
- CE listed electrical components.
- Offers evenly diffused lux
- Saves up to 60% energy costs.

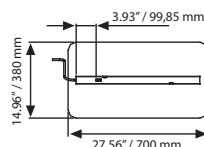
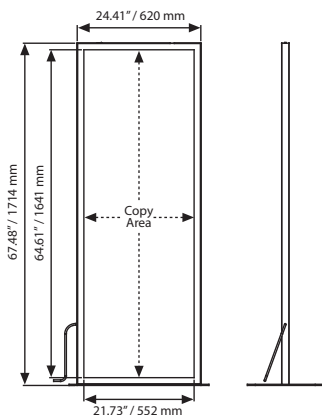

| MATERIAL : Silver & black anodised aluminium | | | | | | WEIGHT | PACKING SIZE |
|--|-------------|-----------------|-----------------|-----------------|---------------|--------------|---|
| ARTICLE | DESCRIPTION | EXTERNAL (x-y) | POSTER | COPY | LIGHTING | WITH PACKING | *W X H X D |
| UMLD37B000 | Black | 24.41" X 67.24" | 23.39" X 66.22" | 21.73" X 64.61" | 1900-2100 LUX | 91.491 lbs | 27.17" X 70.87" X 3.35" / 16.14" X 29.13" X 1.18" |
| UMLD37N000 | Silver | 24.41" X 67.24" | 23.39" X 66.22" | 21.73" X 64.61" | 1900-2100 LUX | 91.491 lbs | 27.17" X 70.87" X 3.35" / 16.14" X 29.13" X 1.18" |



*W:Width H:Height D:Depth

Totem LED Product Programme (Production & Availability)

| Size Available | LEDA Magnetic TOTEM | TOTEM | Decorative TOTEM | Mono TOTEM |
|---|---------------------|-----------------|------------------|-----------------|
| Product Size - Poster Size | double | double | double | double |
| 24.41" x 67.24" - 23.38" x 66.22" / Black | UMLD37B000 | X | X | X |
| 24.41" x 67.24" - 23.38" x 66.22" / White | UMLD37N000 | X | X | X |
| 22.04" x 67.71" - 19.68" x 27.56" | X | X | UTTM011040 | X |
| 25.59" x 67.71" - 23.62" x 66.93" | X | UTTM001000 | UTTM011010 | X |
| 29.52" x 67.71" - 27.56" x 66.93" | X | UTTM002000 | UTTM011020 | X |
| 33.46" x 67.71" - 31.49" x 66.93" | X | UTTM003000 | X | X |
| 34.64" x 67.71" - 33.11" x 46.81" | X | X | UTTM011030 | X |
| 20.47" x 66.93" - 19.68" x 66.93" / without light | X | X | X | UTTME10500 |
| 24.41" x 66.93" - 23.62" x 66.93" / without light | X | X | X | UTTME10600 |
| 20.47" x 66.93" - 19.68" x 66.93" / With light | X | X | X | UTTME00500 |
| 24.41" x 66.93" - 23.62" x 66.93" / With light | X | X | X | UTTME00600 |
| Max(w x h) inch | 27.56" x 78.74" | 31.49" x 78.74" | 34.64" x 67.71" | 27.56" x 78.74" |

| Power Consumption | LEDA Magnetic TOTEM | TOTEM | Decorative TOTEM | Mono TOTEM |
|---|---------------------|-----------------------|-----------------------|-------------------|
| Product Size - Poster Size | double | double | double | double |
| 24.41" x 67.24" - 23.38" x 66.22" / Black | 63W / 5,2A | X | X | X |
| 24.41" x 67.24" - 23.38" x 66.22" / White | 63W / 5,2A | X | X | X |
| 22.04" x 67.71" - 19.68" x 27.56" | X | X | 18W (fluorescent) | X |
| 25.59" x 67.71" - 23.62" x 66.93" | X | 58W (fluorescent) | 18W (fluorescent) | X |
| 29.52" x 67.71" - 27.56" x 66.93" | X | 58W (fluorescent) | 36W (fluorescent) | X |
| 33.46" x 67.71" - 31.49" x 66.93" | X | 2 x 58W (fluorescent) | X | X |
| 34.64" x 67.71" - 33.11" x 46.81" | X | X | 2 x 36W (fluorescent) | X |
| 20.47" x 66.93" - 19.68" x 66.93" / without light | X | X | X | 58W (fluorescent) |
| 24.41" x 66.93" - 23.62" x 66.93" / without light | X | X | X | 58W (fluorescent) |
| 20.47" x 66.93" - 19.68" x 66.93" / With light | X | X | X | 58W (fluorescent) |
| 24.41" x 66.93" - 23.62" x 66.93" / With light | X | X | X | 58W (fluorescent) |

| Power Supply Recommended (12 Vdc, Ampere) | LEDA Magnetic TOTEM | TOTEM | Decorative TOTEM | Mono TOTEM |
|---|---------------------|--------------------|--------------------|--------------------|
| Product Size - Poster Size | double | double | double | double |
| 24.41" x 67.24" - 23.38" x 66.22" / Black | 6A | X | X | X |
| 24.41" x 67.24" - 23.38" x 66.22" / White | 6A | X | X | X |
| 22.04" x 67.71" - 19.68" x 27.56" | X | X | Electronic Ballast | X |
| 25.59" x 67.71" - 23.62" x 66.93" | X | Electronic Ballast | Electronic Ballast | X |
| 29.52" x 67.71" - 27.56" x 66.93" | X | Electronic Ballast | Electronic Ballast | X |
| 33.46" x 67.71" - 31.49" x 66.93" | X | Electronic Ballast | X | X |
| 34.64" x 67.71" - 33.11" x 46.81" | X | X | Electronic Ballast | X |
| 20.47" x 66.93" - 19.68" x 66.93" / without light | X | X | X | Electronic Ballast |
| 24.41" x 66.93" - 23.62" x 66.93" / without light | X | X | X | Electronic Ballast |
| 20.47" x 66.93" - 19.68" x 66.93" / With light | X | X | X | Electronic Ballast |
| 24.41" x 66.93" - 23.62" x 66.93" / With light | X | X | X | Electronic Ballast |

| LUX | LEDA Magnetic TOTEM | TOTEM | Decorative TOTEM | Mono TOTEM |
|---|---------------------|-----------|------------------|------------|
| Product Size - Poster Size | double | double | double | double |
| 24.41" x 67.24" - 23.38" x 66.22" / Black | 1900-2100 | X | X | X |
| 24.41" x 67.24" - 23.38" x 66.22" / White | 1900-2100 | X | X | X |
| 22.04" x 67.71" - 19.68" x 27.56" | X | X | 1500-1900 | X |
| 25.59" x 67.71" - 23.62" x 66.93" | X | 1700-2000 | 1500-1800 | X |
| 29.52" x 67.71" - 27.56" x 66.93" | X | 1700-2000 | 1700-2000 | X |
| 33.46" x 67.71" - 31.49" x 66.93" | X | 2300-2700 | X | X |
| 34.64" x 67.71" - 33.11" x 46.81" | X | X | 1700-2000 | X |
| 20.47" x 66.93" - 19.68" x 66.93" / without light | X | X | X | 1900-2200 |
| 24.41" x 66.93" - 23.62" x 66.93" / without light | X | X | X | 1900-2200 |
| 20.47" x 66.93" - 19.68" x 66.93" / With light | X | X | X | 1900-2200 |
| 24.41" x 66.93" - 23.62" x 66.93" / With light | X | X | X | 1900-2200 |

- ✓ Standard colour: Silver Anodised
- ✓ Available in RAL colours (subject to MOQ)
- ✓ Power supply is provided with the unit to suit each of the product
- ✓ Luminance: 2000-3000lux (depending on size)
- ✓ Standard Packaging: Single units in polybag and box
- ✓ Low power consumption (see above average power consumption table for each size)
- ✓ Various plugs available such as European, UK, US and Australian
- ✓ Complies with EN55015 & EN61547.

| POWER SUPPLY | |
|--------------|----------------------------|
| ARTICLE | DESCRIPTION |
| UYPLD00010 | Power supply EU 3,34A 7/24 |
| UYPLD00011 | Power supply EU 6,67A 7/24 |
| UYPLD00012 | Power supply EU 8,5A 7/24 |
| UYPLD00013 | Power supply EU 11,5A 7/24 |

- ✓ Products are suitable to use 7/16.
- ✓ If 7/24 use required, please order individually as 7/24 power supplies as below:



In case of any claim, user is required to return product or any parts to manufacture for analyses at their cost. As long as the manufacturer confirms the problem is a manufacturing fault, the replacement can be provided. This applies for all illuminated products.





Literature Racks

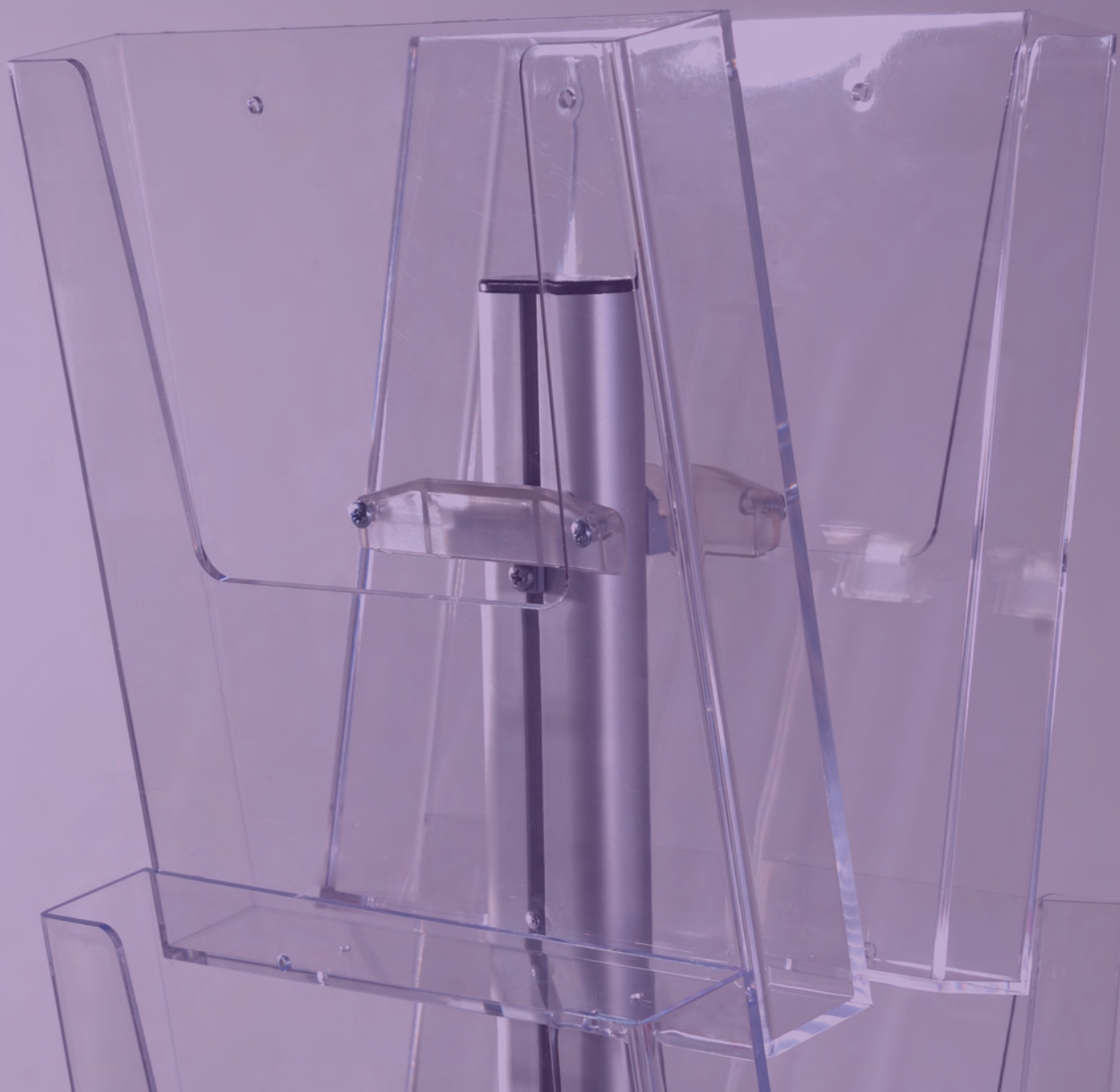

- Free Standing Leaflet with Side Shelves
- Cocktail Brochure Sets
- Cocktail Brochure Sets for Wall
- Portable Leaflet Dispensers
- Multiside Brochure Sets
- Brochure Sets
- Decorative Brochure Stands
- Decorative Brochure Stands Plus
- Pillar Brochure Stands
- Zick-Zacks
- Double Leg Zick-Zacks
- Zick-Zack Lites
- Rapid Brochure Set
- Curved Reversible Tower Brochure Stand
- Twin Reversible Tower Brochure Stand
- Convex Reversible Tower Brochure Stand
- Double Sided Reversible Tower Brochure Stand
- Basic Reversible Tower Brochure Stand
- Reversible Tower Brochure Stand for Wall
- Newage Portable Zick-Zacks
- Portable Zick-Zacks
- Wood Zick-Zack
- Monoblocks

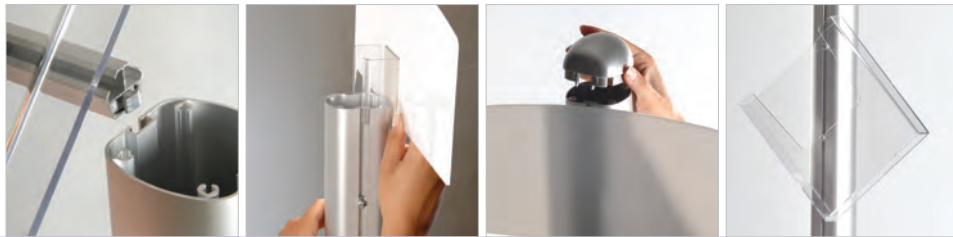

Free Standing Leaflet with Side Shelves



An ideal brochure stand that allows various different models for indoor use. The fixing grooves on both sides of the central pole hold slide-in frame one alone or more at the same time. Each Frame comes along with the required fixing components. The elegant look brochure holder is designed to hold maximally 8x8.5" X 11" brochure sets at a time. The acrylic logo header at size of 6.30 x 17.72".

-  Product is packed unasssembled with an easy mounting instruction sheet & fixing hardware.
-  Allows multiple variation, heavy & stable base for public space. Each slide-in frame includes a poster protective set of 2 clear + 1 black sheet which prevent the light transmission.
-  2 packs. See info chart for pack sizes.



Free Standing Leaflet with Side Shelves

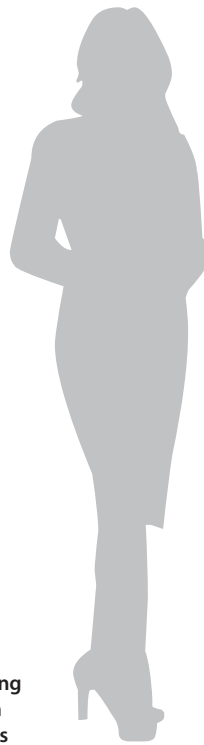

Free Standing Leaflet Dispensers

Free Standing Leaflet with Side Shelves

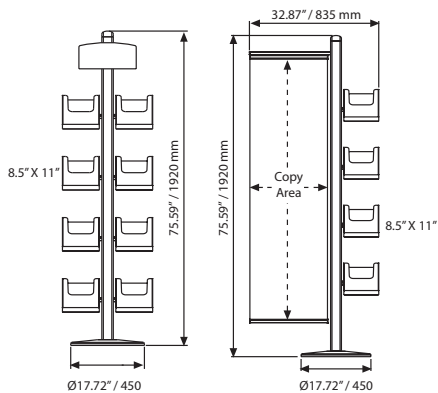

Free Standing Leaflet Dispensers

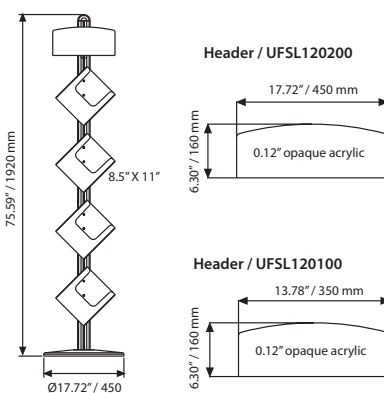

| LEAFLET DISPENSERS : Clear Acrylic | | | WEIGHT | PACKING SIZE |
|------------------------------------|----------------|----------------|--------------|-------------------------|
| ARTICLE | DESCRIPTION | SIZE | WITH PACKING | *W X H X D |
| UFSL120000 | Acrylic Shelf | 8.5" X 11" | 0.90 lbs | 10.63" X 9.65" X 2.17" |
| UFSL120100 | Header | 13.78" X 6.30" | 0.66 lbs | 7.68" X 14.37" X 0.87" |
| UFSL001000 | Main body pole | 75.59" | 7.60 lbs | 3.15" X 76.77" X 3.15" |
| | Main body base | Ø17.72" | 19.73 lbs | 19.29" X 19.29" X 1.97" |

| SIDE SHELF : Clear Acrylic | | | WEIGHT | PACKING SIZE |
|----------------------------|----------------|----------------|--------------|-------------------------|
| ARTICLE | DESCRIPTION | SIZE | WITH PACKING | *W X H X D |
| UFSL145000 | Acrylic Shelf | 8.5" X 11" | 1.82 lbs | 10.63" X 9.65" X 2.17" |
| UFSL120200 | Header | 17.72" X 6.30" | 0.66 lbs | 6.89" X 18.31" X 2.17" |
| UFSL001000 | Main body pole | 75.59" | 7.60 lbs | 3.15" X 76.77" X 3.15" |
| | Main body base | Ø17.72" | 19.73 lbs | 19.29" X 19.29" X 1.97" |



*W:Width H: Height D: Depth

Coctail Brochure Sets



See movie at our website www.mtdisplays.com.tr

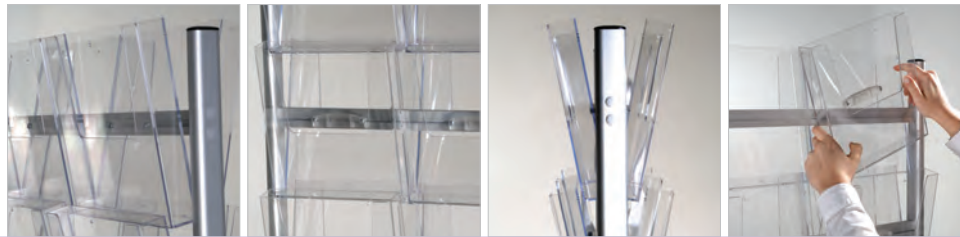

Easy to build, stylish brochure holder.
Designed to hold various brochures.
The connector structure offers you space for individual adjustment of the shelves.
Main body and required quantities of shelves need to be ordered separately.

Product is packed unassembled with an easy mounting instruction sheet & fixing hardware.

There are four plastic feet under the base.

Please gently push the shelves over the connectors on the pole. The shelf connectors arrive at fixed positions on the profile. For individual adjustment please loosen the screws to move back and forth.

2 packs. See info chart for pack sizes.

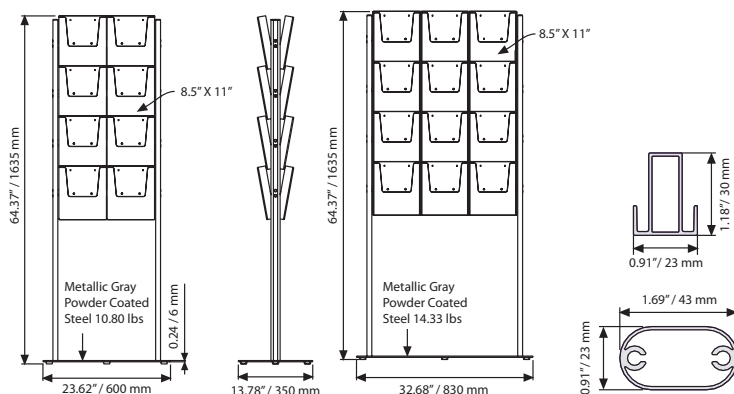

| MATERIAL : Silver anodized aluminum & acrylic shelf | | | WEIGHT | PACKING SIZE |
|---|-------------------------|------------------|--------------|----------------------------------|
| ARTICLE | DESCRIPTION | SIZE | WITH PACKING | *W X H X D |
| UCBSG00024 | Main body | 2 X (8.5" X 11") | 8.59 lbs | 20.67" X 64.57" X 2.17" |
| | | | 11.68 lbs | 15.16" X 24.80" X 1.18" |
| UCBSG00034 | Main body | 3 X (8.5" X 11") | 13.33 lbs | 29.53" X 64.57" X 2.17" |
| | | | 12.45 lbs | 15.16" X 33.86" X 1.18" |
| UMSDA008A4 | Acrylic Shelf & Adapter | 8 X (8.5" X 11") | 7.82 lbs | 10.63" X 13.39" X 9.45" (8 Pcs) |
| UMSD008100 | Acrylic Shelf | 8.5" X 11" | 28.43 lbs | 20.47" X 24.80" X 9.84" (30 Pcs) |
| UYUP490000 | Adapter | | 0.46 lbs | 10 Pcs |

*W:Width H: Height D: Depth



Coctail Brochure Sets for Wall



Stunning and Innovative brochure holders that are designed to hold various pieces of acrylic brochure holders side by side at a time.

 Product is packed unasssembled with an easy mounting instruction sheet & fixing hardware.

 Products is available in semi-finished index for various other applications.



2 pcs X 5.5" X 8.5"

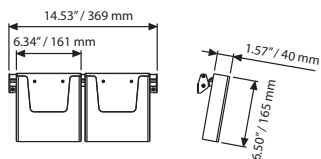

2 pcs x 8.5" X 11"

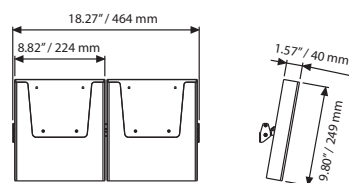

3 pcs X 4" X 6"

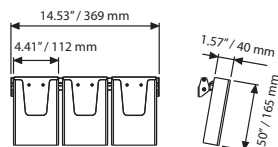

| MATERIAL : Clear Acrylic | | WEIGHT | PACKING SIZE |
|--------------------------|-------------|--------------|-------------------------|
| ARTICLE | POSTER | WITH PACKING | *W X H X D |
| UCBSW200A4 | 8.5" X 11" | 2.97 lbs | 10.63" X 19.69" X 3.54" |
| UCBSW200A5 | 5.5" X 8.5" | 1.87 lbs | 7.28" X 15.94" X 3.54" |
| UCBSW30A43 | 4" X 6" | 2.182 lbs | 7.28" X 15.94" X 3.54" |





*W:Width H: Height D: Depth

Portable Leaflet Dispensers



Made of polycarbonate, Portable Leaflet Dispensers provide both flexibility and saving from the space in the offices, shops and hotels and more. Transparent pockets offer a complete view of the brochure or fliers.

 Complete with fixing components.

 Additional pocket are available by order.



3 X (8.5"X11")



4 X (6.5"X8")



4 X (4"X9")

← Flexible scratch resistant PC body

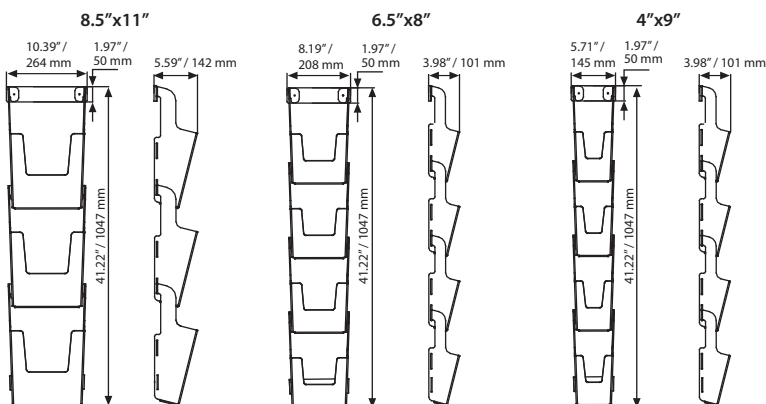

| MATERIAL : Polycarbonate | | WEIGHT | PACKING SIZE |
|--------------------------|------------------|--------------|-------------------------|
| ARTICLE | CAPACITY | WITH PACKING | *W X H X D |
| UPBW0030A4 | 3 X (8/5" X 11") | 2,579 lbs | 10.63" X 21.26" X 5.91" |
| UPBW0040A5 | 4 X (6.5" X 8") | 3,262 lbs | 5.91" X 21.26" X 4.72" |
| UPBW004A43 | 4 X (4" X 9") | 4,188 lbs | 8.46" X 21.26" X 4.72" |

*W:Width H:Height D:Depth



Multiside Brochure Sets 1 Pole



Multiside Brochure sets are developed to provide multiple variations at low costs. Based on 1, 3 or 4 poles, robust aluminum body with height of 1.5 meters, various number of shelves can be fitted to make a brochure set meeting your exact needs. To complete a product, main body and required quantities of shelves need to be ordered separately. Brochure holders are quickly and easily inserted.

Product is packed unassembled with an easy to understand instruction sheet & fixing hardware.

Heavy & stable base for public spaces. There are 4 plastic feet under the base.

Shelves should be ordered separate. Please gently push the shelves over the connectors on the pole. The shelf connectors arrive at fixed positions. For individual adjustment please loosen the screws to move up and down.UMSDA008100 and UYUP490000 can be used to form UMSDA005A4 if you have them in your stock.

2 packs. See info chart for pack sizes.



UMBLG20523

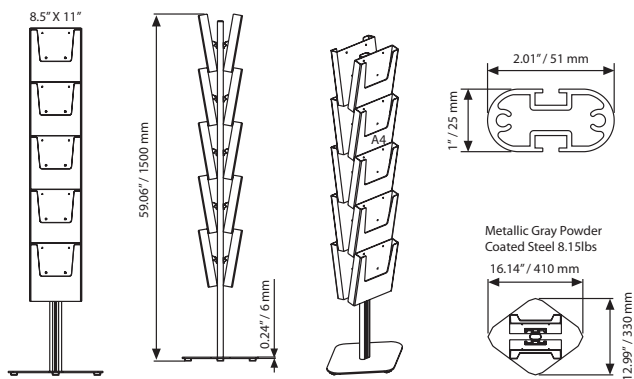

| MATERIAL : Anodized aluminum & clear acrylic | | | WEIGHT | PACKING SIZE |
|--|-------------------------|-------------------|----------------------|---|
| ARTICLE | DESCRIPTION | SIZE | WITH PACKING | *W X H X D |
| UMBSG205A4 | Main body | 5X (8.5" X 11") | 4.16 lbs 9.01 lbs | 2.56" X 59.84" X 2.56" 13.39" X 18.11" X 1.18" |
| UMBSG205A5 | Main body | 5 X (5.5" X 8.5") | 4.16 lbs 9.01 lbs | 2.56" X 59.84" X 2.56" 13.39" X 18.11" X 1.18" |
| UMBSG20523 | Main body | 5 X 2 (4" X 6") | 4.16 lbs 9.01 lbs | 2.56" X 59.84" X 2.56" 13.39" X 18.11" X 1.18" |
| UMSDA005A4 | Acrylic Shelf & Adapter | 8.5" X 11" | 5.51 lbs | 7.09" X 9.45" X 7.09" (5 Pcs) |
| UMSDA012A4 | Acrylic Shelf & Adapter | 8.5" X 11" | 13.22 lbs | 10.63" X 15.75" X 10.63" (12 Pcs) |
| UMSDA000A5 | Acrylic Shelf & Adapter | 5.5" X 8.5" | 7.05 lbs | 11.42" X 14.17" X 7.48" (12 Pcs) |
| UMSDA00A43 | Acrylic Shelf & Adapter | 4" X 6" | 5.62 lbs | 9.84" X 12.60" X 7.09" (12 Pcs) |
| UMSDA02A43 | Acrylic Shelf & Adapter | 2 X 4" X 6" | 9.60 lbs | 9.84" X 12.60" X 13.78" (12 Pcs) |







*W:Width H: Height D: Depth

Multiside Brochure Set 3 Pole - 4 Pole



Multiside Brochure sets are developed to provide multiple variations at low costs. Based on 3 pole or 4 pole robust aluminum body at height of 59.06" different number of shelves can be fitted to make a brochure set which meets your exact needs. To complete a product, main body and required quantities of shelves need to be ordered separately. Brochure holders are quickly and easily inserted.

-  Product is packed unassembled with an easy to understand instruction sheet & fixing hardware.
-  Heavy & stable base for public spaces. There are 4 plastic feet under the base.
-  Shelves should be ordered separate. Please gently push the shelves over the connectors on the pole. The shelf connectors arrive at fixed positions. For individual adjustment please loosen the screws to move up and down.UMSDA008100 and UYUP490000 can be used to form UMSDA005A4 if you have them in your stock.

 2 packs. See info chart for pack sizes.



3 Side Base
Metallic Gray Powder
Coated Steel 12.34 lbs

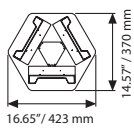

4 Side Base
Metallic Gray Powder
Coated Steel 19.18 lbs

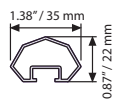
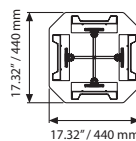

3 Side

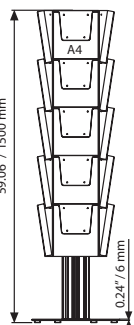

4 Side

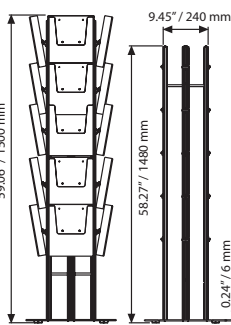

| MATERIAL : Anodized aluminum & clear acrylic | | | | WEIGHT 3 SIDE | PACKING SIZE 3 SIDE | WEIGHT 4 SIDE | PACKING SIZE 4 SIDE |
|--|-------------|-------------------------|-------------------|---------------|-----------------------------------|---------------|-----------------------------|
| 3 SIDE | 4 SIDE | DESCRIPTION | SIZE | WITH PACKING | *W X H X D | WITH PACKING | *W X H X D |
| UMBSG305A4 | UMBSG405A4 | Main body | 5X (8.5" X 11") | 4.16 lbs | 2.56" X 59.84" X 2.56" | 6.43 lbs | 11.42" X 59.84" X 4.13 mm |
| | | | | 9.01 lbs | 13.39" X 18.11" X 1.18" | 20.01 lbs | 18.11" X 18.11" X 1.18" |
| UMBSG305A5 | UMBSG405A5 | Main body | 5 X (5.5" X 8.5") | 4.16 lbs | 2.56" X 59.84" X 2.56" | 6.43 lbs | 11.42" X 59.84" X 4.13 mm |
| | | | | 9.01 lbs | 13.39" X 18.11" X 1.18" | 20.01 lbs | 18.11" X 18.11" X 1.18" |
| UMBSG30523 | UMBSG40523 | Main body | 5 X 2 (4" X 6") | 4.16 lbs | 2.56" X 59.84" X 2.56" | 6.43 lbs | 11.42" X 59.84" X 4.13 mm |
| | | | | 9.01 lbs | 13.39" X 18.11" X 1.18" | 20.01 lbs | 18.11" X 18.11" X 1.18" |
| UMSDA005A4 | UMSDA005A4 | Acrylic Shelf & Adapter | 8.5" X 11" | 5.51 lbs | 7.09" X 9.45" X 7.09" (5 Pcs) | 5.51 lbs | 180 X 240 X 180 mm (5 Pcs) |
| UMSDA012A4 | UMSDA012A4 | Acrylic Shelf & Adapter | 8.5" X 11" | 13.22 lbs | 10.63" X 15.75" X 10.63" (12 Pcs) | 13.22 lbs | 270 X 400 X 270 mm (12 Pcs) |
| UMSDA000A5 | UMSDA000A5 | Acrylic Shelf & Adapter | 5.5" X 8.5" | 7.05 lbs | 11.42" X 14.17" X 7.48" (12 Pcs) | 7.05 lbs | 290 X 360 X 190 mm (12 Pcs) |
| UMSDA000A43 | UMSDA000A43 | Acrylic Shelf & Adapter | 4" X 6" | 5.62 lbs | 9.84" X 12.60" X 7.09" (12 Pcs) | 5.62 lbs | 250 X 320 X 180 mm (12 Pcs) |
| UMSDA02A43 | UMSDA02A43 | Acrylic Shelf & Adapter | 2 X 4" X 6" | 9.60 lbs | 9.84" X 12.60" X 13.78" (12 Pcs) | 9.60 lbs | 250 X 320 X 350 mm (12 Pcs) |

*W:Width H: Height D: Depth





Multiside Brochure Set on Wheels



Multiside Brochure sets are developed to provide multiple variations at low costs. Based on 1 pole, 3 pole or 4 pole robust aluminium body at height of 62.99" meter, any number of shelves can be fitted to make a brochure set which meets your exact needs. To make a complete product, main body and required quantities of shelves need to be ordered separately. Product is freely rotatable and mobile in all directions over the wheels of the base providing flexibility in brochure presentation.

 Product is packed unassembled with an easy mounting instruction sheet & fixing set.

 Mobile & stable base for public space. There are 5 smooth rolling wheels under the base.

 Shelves should be ordered separate. Please gently push the shelves over the connectors on the pole. The shelf connectors arrive at fixed positions. For individual adjustment please loosen the screws to move up and down. UMSDA008100 and UYUP490000 can be used to form UMSDA005A4 if you have them in your stock.

 Color options :
Silver-anodized & black



1 Pole Black



3 Pole Black



3 Pole Silver

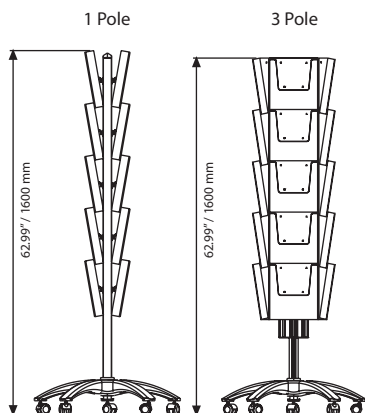
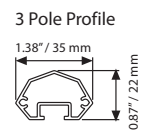
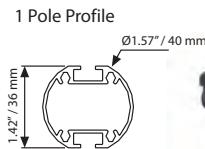

| MATERIAL : Aluminum & clear acrylic | | | |
|-------------------------------------|------------|-------------------------|------------------|
| 1 POLE | 3 POLE | DESCRIPTION | SIZE |
| UMBSG2T5A4 | UMBSG3T5A4 | Silver main body | 5 X (8.5" X 11") |
| UMBBG2T5A4 | UMBBG3T5A4 | Black main body | 5 X (8.5" X 11") |
| UMSDA005A4 | UMSDA005A4 | Acrylic Shelf & Adapter | 8.5" X 11" |
| UMSDA012A4 | UMSDA012A4 | Acrylic Shelf & Adapter | 8.5" X 11" |
| UMSDA000A5 | UMSDA000A5 | Acrylic Shelf & Adapter | 5.5" X 8.5" |
| UMSDA00A43 | UMSDA00A43 | Acrylic Shelf & Adapter | 4" X 6" |
| UMSDA02A43 | UMSDA02A43 | Acrylic Shelf & Adapter | 2 X 4" X 6" |

| 1 POLE | | 3 POLE | |
|--------------|-----------------------------------|--------------|-----------------------------------|
| WEIGHT | PACKING SIZE | WEIGHT | PACKING SIZE |
| WITH PACKING | *W X H X D | WITH PACKING | *W X H X D |
| 4.16 lbs | 27.56" X 60.24" X 2.76" | 4.18 lbs | 6.69" X 52.36" X 5.75" |
| 6.61 lbs | 27.95" X 28.35" X 7.32" | 8.60 lbs | 27.95" X 28.35" X 7.32" |
| 5.51 lbs | 70.9 X 9.45" X 7.09" (5 Pcs) | 5.51 lbs | 70.9 X 9.45" X 7.09" (5 Pcs) |
| 13.22 lbs | 10.63" X 15.75" X 10.63" (12 Pcs) | 13.22 lbs | 10.63" X 15.75" X 10.63" (12 Pcs) |
| 7.05 lbs | 11.42" X 14.17" X 7.48" (12 Pcs) | 7.05 lbs | 11.42" X 14.17" X 7.48" (12 Pcs) |
| 5.62 lbs | 9.84" X 12.60" X 7.09" (12 Pcs) | 5.62 lbs | 9.84" X 12.60" X 7.09" (12 Pcs) |
| 9.60 lbs | 9.84" X 12.60" X 13.78" (12 Pcs) | 9.60 lbs | 9.84" X 12.60" X 13.78" (12 Pcs) |

*W:Width H: Height D: Depth



Multiside Brochure Set Rotating



4 sided floor display, rotating on a central column which is mounted on a stable and elegant base. Height is 62.99", available in black and silver main body options. Shelves are clear in 8.5" X 11" all the time. Multiside Brochure sets have been developed to provide multiple variations at low costs. Different number of shelves can be fitted to make a brochure set which meets your exact needs.

Product is packed unasssembled with an easy mounting instruction sheet & fixing hardware.

Heavy & stable base for public space. While the main body is rotatable, the robust base is stable and still.

Shelves should be ordered separate. Please gently push the shelves over the connectors on the pole. The shelf connectors arrive at fixed positions. For individual adjustment please loosen the screws to move up and down. UMSD008100 and UYUP490000 can be used to form UMSDA008A4 if you have them in your stock.

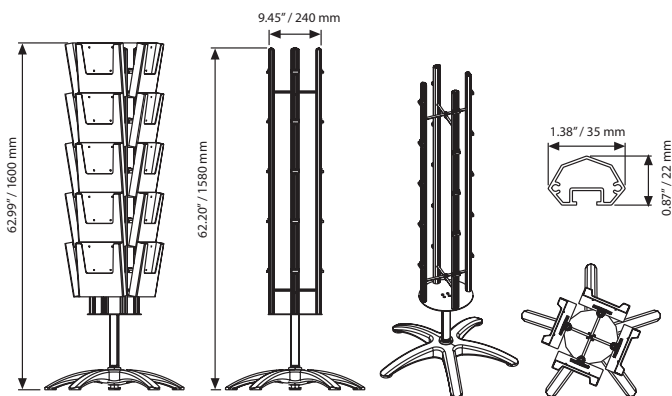
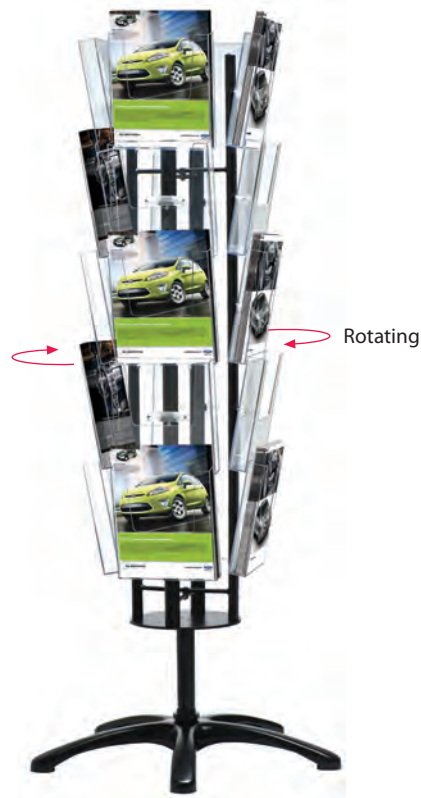

| MATERIAL : Aluminum & clear acrylic | | | WEIGHT | PACKING SIZE |
|-------------------------------------|-------------------------|------------------|--------------|-----------------------------------|
| ARTICLE | DESCRIPTION | SIZE | WITH PACKING | *W X H X D |
| UMBSG4D5A4 | Silver main body | 5 X (8.5" X 11") | 6.43 lbs | 11.42" X 59.84" X 4.13" |
| UMBBG4D5A4 | Black main body | 5 X (8.5" X 11") | 20.01 lbs | 18.11" X 18.11" X 1.18" |
| UMSDA005A4 | Acrylic Shelf & Adapter | 8.5" X 11" | 5.51 lbs | 70.9 X 9.45" X 7.09" (5 Pcs) |
| UMSDA012A4 | Acrylic Shelf & Adapter | 8.5" X 11" | 13.22 lbs | 10.63" X 15.75" X 10.63" (12 Pcs) |
| UMSDA000A5 | Acrylic Shelf & Adapter | 5.5" X 8.5" | 7.05 lbs | 11.42" X 14.17" X 7.48" (12 Pcs) |
| UMSDA000A3 | Acrylic Shelf & Adapter | 4" X 6" | 5.62 lbs | 9.84" X 12.60" X 7.09" (12 Pcs) |
| UMSDA02A43 | Acrylic Shelf & Adapter | 2 X 4" X 6" | 9.60 lbs | 9.84" X 12.60" X 13.78" (12 Pcs) |





*W:Width H: Height D: Depth

Brochure Sets



A brochure holder designed to hold brochures. When used with 4 wheels it is free and mobile. Single or double-faced options are available. Transparent shelves are made of 0.16" acrylic, the legs are made of aluminum.

 Product is packed unassembled with an easy to understand instruction sheet & fixing hardware.

 Wheels are optional, not included in the original pack. Shelves are packed separate in a protected box.



16 X 8.5" X 11" double sided



12 X 8.5" X 11" single sided



For wall

for Wall

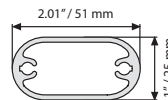
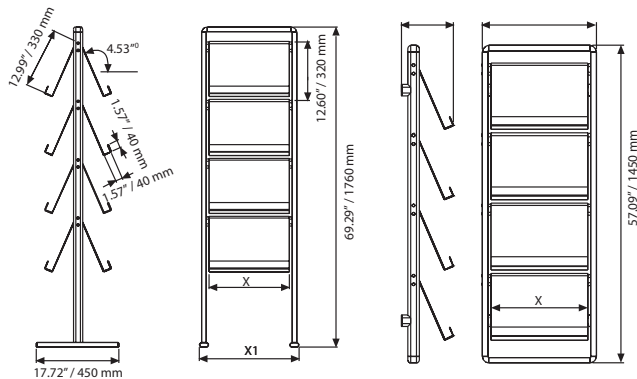

| FOR WALL : Silver anodized aluminum & acrylic shelf | | | |
|---|------------------|--------------|-------------------------|
| ARTICLE | CAPACITY | WEIGHT | PACKING SIZE |
| | | WITH PACKING | *W X H X D |
| UBSSD10N24 | 8 X (8.5" X 11") | 28.660 lbs | 21.65" X 59.06" X 5.12" |

| MATERIAL : Silver anodized aluminum & acrylic shelf | | | | WEIGHT | PACKING SIZE |
|---|--------------------------------|--------|--------|--------------|--------------------------------|
| ARTICLE | CAPACITY | X | X1 | WITH PACKING | *W X H X D |
| | | | | UBSSC10N24 | 16 X (8.5" X 11") double sided |
| UBBST10N24 | 8 X (8.5" X 11") single sided | 17.32" | 21.50" | 27.447 lbs | 22.05" X 70.08" X 2.76" |
| UBSSC10N34 | 24 X (8.5" X 11") double sided | 25.98" | 30.16" | 20.392 lbs | 30.71" X 70.08" X 3.15" |
| UBBST10N34 | 12 X (8.5" X 11") single sided | 25.98" | 30.16" | 34.943 lbs | 30.71" X 70.08" X 2.76" |
| UBSSC10N44 | 32 X (8.5" X 11") double sided | 34.65" | 38.82" | 24.802 lbs | 39.37" X 70.08" X 3.15" |
| UBBST10N44 | 16 X (8.5" X 11") single sided | 34.65" | 38.82" | 42.769 lbs | 39.37" X 70.08" X 2.76" |

* W:Width H: Height D: Depth



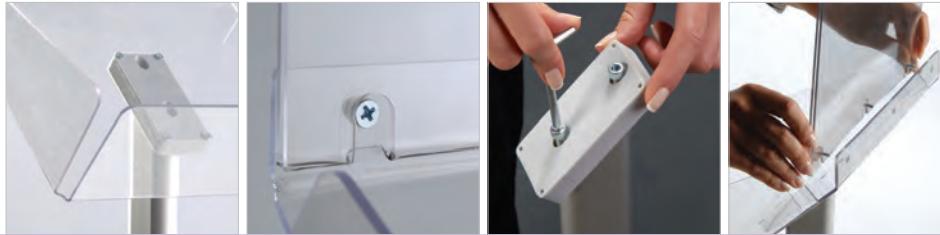

Decorative Brochure Stands

Decorative Brochure Stands Plus



Available in 8.5" x 11" size in portrait & landscape positions. Decorative Brochure Stand Plus is delivered with easy to change header on top.

 Brochure holders are made of 3 mm polycarbonate. Hard to scratch, not easy to break. Decorative brochures are packed unassembled with an easy to understand instruction sheet & fixing hardware.

 Heavy stable base for public spaces.



8.5" X 11" landscape

8.5" X 11" landscape with logo

8.5" X 11" portrait

8.5" X 11" portrait with logo

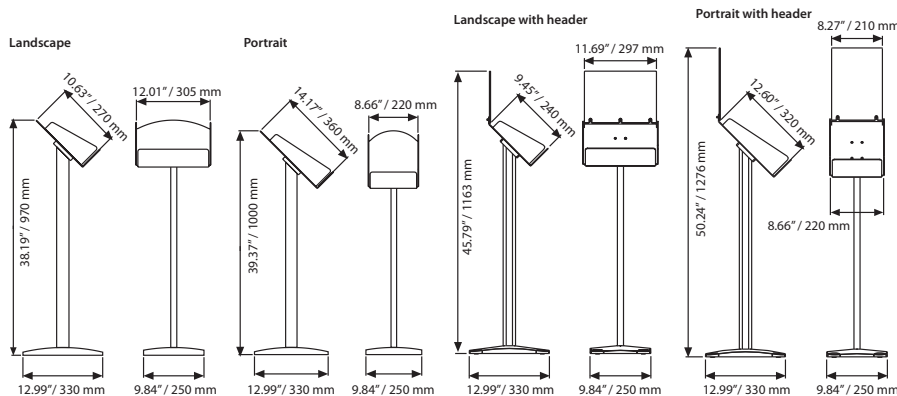

| MATERIAL : Silver anodized aluminum & acrylic | | | |
|---|--------------------------------|---------------------|-------------------------|
| ARTICLE | DESCRIPTION | WEIGHT WITH PACKING | PACKING SIZE *W X H X D |
| UDBS20Y0A4 | 8.5" X 11" landscape with logo | 8.774 lbs | 11.02" X 34.65" X 4.92" |
| UDBS20D0A4 | 8.5" X 11" portrait with logo | 8.774 lbs | 11.02" X 34.65" X 4.92" |
| UDBS10Y0A4 | 8.5" X 11" landscape | 7.605 lbs | 11.02" X 34.65" X 4.92" |
| UDBS10D0A4 | 8.5" X 11" portrait | 7.605 lbs | 11.02" X 34.65" X 4.92" |

*W:Width H: Height D: Depth



Pillar Brochure Stand

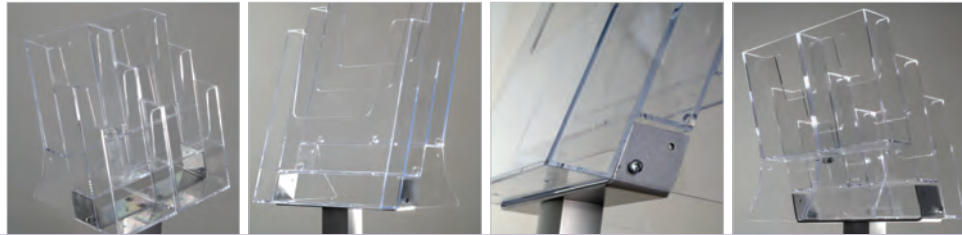

New selection of literature display including injected counter top with a robust aluminum body. 3 x 8.5" x 11" capacity and 6 x 4" x 6" capacity standards are available.

- Packed unassembled with instruction sheet & fixing hardware.
- Heavy stable base for public spaces.

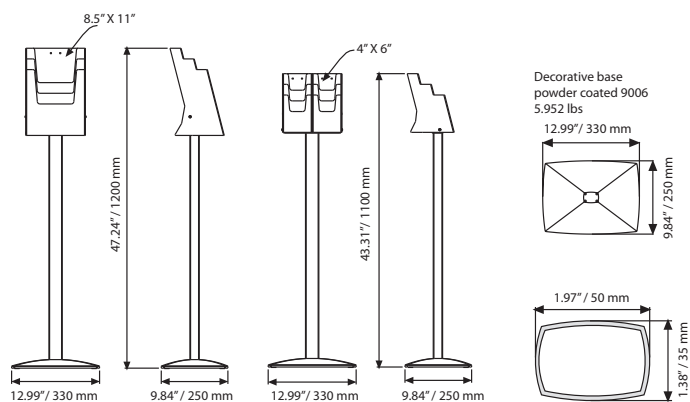

| MATERIAL : Silver anodized aluminum & acrylic | | | |
|---|------------|--------------|-------------------------|
| ARTICLE | SIZE | WEIGHT | PACKING SIZE |
| | | WITH PACKING | *W X H X D |
| UPBS3000A4 | 8.5" X 11" | 9.325 lbs | 10.63" X 16.54" X 7.48" |
| | | 1.807 lbs | 2.76" X 34.25" X 1.77" |
| UPBS300A43 | 4" X 6" | 8.972 lbs | 10.63" X 20.47" X 7.48" |
| | | 1.807 lbs | 2.76" X 34.25" X 1.77" |



*W:Width H: Height D: Depth

Zick-Zacks



Decorative legs are made of silver anodized aluminum ellipse profile, shelves are made of 0.39" acrylic. Metallic powder coated base is made up of 0.31" aluminum metallic powder coated base.

- Product comes unassembled with instruction sheet.
- Easy to change header. Heavy stable base is suitable for public spaces.
- Use the hole caps in the hardware set to cover the mounting holes.
- 2 packs. See info chart for pack sizes.

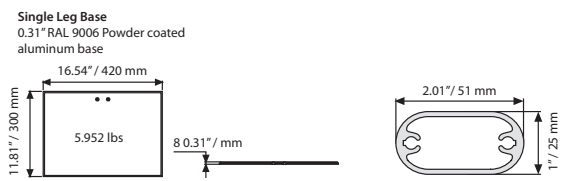
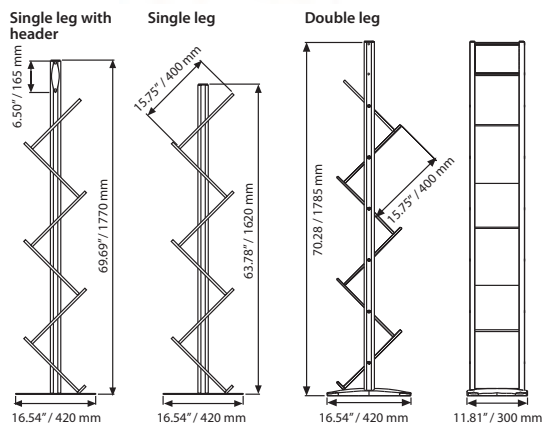
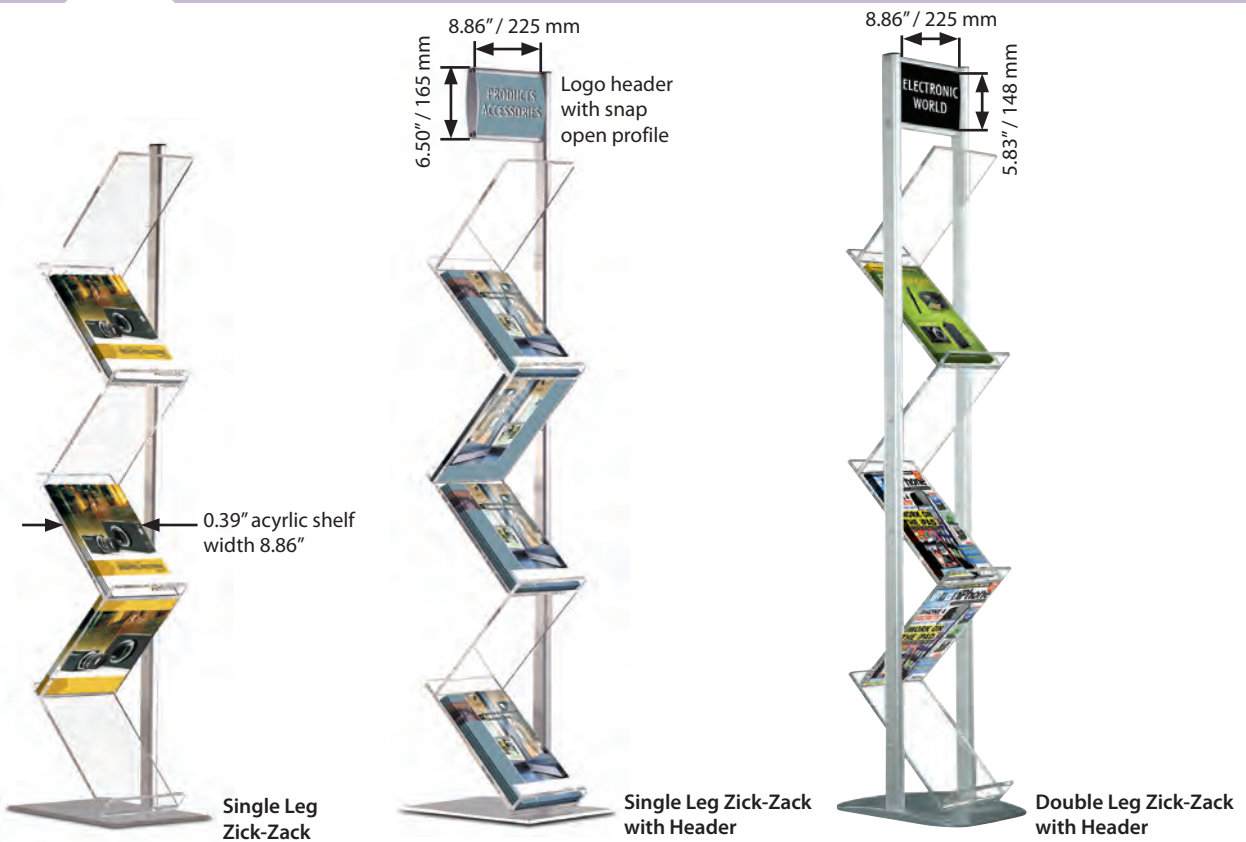



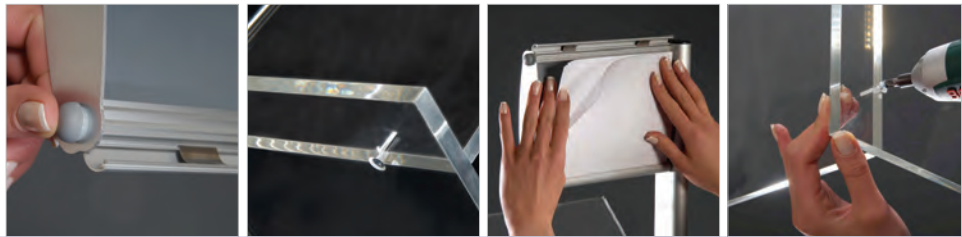

| MATERIAL : Silver anodized aluminum | | SHELF : Acrylic | | | |
|-------------------------------------|------------------------|------------------|---------------------|-------------------------|------------------------|
| ARTICLE | MODELS | CAPACITY | WEIGHT WITH PACKING | SHELF & BASE | PACKING SIZE |
| UZZTAC1001 | Single leg | 6 X (8.5" X 11") | 25.022 lbs | 12.99" X 17.32" X 5.12" | 2.76" X 65.75" X 1.97" |
| UZZTAC1002 | Single leg with header | 6 X (8.5" X 11") | 25.353 lbs | 12.99" X 17.32" X 5.12" | 2.76" X 71.65" X 1.97" |
| UZZCAC1002 | Double Leg | 6 X (8.5" X 11") | 29.431 lbs | 12.99" X 17.32" X 5.12" | 2.76" X 71.65" X 1.97" |

*W:Width H: Height D: Depth

Zick-Zack Lites



Zick-Zack Lites are developed to provide 6 x (8.5"x11"), 8.5"x11" catalogs at one time. Based on metallic powder coated, semi-metal, plastic coated base; product stands stable on the floor in public places. Metallic color base is 9.479 lbs and transparent acrylic shelves are 0.31".

-  Product comes unassembled with instruction sheet.
-  Easy to change header. Heavy stable base is suitable for public spaces.
-  Use the hole caps in the hardware set to cover the mounting holes.
-  2 packs. See info chart for pack sizes.

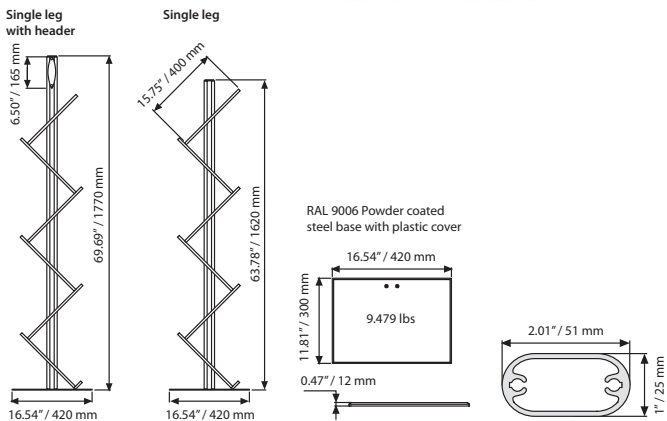
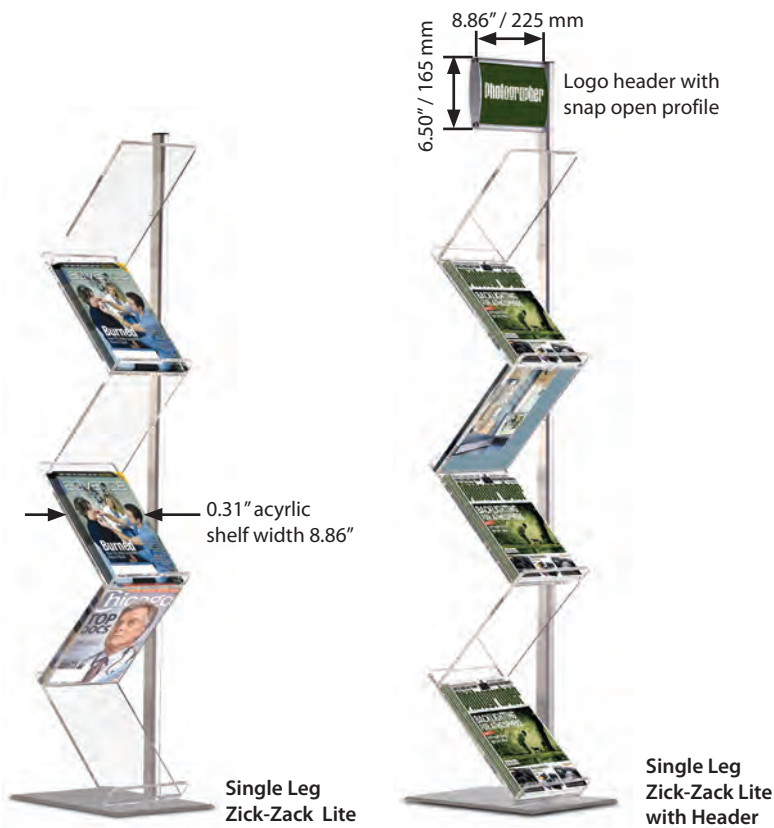

| MATERIAL : Silver anodized aluminum | | SHELF : Acrylic | | | |
|-------------------------------------|------------------------|------------------|--------------|-------------------------|------------------------|
| | | WEIGHT | | PACKING SIZE | |
| ARTICLE | MODELS | CAPACITY | WITH PACKING | SHELF & BASE | ELIPS PROFILE |
| UZZTLT0001 | Single leg | 6 X (8.5" X 11") | 27.557 lbs | 12.99" X 17.32" X 5.12" | 2.76" X 65.75" X 1.97" |
| UZZTLT0002 | Single leg with header | 6 X (8.5" X 11") | 27.557 lbs | 12.99" X 17.32" X 5.12" | 2.76" X 71.65" X 1.97" |

*W:Width H: Height D: Depth



Rapid Brochure Sets



Rapid Brochure set has a stylish look. 8.5" X 11" shelves are made of frosted acrylic and easily placed on the aluminum poles. Boxed flat with unassembled shelves, it guarantees easy and safe transportation. Display your leaflets in retail stores or merchandising settings with Rapid brochure Sets. Header consists of 2 pieces. Front piece is clear and the back piece is frosted acrylic. You can put your paper poster in between the acrylics or apply printing directly on the clear or frosted acrylic pieces.

 Shelves are made of 4 mm frosted acrylic aluminum feet are powder coated.

 No tool assembly, easy to install & ready to use.

Color options



Silver Black



2 x 8.5" x 11" Silver

2 x 8.5" x 11" Black



3 x 8.5" x 11" Silver

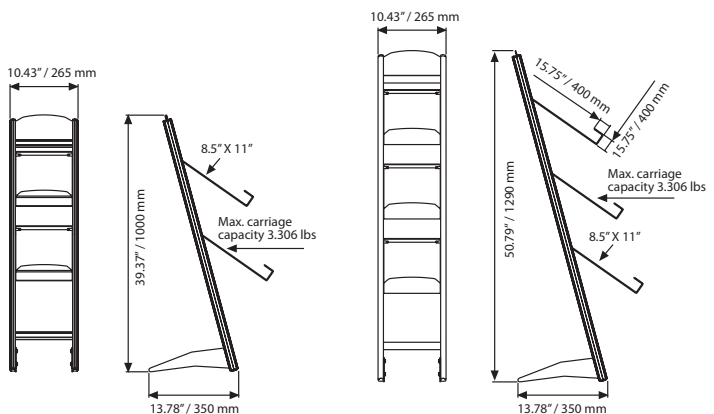

Header

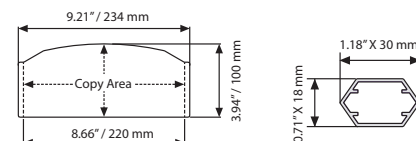

MATERIAL : Silver and black anodized

| aluminum & acrylic | | WEIGHT | PACKING SIZE |
|--------------------|------------|------------------|-----------------------------------|
| SILVER | BLACK | WITH PACKING | *W X H X D |
| URDB0002A4 | URDBB002A4 | 2 X (8.5" X 11") | 7.936 lbs 11.02" X 41.73" X 2.17" |
| URDB0003A4 | URDBB003A4 | 3 X (8.5" X 11") | 9.810 lbs 11.02" X 54.72" X 2.17" |



*W:Width H: Height D: Depth

Convex Reversible Tower Brochure Stand



See movie at our website www.mtdisplays.com.tr

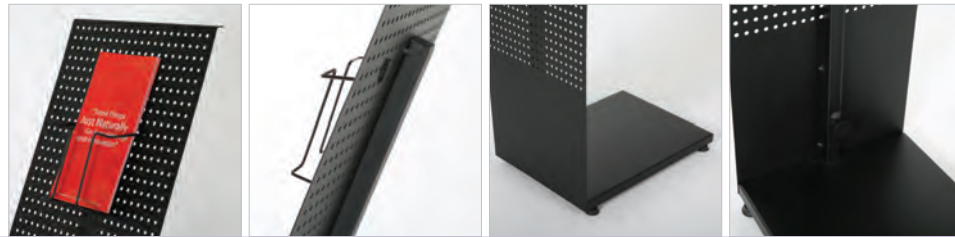

This single sided brochure stand is suitable for use indoor. It has an elegant curved design. Holes on the stand allows personalization of brochure placement and size according to need. 8.5"x11", 5.5"x8.5", 5"x7", 4"x6", 5.91" brochure holders are available. Quite stable with both its heavy base and design. Smooth lower part of brochure stand allows for branding. Curved Tower Stand is ideal for use at reception areas, educational institutions, travel agencies, hotels, offices, marketing events.

Product is packed unassembled with an easy to understand instruction sheet for assembly.

Make your own stand design with desired variation of brochure holder placement and size.

Brochure holders should be ordered separately.

Color options



Silver Black



Magnetic Pet Pocket
Please don't forget to order

| PET POCKET | | |
|------------|-------------|--------|
| PET POCKET | SIZE | COLOUR |
| UPCMOR00A4 | 8.5" X 11" | Red |
| UPCMOB00A4 | 8.5" X 11" | Black |
| UPCMOW00A4 | 8.5" X 11" | White |
| UPCMOG00A4 | 8.5" X 11" | Grey |
| UPCMOG00A5 | 5.5" X 8.5" | Grey |
| UPCMOB00A5 | 5.5" X 8.5" | Black |

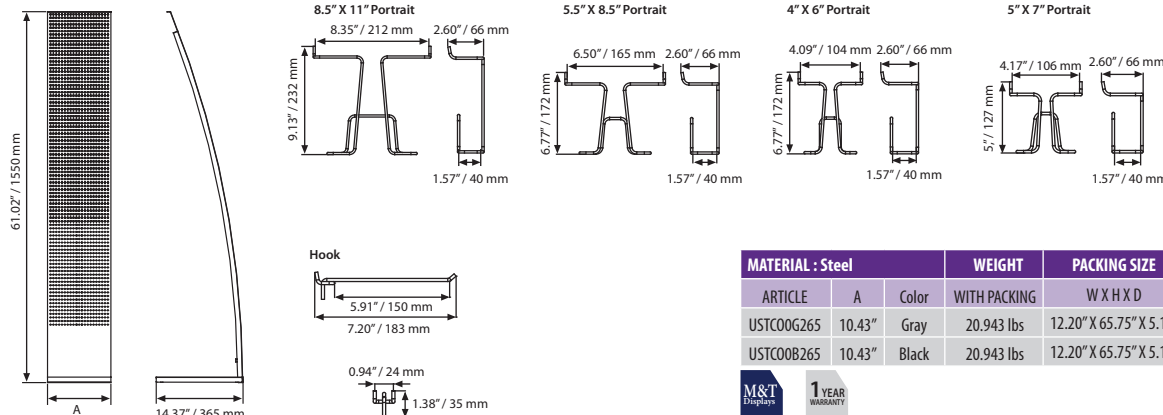

| SHELF : Steel | | |
|---------------|-------------|-------|
| ARTICLE | SIZE | Color |
| UYPTSG00A4 | 8.5" X 11" | Gray |
| UYPTSB00A4 | 8.5" X 11" | Black |
| UYPTSG00A5 | 5.5" X 8.5" | Gray |
| UYPTSB00A5 | 5.5" X 8.5" | Black |
| UYPTSG00A6 | 5" X 7" | Gray |
| UYPTSB00A6 | 5" X 7" | Black |
| UYPTSG0A43 | 4" X 6" | Gray |
| UYPTSB0A43 | 4" X 6" | Black |
| UYPTSG0015 | 5.91" | Gray |
| UYPTSB0015 | 5.91" | Black |

| MATERIAL : Steel | | | WEIGHT | PACKING SIZE |
|------------------|--------|-------|--------------|-------------------------|
| ARTICLE | A | Color | WITH PACKING | W X H X D |
| USTCOOG265 | 10.43" | Gray | 20.943 lbs | 12.20" X 65.75" X 5.12" |
| USTCOOB265 | 10.43" | Black | 20.943 lbs | 12.20" X 65.75" X 5.12" |



* W:Width H: Height D: Depth

Double Sided Reversible Tower Brochure Stand



See movie at our website www.mtdisplays.com.tr



This double sided brochure Stand can be used indoor. Two straight modules back to back provides space for more brochure holders. Holes on the stand allows personalization of brochure placement and size according to needs. 8.5"x11", 5.5"x8.5", 5"x7", 4"x6", 5.91" brochure holders are available. Quite stable with both its heavy base and design. Smooth lower part of brochure stand allows for branding. Ideal for use at reception areas, educational institutions, travel agencies, hotels, offices, marketing events.

- Product is packed unassembled with an easy to understand instruction sheet for assembly.
- Make your own stand design with desired variation of brochure holder placement and size.
- Brochure holders should be ordered separately.
- 2 packs. See info chart for pack sizes.

Color options



RAL powder coated



Magnetic Pet Pocket
Please don't forget to order

| PET POCKET | | |
|------------|-------------|--------|
| PET POCKET | SIZE | COLOUR |
| UPCMOR00A4 | 8.5" X 11" | Red |
| UPCMB00A4 | 8.5" X 11" | Black |
| UPCMOW00A4 | 8.5" X 11" | White |
| UPCMOG00A4 | 8.5" X 11" | Grey |
| UPCMOG00A5 | 5.5" X 8.5" | Grey |
| UPCMB00A5 | 5.5" X 8.5" | Black |

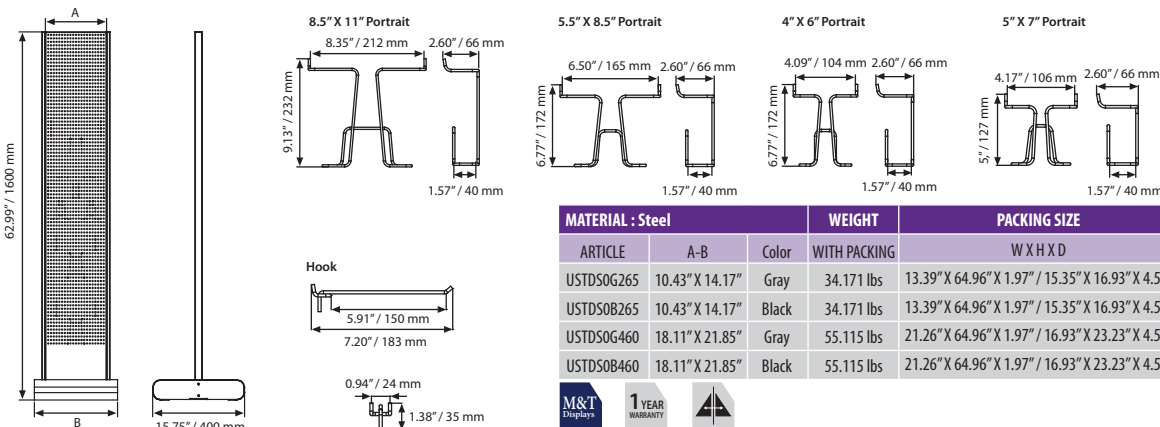

| MATERIAL : Steel | | | WEIGHT | | PACKING SIZE | |
|------------------|-----------------|-------|--------------|---|--------------|--|
| ARTICLE | A-B | Color | WITH PACKING | W X H X D | | |
| USTDSOG265 | 10.43" X 14.17" | Gray | 34.171 lbs | 13.39" X 64.96" X 1.97" / 15.35" X 16.93" X 4.53" | | |
| USTDSOB265 | 10.43" X 14.17" | Black | 34.171 lbs | 13.39" X 64.96" X 1.97" / 15.35" X 16.93" X 4.53" | | |
| USTDSOG460 | 18.11" X 21.85" | Gray | 55.115 lbs | 21.26" X 64.96" X 1.97" / 16.93" X 23.23" X 4.53" | | |
| USTDSOB460 | 18.11" X 21.85" | Black | 55.115 lbs | 21.26" X 64.96" X 1.97" / 16.93" X 23.23" X 4.53" | | |

| SHELF : Steel | | |
|---------------|-------------|-------|
| ARTICLE | SIZE | Color |
| UYPTSOG00A4 | 8.5" X 11" | Gray |
| UYPTSB00A4 | 8.5" X 11" | Black |
| UYPTSG00A5 | 5.5" X 8.5" | Gray |
| UYPTSB00A5 | 5.5" X 8.5" | Black |
| UYPTSG00A6 | 5" X 7" | Gray |
| UYPTSB00A6 | 5" X 7" | Black |
| UYPTSG0A43 | 4" X 6" | Gray |
| UYPTSB0A43 | 4" X 6" | Black |
| UYPTSG0015 | 5.91" | Gray |
| UYPTSB0015 | 5.91" | Black |

* W:Width H: Height D: Depth



Basic Reversible Tower Brochure Stand

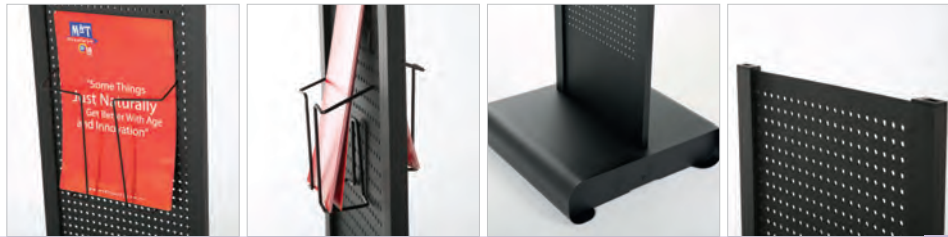

Double Sided Brochure Stand is suitable for indoor environment. One straight module provides double side option. Only difference from Double sided Tower Stand is that; when a brochure holder is used on one side, it is not possible to hang another one on the opposite side to same holes. Holes on the stand allows personalization of brochure placement and size according to needs. 8.5"x11", 5.5"x8.5", 5"x7", 4"x6", 5.91" brochure holders are available. Quite stable with both its heavy base and design. Smooth lower part of brochure stand allows for branding. Ideal for use at reception areas, educational institutions, travel agencies, hotels, offices, marketing events.

- Product is packed unassembled with an easy to understand instruction sheet for assembly.
- Make your own stand design with desired variation of brochure holder placement and size.
- Brochure holders should be ordered separately.
- 2 packs. See info chart for pack sizes.

Color options



RAL powder coated



Magnetic Pet Pocket
Please don't forget to order

| PET POCKET | | |
|------------|-------------|--------|
| PET POCKET | SIZE | COLOUR |
| UPCMOR00A4 | 8.5" X 11" | Red |
| UPCMOB00A4 | 8.5" X 11" | Black |
| UPCMOW00A4 | 8.5" X 11" | White |
| UPCMOG00A4 | 8.5" X 11" | Grey |
| UPCMOG00A5 | 5.5" X 8.5" | Grey |
| UPCMOB00A5 | 5.5" X 8.5" | Black |

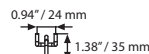
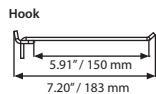
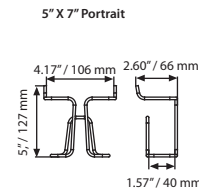
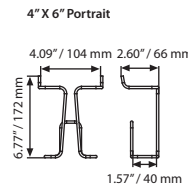
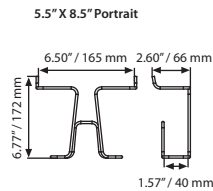
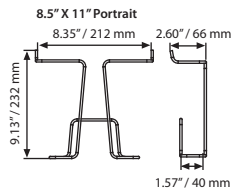
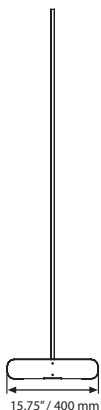
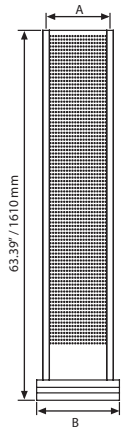

| MATERIAL : Steel | | | WEIGHT | | PACKING SIZE | |
|------------------|-----------------|-------|--------------|---|--------------|--|
| ARTICLE | A-B | Color | WITH PACKING | W X H X D | | |
| USTBSOG265 | 10.43" X 14.17" | Gray | 28.660 lbs | 13.39" X 64.96" X 1.38" / 15.35" X 16.93" X 4.53" | | |
| USTBSOB265 | 10.43" X 14.17" | Black | 28.660 lbs | 13.39" X 64.96" X 1.38" / 15.35" X 16.93" X 4.53" | | |

| SHELF : Steel | | |
|---------------|-------------|-------|
| ARTICLE | SIZE | Color |
| UYPTS00A4 | 8.5" X 11" | Gray |
| UYPTS00A4 | 8.5" X 11" | Black |
| UYPTS00A5 | 5.5" X 8.5" | Gray |
| UYPTS00A5 | 5.5" X 8.5" | Black |
| UYPTS00A6 | 5" X 7" | Gray |
| UYPTS00A6 | 5" X 7" | Black |
| UYPTS0A43 | 4" X 6" | Gray |
| UYPTS0A43 | 4" X 6" | Black |
| UYPTS0015 | 5.91" | Gray |
| UYPTS0015 | 5.91" | Black |

* W:Width H: Height D: Depth

Reversible Tower Brochure Stand for Wall



This Single Sided Brochure Stand is suitable for indoor use. One straight module that is hanged on wall provides stable and noticeable brochure placement. Holes on the stand allows personalization of brochure placement and size according to needs. 8.5"x11", 5.5"x8.5", 5"x7", 4"x6", 5.91" brochure holders are available. Ideal for use at reception areas, educational institutions, travel agencies, hotels, offices, marketing events.

Product is packed unassembled with an easy to understand instruction sheet for assembly.

Make your own stand design with desired variation of brochure holder placement and size.

Brochure holders should be ordered separately.

Color options



Silver Black



RAL powder coated

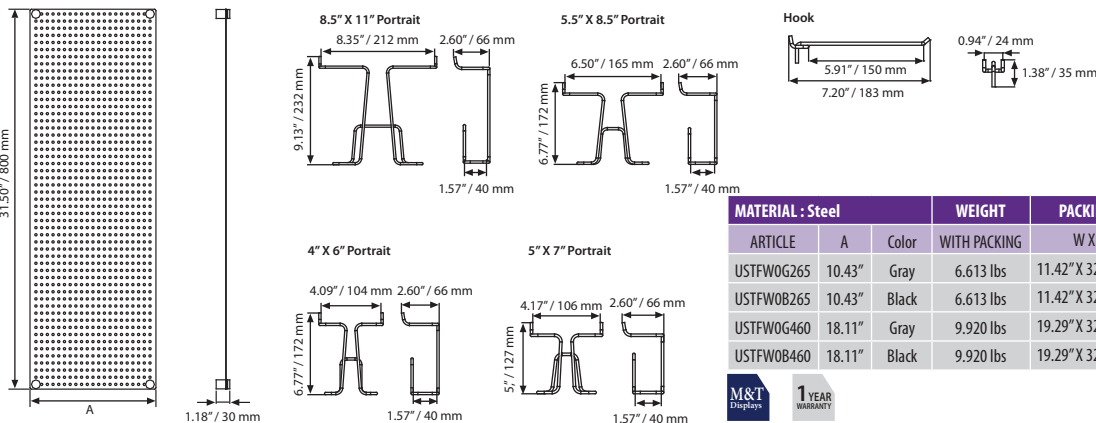

| MATERIAL : Steel | | WEIGHT | | PACKING SIZE | |
|------------------|--------|--------|--------------|-------------------------|--|
| ARTICLE | A | Color | WITH PACKING | W X H X D | |
| USTFWOG265 | 10.43" | Gray | 6.613 lbs | 11.42" X 32.68" X 1.57" | |
| USTFWOB265 | 10.43" | Black | 6.613 lbs | 11.42" X 32.68" X 1.57" | |
| USTFWOG460 | 18.11" | Gray | 9.920 lbs | 19.29" X 32.68" X 1.57" | |
| USTFWOB460 | 18.11" | Black | 9.920 lbs | 19.29" X 32.68" X 1.57" | |

| SHELF : Steel | | |
|---------------|-------------|-------|
| ARTICLE | SIZE | Color |
| UYPTSG00A4 | 8.5" X 11" | Gray |
| UYPTSB00A4 | 8.5" X 11" | Black |
| UYPTSG00A5 | 5.5" X 8.5" | Gray |
| UYPTSB00A5 | 5.5" X 8.5" | Black |
| UYPTSG00A6 | 5" X 7" | Gray |
| UYPTSB00A6 | 5" X 7" | Black |
| UYPTSG0A43 | 4" X 6" | Gray |
| UYPTSB0A43 | 4" X 6" | Black |
| UYPTSG0015 | 5.91" | Gray |
| UYPTSB0015 | 5.91" | Black |

*W:Width H: Height D: Depth



Reversible Tower Brochure Stand

| ARTICLE | CAPACITY | | | | CAPACITY WEIGHT |
|------------|-------------------|--------------------|----------------|----------------|-----------------|
| | 8.5"x11" (PCS) | 5.5"x8.5" (PCS) | 5"x7" (PCS) | 4"x6" (PCS) | |
| USTDSOB265 | 8 | 10 | 24 | 20 | 40 |
| USTDSOG265 | 8 | 10 | 24 | 20 | 40 |
| USTDSOB460 | 16 | 20 | 36 | 30 | 80 |
| USTDSOG460 | 16 | 20 | 36 | 30 | 80 |
| USTBSOB265 | 8 | 10 | 24 | 20 | 40 |
| USTBSOG265 | 8 | 10 | 24 | 20 | 40 |
| USTBSOB460 | 16 | 20 | 36 | 30 | 80 |
| USTBSOG460 | 16 | 20 | 36 | 30 | 80 |
| USTFWOB265 | 2 | 3 | 8 | 6 | 10 |
| USTFWOG265 | 2 | 3 | 8 | 6 | 10 |
| USTFWOB460 | 4 | 6 | 12 | 9 | 20 |
| USTFWOG265 | 4 | 6 | 12 | 9 | 20 |



8.5"x11" Single sided for 10.43" for 4 pcs
8.5"x11" Single sided for 18.11" for 8 pcs

5.5"x8.5" Single sided for 10.43" for 5 pcs
5.5"x8.5" Single sided for 18.11" for 10 pcs

5"x7" Single sided for 10.43" for 12 pcs
5"x7" Single sided for 18.11" for 18 pcs

4"x6" Single sided for 10.43" for 10 pcs
4"x6" Single sided for 18.11" for 15 pcs

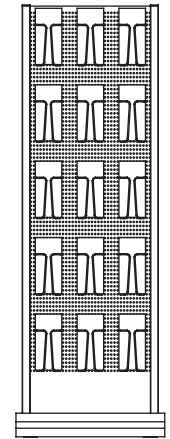
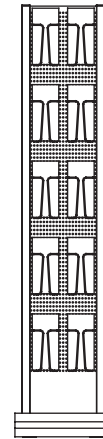
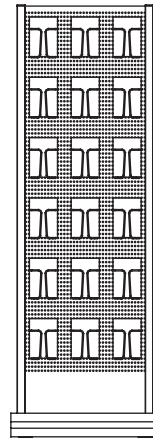
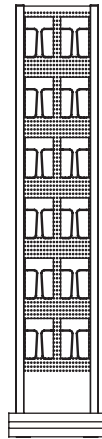
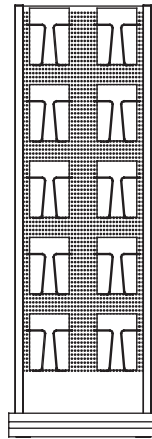
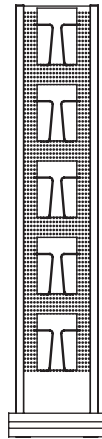
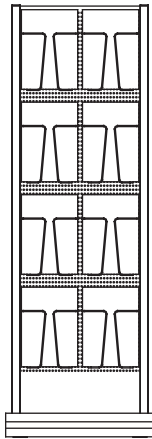
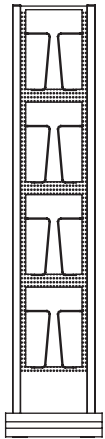

8.5"x11" for wall, 10.43" for 2 pcs
8.5"x11" for wall, 18.11" for 4 pcs

5.5"x8.5" for wall, 10.43" for 3 pcs
5.5"x8.5" for wall, 18.11" for 6 pcs

5"x7" for wall, 10.43" for 8 pcs
5"x7" for wall, 18.11" for 12 pcs

4"x6" for wall, 10.43" for 6 pcs
4"x6" for wall, 18.11" for 9 pcs

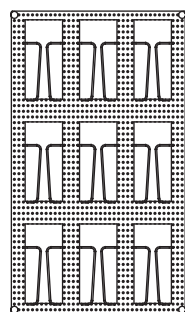
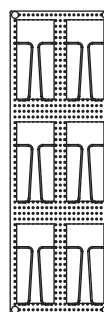
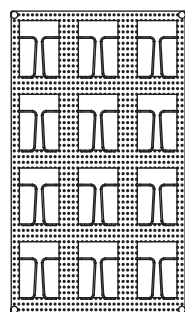
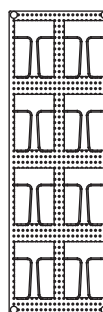
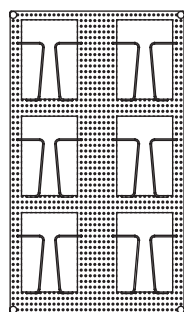
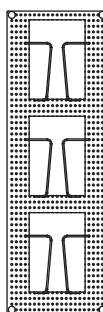
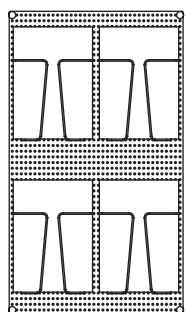
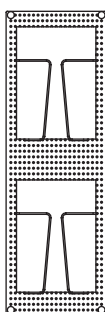

Newage Portable Zick-Zack & Portable Zick-Zacks



Restyled Newage Portable Zick-Zack is a foldable unit that provides 5 shelves of 8.5" X 11" capacity. Newage Portable Zick-Zack shelves allow to fold the unit while the brochures are still stored in. The size of the bag: 14.96" x 18.50" x 11.02". It's a handy and smart product for mobile presentations and events.

- Product is packed assembled, folded in single box.
- No tool assembly, easy to build-up & ready to use.
- Lock the top shelf in position for stable display. Bag is provided optional.

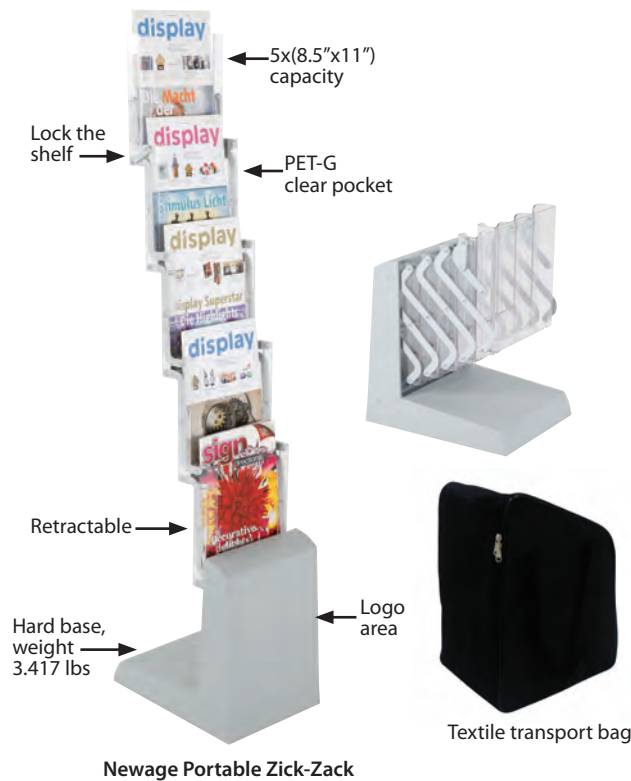

Newage Portable Zick-Zack



Aluminum

Acrylic

Textile transport bag

Newage Portable Zick-Zack

Portable Zick-Zack

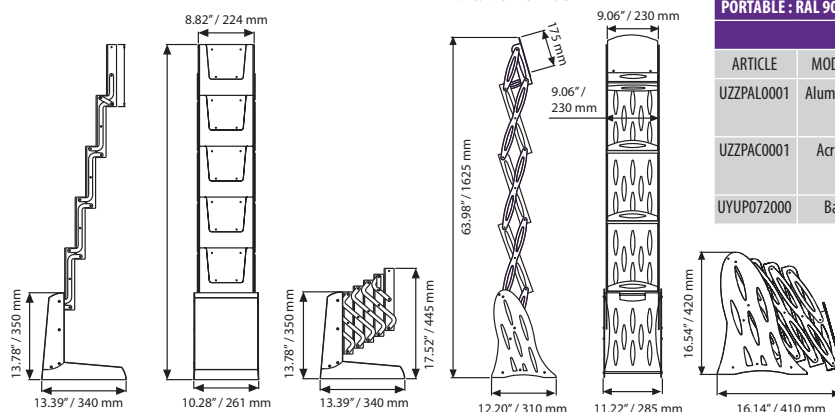

| PORTABLE : RAL 9006 powder coated aluminum & clear | | | SHELF: Aluminum & acrylic options | | | |
|--|----------|------------------|-----------------------------------|---|------------|------------------|
| ARTICLE | MODELS | CAPACITY | WEIGHT WITH PACKING | PACKING SIZE *W X H X D | WITH BAG | WITH BAG&PACKING |
| UZZPAL0001 | Aluminum | 3 X (8.5" X 11") | 12.125 lbs | 18.90" X 18.90" X 11.81" 19.29" X 20.08 X 12.20" | 16.534 lbs | 17.416 lbs |
| UZZPAC0001 | Acrylic | 3 X (8.5" X 11") | 11.023 lbs | 18.90" X 18.90" X 11.81" 19.29" X 20.08 X 12.20" | 15.432 lbs | 16.314 lbs |
| UYUP072000 | Bag | 3 X (8.5" X 11") | 5.291 lbs | 19.29" X 20.08 X 12.20" | 5.291 lbs | |

| NEWAGE : Clear & Grey RAL 9006 | | | WEIGHT | PACKING SIZE |
|--------------------------------|------------------|-------------|--------------|--------------------------|
| ARTICLE | SIZE | DESCRIPTION | WITH PACKING | *W X H X D |
| UZZEPS0181 | 5 X (8.5" X 11") | with bag | 12.125 lbs | 12.20" X 20.47" X 16.14" |

*W:Width H: Height D: Depth

Wood Zick-Zack

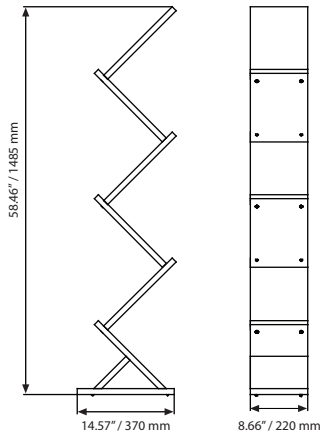
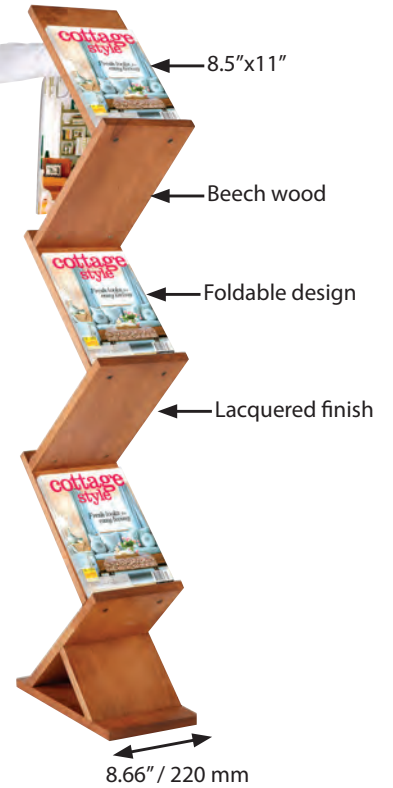
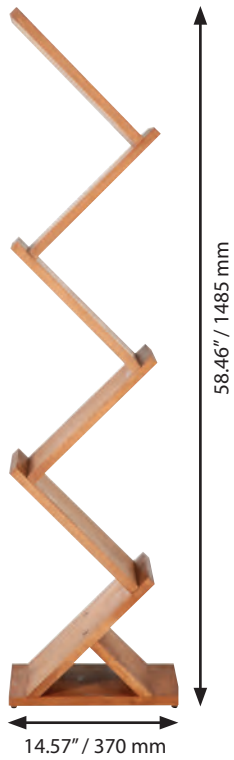

| MATERIAL: Beech wood | | WEIGHT | PACKING SIZE |
|----------------------|------------------|--------------|--------------|
| ARTICLE | SIZE | WITH PACKING | *W X H X D |
| UZZWD005A4 | 5 X (8.5" X 11") | | |

*W:Width H: Height D: Depth

Monoblocks



An elegant & classic clear stand to display an 8.5" X 11" size paper message on top, a pocket for literature in 8.5" X 11" size. Simple to change the message, eye-catching level of height.

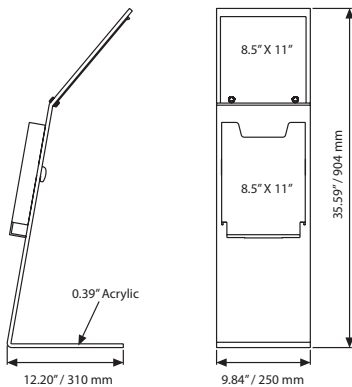

| MATERIAL : Acrylic | | WEIGHT | PACKING SIZE |
|--------------------|------------|--------------|-------------------------|
| ARTICLE | CAPACITY | WITH PACKING | *W X H X D |
| UMNB001000 | 8.5" X 11" | 10.802 lbs | 10.63" X 36.61" X 2.05" |



*W:Width H: Height D: Depth

Literature Racks



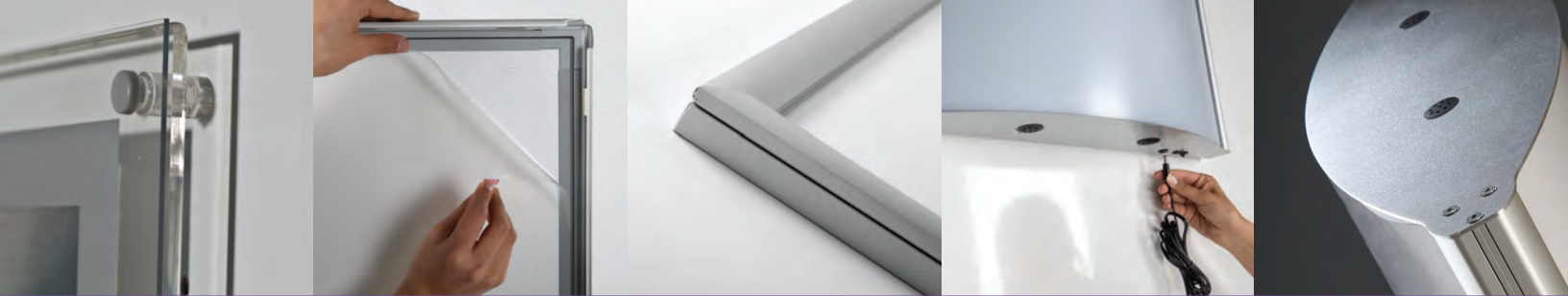

LED Signs

- Convex LEDbox
- Buy Max LEDbox **NEW**
- Best Buy LEDbox
- Smart LEDbox 25 mm
- Smart LEDbox 35 mm
- Lockable Weatherproof Smart LEDbox 35 mm
- Magneco LEDbox
- Acryled for Wall Mounting



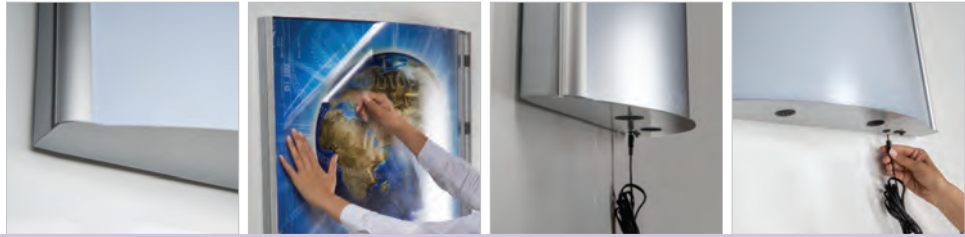

Convex Ledbox



Single faced convex boxes are available in various sizes. Access to posters is by snap frame profiles on each long side. The surface is opal acrylic. The snap has a 1" profile. Convex Lightbox includes a PET cover which is ideal to illuminate your duratrans & posters without shining. Best to be with printings on backlit film or duratrans.

 All units pass CE/UL PAT test and are supplied with their quality certificates. Comes along with 98.43" electrical cable. UK and EU plugs should be mentioned on order.

 Illumination save up to 60% energy cost with an increased life expectancy.

 Product is wall mounting, no further hanging accessories are included in the original pack.

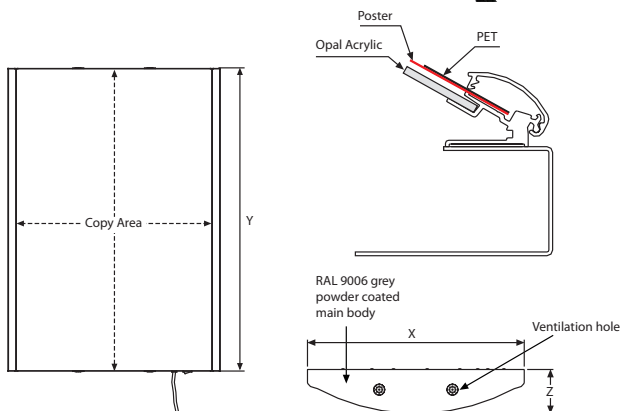

| MATERIAL : Silver anodised aluminium | | | | | WEIGHT | PACKING SIZE |
|--------------------------------------|-----------------|-----------|--------------|---------------|--------------|-------------------------|
| ARTICLE | EXTERNAL (x-y) | POSTER | COPY | LIGHTING | WITH PACKING | *W X H X D |
| UCLB25LN23 | 20.08" X 30.2" | 20" X 30" | 19.06" X 30" | 1800-2200 LUX | 17.592 lbs | 20.67" X 30.71" X 4.33" |
| UCLB25LN22 | 21.93" X 28.15" | 22" X 28" | 20.98" X 28" | 1800-2200 LUX | 16.578 lbs | 24.02" X 28.74" X 4.92" |
| UCLB25LN34 | 29.53" X 40.12" | 30" X 40" | 29.02" X 40" | 2000-2300 LUX | 32.650 lbs | 30.12" X 40.75" X 5.91" |

*W:Width H: Height D: Depth



Buy Max LEDbox Single Sided



See movie at our website www.mtdisplays.com.tr



Ultra slim single sided Buy Max LEDbox with 0.71" thickness is an attractive custom sign solution for a wide range of indoor applications. 1" profile Snap Frame makes the change of poster easy. Even illumination is achieved by specially treated acrylic. Illuminated Buy Max LEDbox will capture the attention of passersby easily wherever it is mounted.

All units pass CE/UL PAT tests and are supplied with their quality certificates. Delivered with 2,5 meter long cable and EU plug. UK and US plugs should be specified with order.

LED illumination saves up to 60% energy costs (compared to fluorescent technology).

Has no switch. Complete with built-in power supply, anti-reflex poster cover and wall plugs.

1 pack. See info chart for pack sizes.

No tool assembly is required.

Color options



Silver Black



- Improved Led technology for improved luminance.
- Pre-treated light guided panel diffuses light even & powerful.
- CE listed electrical components.
- 0.71", thickness lightbox we ever sell.
- Offers evenly diffused lux in all sizes.
- Snap - open frame for easy poster change.
- Saves up to 60% energy costs.



2 wall hangers are standard in each product. Moving hangers let the mounting in portrait and landscape position.



Optional dimmer to go with LED illuminated frame.. Simply jack the dimmer in frame and then into powersupply. It adjust the light from dark to max lux of LED illuminated frame.

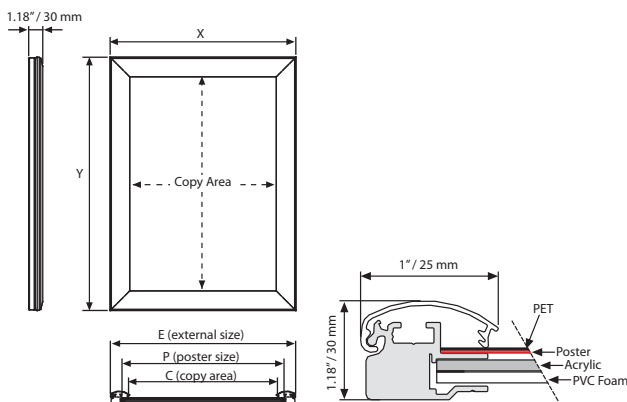

| MATERIAL : Silver anodised aluminium PROFILE: 25 MM | | | | | WEIGHT | PACKING SIZE |
|---|-----------------|-------------|-----------------|---------------|--------------|-------------------------|
| ARTICLE | EXTERNAL (x-y) | POSTER SIZE | COPY | LIGHTING | WITH PACKING | *W X H X D |
| ULM25TN017 | 12.20" X 18.19" | 11" X 17" | 10.20" X 16.18" | | | |
| ULM25TN022 | 23.19" X 29.21" | 22" X 28" | 21.18" X 27.20" | | | |
| ULM25TN023 | 21.18" X 31.18" | 20" X 30" | 19.17" X 29.17" | 1200-1300 LUX | 6.944 lbs | 21.85" X 33.86" X 1.38" |
| ULM25TN024 | 25.20" X 37.20" | 24" X 36" | 23.19" X 35.20" | | | |
| ULM25TN034 | 31.18" X 41.18" | 30" X 40" | 29.17" X 39.17" | 1100-1300 LUX | 14.219 lbs | 31.89" X 43.90" X 1.38" |

*W:Width H:Height D:Depth



Best Buy LEDbox Single Sided



See movie at our website www.mtdisplays.com.tr



Very slim single sided Best Buy LEDbox with 0.71" thickness is an ideal choice for wide range of indoor applications. High illumination is achieved by specially treated acrylic and provides a homogenous illumination. Homogenous and brilliant Best Buy LEDbox will get the attention of consumers easily wherever it is mounted.

- All units pass CE/UL PAT tests and are supplied with their quality certificates. Delivered with 137.80" inch long cable and US plug. UK and EU plugs should be specified with order.
- LED illumination saves up to 60% energy costs (compared to fluorescent technology).
- Has no switch and complete with built-in powersupply, antireflex poster cover and wall hangers.

Color options



0.71" / 18 mm depth



1" / 25 mm snap frame



137.80" / 3,5 m cable



2 wall hangers are standard in each product. Moving hangers let the mounting in portrait and landscape position.



Optional dimmer to go with LED illuminated frame.. Simply jack the dimmer in frame and then into powersupply. It adjust the light from dark to max lux of LED illuminated frame.

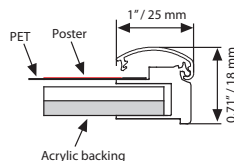
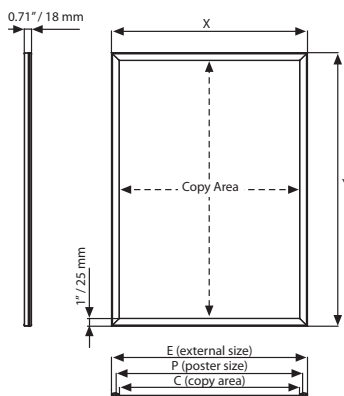

| MATERIAL : Silver anodised aluminium PROFILE: 1" / 25 MM | | | | | WEIGHT | PACKING SIZE |
|--|-----------------|-------------|-----------------|---------------|--------------|-------------------------|
| ARTICLE | EXTERNAL (x-y) | POSTER SIZE | COPY | LIGHTING | WITH PACKING | *W X H X D |
| ULB25TN017 | 12.20" X 18.19" | 11" X 17" | 10.20" X 16.18" | 2800-3000 LUX | 4.034 lbs | 12.80" X 21.06" X 1.38" |
| ULB25TN022 | 23.19" X 29.21" | 22" X 28" | 21.18" X 27.20" | 2000-2200 LUX | 8.179 lbs | 23.82" X 33.27" X 1.38" |
| ULB25TN023 | 21.18" X 31.18" | 20" X 30" | 19.17" X 29.17" | 2200-2500 LUX | 8.399 lbs | 21.85" X 33.86" X 1.38" |
| ULB25TN024 | 25.20" X 37.20" | 24" X 36" | 23.19" X 35.20" | 1900-2100 LUX | 14.374 lbs | 25.79" X 39.96" X 1.38" |
| ULB25TN034 | 31.18" X 41.18" | 30" X 40" | 29.17" X 39.17" | 1700-2000 LUX | 15.807 lbs | 31.89" X 43.90" X 1.38" |

*W:Width H: Height D: Depth



Best Buy LEDbox Double Sided

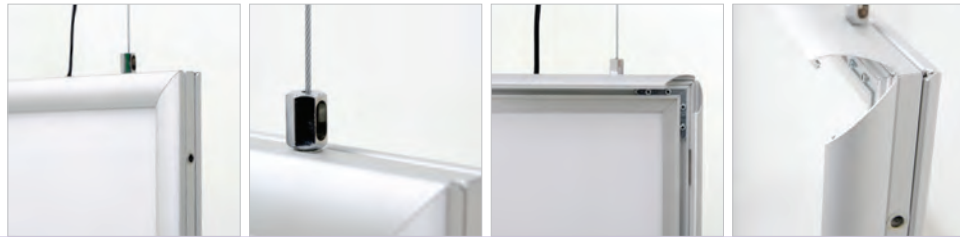

Very slim double sided Best Buy LEDbox with 1.18" thickness is an ideal choice for wide range of indoor applications. High illumination is achieved by specially treated acrylic and provides a homogenous illumination. Homogenous and bright Best Buy LEDbox will get the attention of consumers easily wherever it is mounted.

All units pass CE/UL PAT tests and are supplied with their quality certificates. Delivered with 137.80" long cable and US plug. UK and EU plugs should be specified with order.

LED illumination saves up to 60% energy costs (compared to fluorescent technology).

Complete with 137.80" inch long power supply and suspension kit, but without switch.



Standard hanging kit for all sizes: 78.74" x 2 pcs wire cable and 2 ceiling hangers.



Optional dimmer to go with LED illuminated frame.. Simply jack the dimmer in frame and then into powersupply. It adjust the light from dark to max lux of LED illuminated frame.

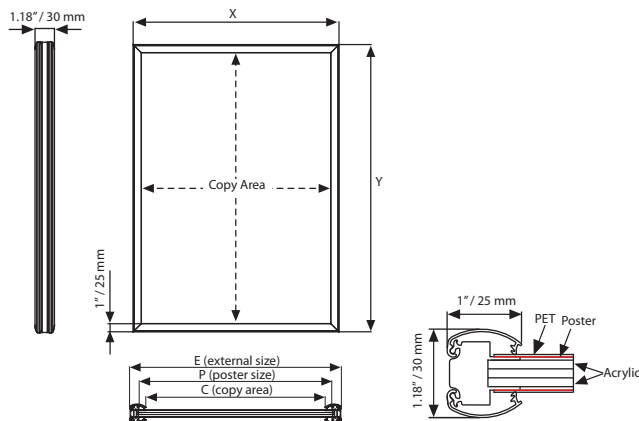

| MATERIAL : Silver anodised aluminium PROFILE: 25 MM | | | | | WEIGHT | PACKING SIZE |
|---|-----------------|-------------|-----------------|---------------|--------------|-------------------------|
| ARTICLE | EXTERNAL (x-y) | POSTER SIZE | COPY | LIGHTING | WITH PACKING | *W X H X D |
| ULB25CN017 | 12.20" X 18.19" | 11" X 17" | 10.20" X 16.18" | 2400-2600 LUX | 5.180 lbs | 12.80" X 21.06" X 1.38" |
| ULB25CN022 | 23.19" X 29.21" | 22" X 28" | 21.18" X 27.20" | 1900-2100 LUX | 12.698 lbs | 23.82" X 33.27" X 1.38" |
| ULB25CN023 | 21.18" X 31.18" | 20" X 30" | 19.17" X 29.17" | 2000-2200 LUX | 12.456 lbs | 21.85" X 33.86" X 1.38" |
| ULB25CN024 | 25.20" X 37.20" | 24" X 36" | 23.19" X 35.20" | 1800-2000 LUX | 18.783 lbs | 25.79" X 39.96" X 1.38" |
| ULB25CN034 | 31.18" X 41.18" | 30" X 40" | 29.17" X 39.17" | 1600-1800 LUX | 24.647 lbs | 31.89" X 43.90" X 1.38" |

*W:Width H:Height D:Depth



Smart Ledbox 1" / 25 mm Single Sided



Very slim single sided Smart LEDbox with 0.75" thickness is an ideal choice for wide range of indoor applications. High illumination is achieved by specially treated acrylic and provides a homogenous illumination. The built-in on/off button and outer power supply help long product life. Homogenous and brilliant Smart LEDbox will get the attention of consumers easily wherever it is mounted.

All units pass CE/UL PAT tests and are supplied with their quality certificates. Delivered with 98.43" long cable and US plug. UK and EU plugs should be specified with order.

LED illumination saves up to 60% energy costs (compared to fluorescent technology).

The lightweight SMART LED BOX with slim profile design and low voltage requirements allow mounting at any given point with access to a regular electrical outlet. The unique frame extrusion offers a wide range of mounting or hanging options.

0.75" / 19 mm depth



- Improved Led technology for improved luminance.
- Pre-treated light guided panel diffuses light even & powerful.
- CE listed electrical components.
- 0.75" thinnest lightbox we ever sell.
- Offers evenly diffused lux in all sizes.
- Snap - open frame for easy poster change.
- Saves up to 60% energy costs.



1" / 25 mm
snap frame



2 wall hangers are standard in each product. Moving hangers let the mounting in portrait and landscape position.

On/off switch button

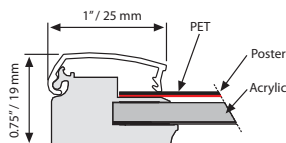
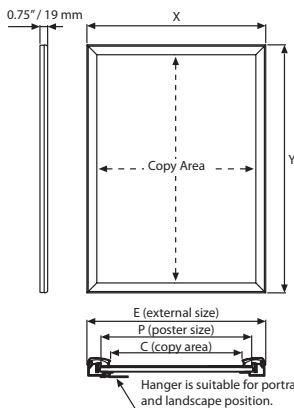

| MATERIAL : Silver anodised aluminium & RAL 9005 powder coated | | | | | | WEIGHT | PACKING SIZE |
|---|------------|-----------------|-----------|-----------------|---------------|--------------|-------------------------|
| SILVER | BLACK | EXTERNAL (x-y) | POSTER | COPY | LIGHTING | WITH PACKING | *W X H X D |
| ULD25TN017 | ULD25TB017 | 12.28" X 18.27" | 11" X 17" | 10.24" X 16.22" | 2200-2500 LUX | 11.265 lbs | 13.19" X 20.87" X 1.81" |
| ULD25TN018 | ULD25TB018 | 19.29" X 25.28" | 18" X 24" | 17.24" X 23.23" | 2300-2500 LUX | 7.936 lbs | 19.88" X 27.95" X 1.81" |
| ULD25TN022 | ULD25TB022 | 23.27" X 29.29" | 22" X 28" | 21.22" X 27.24" | 2400-2700 LUX | 9.920 lbs | 23.62" X 35.43" X 1.81" |
| ULD25TN024 | ULD25TB024 | 25.28" X 37.28" | 24" X 36" | 23.23" X 35.24" | 2500-2900 LUX | 15.652 lbs | 26.18" X 40.16" X 1.81" |
| ULD25TN034 | ULD25TB034 | 31.26" X 41.26" | 30" X 40" | 29.21" X 39.21" | 2300-2800 LUX | 20.392 lbs | 31.89" X 43.90" X 1.81" |

*W:Width H: Height D: Depth



Smart Ledbox 1.38" / 35 mm Single Sided



The specially treated acrylic in the middle provides a homogenous lighting. Single Sided Smart Ledboxes are 1.14" in thickness. The article disposes of a built-in on/off switch. These LED light panels are an ideal choice for a wide range of indoor applications. Max. poster size available is 47.24"x95.08" inch. Improved laser treatment to increase lighting efficiency.

All units pass CE/UL PAT test and comes along with Quality Certificates and with 98.43" electrical cable, UK and EU plugs should be mentioned on order.

LED illumination save up to 60% energy costs (compared to fluorescent technology) with an increased life expectancy.

The SMART LED BOX's lightweight, and low voltage allow it to be mounted anywhere there's access to a regular electrical outlet, and the unique frame extrusion offers a wide range of mounting or hanging options.



1.14" / 29 mm depth



- Improved surface laser treatment for improved luminance
- CE listed electrical components.
- Offers evenly diffused lux in all sizes.
- Saves up to 60% energy costs.



1.38" / 35 mm snap frame



2 wall hangers are standard in each product. Moving hangers let the mounting in portrait and landscape position.

On/off switch button

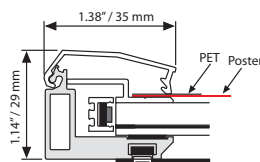
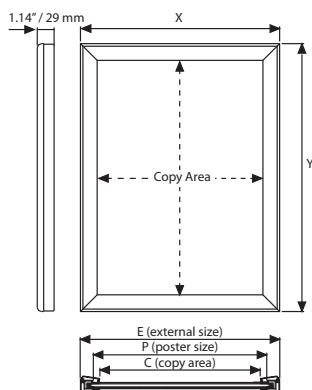

| MATERIAL : Silver anodised aluminium | | | | | WEIGHT | PACKING SIZE |
|--------------------------------------|-----------------|-----------|-----------------|---------------|--------------|-------------------------|
| ARTICLE | EXTERNAL (x-y) | POSTER | COPY | LIGHTING | WITH PACKING | *W X H X D |
| ULD35TN034 | 31.85" X 41.85" | 30" X 40" | 29.09" X 39.09" | 2600-2900 LUX | 30.137 lbs | 34.25" X 48.03" X 2.76" |
| ULD35TN036 | 37.87" X 49.88" | 36" X 48" | 35.12" X 47.13" | 2000-2200 LUX | 37.037 lbs | 40.16" X 55.91" X 2.76" |
| ULD35TN046 | 41.85" X 61.85" | 40" X 60" | 39.09" X 59.09" | 2000-2300 LUX | 58.069 lbs | 44.09" X 68.50" X 2.76" |



*W:Width H: Height D: Depth

Smart Ledbox 1.38" / 35 mm Double Sided



The specially treated acrylic in the middle provides a homogenous lighting. Double Sided Smart Ledboxes are 1.54" in thickness. The article disposes of a built-in on/off switch. These LED light panels are an ideal choice for a wide range of indoor applications. Max. poster size available is 40"x63". Improved laser treatment over acrylic to increase lighting efficiency.

All units pass CE/UL PAT test and comes along with Quality Certificates and with 98.43" electrical cable, UK and EU plugs should be mentioned on order.

LED illumination save up to 60% energy costs (compared to fluorescent technology) with an increased life expectancy.

The SMART LED BOX's low voltage requirements allow it to be mounted anywhere there's access to a regular electrical outlet, and the unique frame extrusion offers a wide range of mounting or hanging options.



1.38" / 35 mm
snap frame

On/off switch button



Standard hanging kit for all sizes: 98.43" x 2 pcs wire cable and 2 ceiling hangers.

- Improved surface laser treatment for improved luminance.
- CE listed electrical components.
- Offers evenly diffused lux in all sizes.
- Saves up to 60% energy costs.

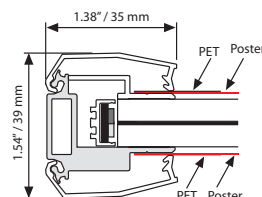
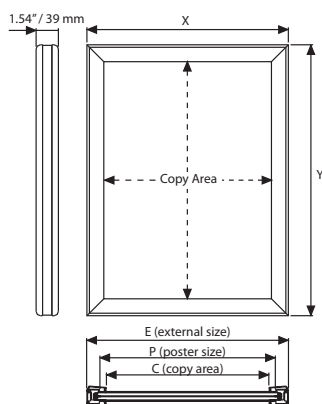

| MATERIAL : Silver anodised aluminium | | | | | WEIGHT | PACKING SIZE |
|--------------------------------------|-----------------|-----------|-----------------|---------------|--------------|-------------------------|
| ARTICLE | EXTERNAL (x-y) | POSTER | COPY | LIGHTING | WITH PACKING | *W X H X D |
| ULD35CN034 | 31.85" X 41.85" | 30" X 40" | 29.09" X 39.09" | 2000-2300 LUX | 33.069 lbs | 35.83" X 46.46" X 2.76" |
| ULD35CN036 | 37.87" X 49.88" | 36" X 48" | 35.12" X 47.13" | 2000-2300 LUX | 41.909 lbs | 40.16" X 55.91" X 2.76" |
| ULD35CN046 | 41.85" X 61.85" | 40" X 60" | 39.09" X 59.09" | 1500-1800 LUX | 63.603 lbs | 46.06" X 66.93" X 2.76" |



*W:Width H: Height D: Depth

Lockable Weatherproof Smart Ledbox 1.38" / 35 mm Single Sided

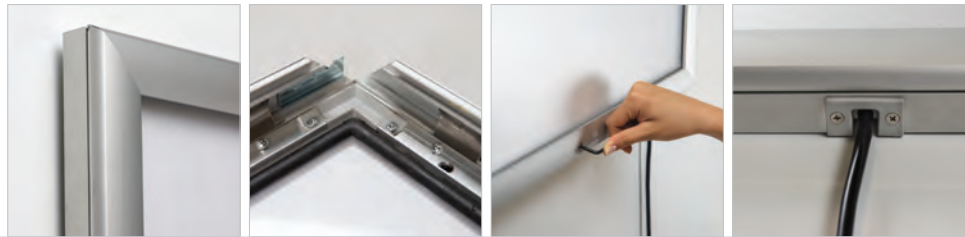

Lockable weatherproof smart ledbox:
Outdoor Smart LEDbox has been improved for using in public places with higher security. Sequentially opening profiles with an allen key keep your poster safe. High and even illumination gets consumer attention to your message.

All units pass CE/UL PAT test and comes along with Quality Certificates and with 98.43" electrical cable, UK and EU plugs should be mentioned on order. Cable length can be extended up to 275.59" by additional cables.

LED illumination save up to 60% energy costs (compared to fluorescent technology) with an increased life expectancy.

The SMART LED BOX'S lightweight, low voltage requirements allow it to be mounted anywhere there's access to a regular electrical outlet, and the unique frame extrusion offers a wide range of mounting or hanging options.

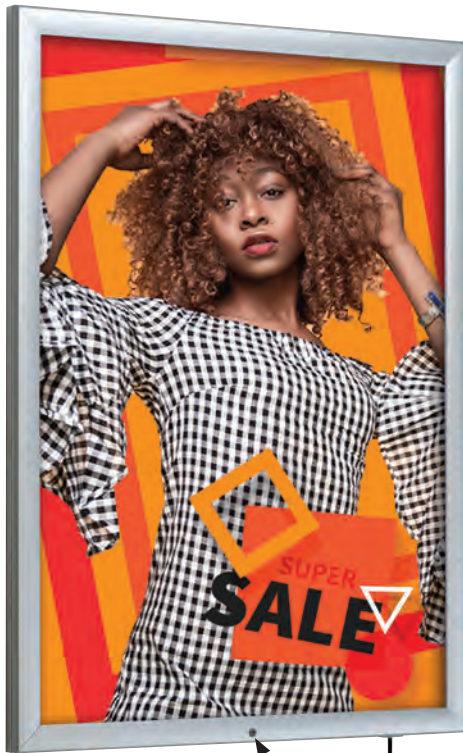

- Improved Led technology and laser treatment.
- IP67 and CE listed electrical Components.
- Offers evenly diffused lux in all sizes.



2 wall hangers are standard in each product. Moving hangers let the mounting in portrait and landscape position.



Mobile cable outlet, from the edge and from the back of the aluminum box.

Weatherproof Power Supply (IP67)

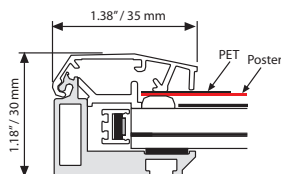
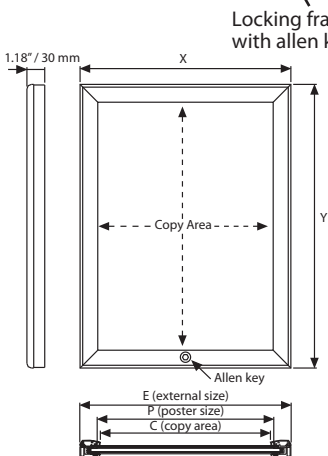
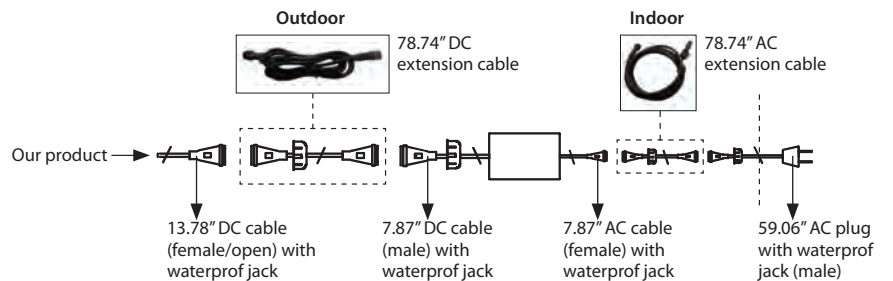

| MATERIAL : Silver anodised aluminium | | | | | WEIGHT | PACKING SIZE |
|--------------------------------------|-----------------|-------------|-----------------|---------------|--------------|-------------------------|
| ARTICLE | EXTERNAL (x-y) | POSTER SIZE | COPY | LIGHTING | WITH PACKING | *W X H X D |
| ULH35TN022 | 24.41" X 30.43" | 22" X 28" | 21.65" X 27.68" | 1600-1900 LUX | 20.943 lbs | 25.98" X 35.83" X 3.15" |
| ULH35TN024 | 26.42" X 38.43" | 24" X 36" | 23.66" X 35.67" | 1400-1700 LUX | 25.353 lbs | 27.95" X 43.90" X 3.15" |
| ULH35TN034 | 32.40" X 42.40" | 30" X 40" | 29.65" X 39.65" | 1400-1700 LUX | 30.886 lbs | 34.25" X 48.43" X 3.15" |
| ULH35TN046 | 42.40" X 62.40" | 40" X 60" | 39.65" X 59.65" | 1000-1200 LUX | 59.238 lbs | 44.09" X 68.90" X 3.15" |



* W:Width H: Height D: Depth

Magneco LedBox Single Sided



See movie at our website www.mtdisplays.com.tr



Very Slim, Magneco LEDbox is a new generation in LEDboxes. With a practical magnetic protection cover, it is very easy to change the poster. High and even illumination level attracts consumers to the message. Hidden finger hole to take off the acrylic cover prevents public access to the poster.

All units pass CE/UL PAT tests and are supplied with their quality certificates. Delivered with 137.80" inch long cable and US plug. UK and EU plugs should be specified with order.

LED illumination saves up to 60% energy costs (compared to fluorescent technology).

Complete with 137.80" inch long power supply, wall hangers and acrylic cover. Without switch.

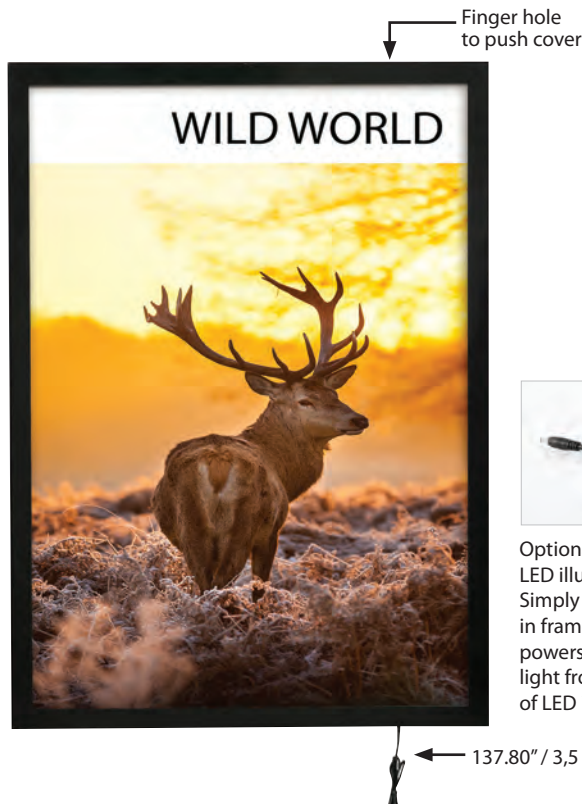

Optional dimmer to go with LED illuminated frame.. Simply jack the dimmer in frame and then into powersupply. It adjust the light from dark to max lux of LED illuminated frame.

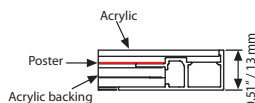
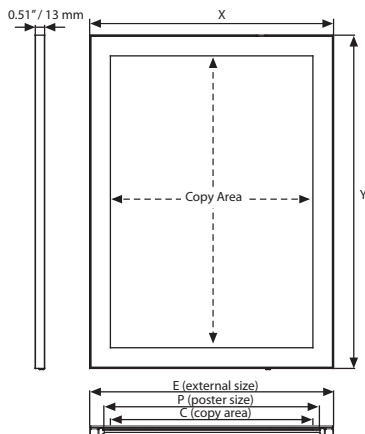

| MATERIAL : Silver & black anodised aluminium | | | | | | WEIGHT | PACKING SIZE |
|--|------------|-----------------|-------------|-----------------|---------------|--------------|-------------------------|
| SILVER | BLACK | EXTERNAL (x-y) | POSTER SIZE | COPY | LIGHTING | WITH PACKING | *W X H X D |
| ULDMENOB17 | ULDMEB0B17 | 12.60" X 18.58" | 11" X 17" | 10.31" X 16.30" | 2800-3000 LUX | 3.769 lbs | 13.39" X 21.26" X 1.38" |
| ULDMENOB22 | ULDMEB0B22 | 23.58" X 29.61" | 22" X 28" | 21.30" X 27.32" | 2000-2200 LUX | 8.620 lbs | 24.41" X 32.28" X 1.38" |
| ULDMENOB23 | ULDMEB0B23 | 21.57" X 31.57" | 20" X 30" | 23.23" X 29.29" | 2200-2500 LUX | 8.686 lbs | 22.24" X 34.25" X 1.38" |
| ULDMENOB24 | ULDMEB0B24 | 25.59" X 37.60" | 24" X 36" | 23.31" X 35.31" | 1900-2100 LUX | 15.873 lbs | 26.38" X 40.35" X 1.38" |
| ULDMENOB34 | ULDMEB0B34 | 31.57" X 41.57" | 30" X 40" | 29.41" X 39.29" | 1800-2100 LUX | 17.350 lbs | 32.28" X 44.29" X 1.38" |

*W:Width H: Height D: Depth



Magneco LEDbox Double Sided



See movie at our website www.mtdisplays.com.tr



Magneco LEDbox: A new generation in LEDboxes. With a practical magnetic protection cover, it is very easy to change the poster. High illumination level attracts consumers to the message. The lightweight Magneco double sided and low voltage requirements allow mounting at any given point with access to a regular electrical outlet.

All units pass CE/UL PAT tests and are supplied with their quality certificates. Delivered with 137.80" inch long cable and US plug. UK and EU plugs should be specified with order.

LED illumination saves up to 60% energy costs (compared to fluorescent technology).

Complete with 137.80" inch long power supply, wall hangers and acrylic cover. Without switch.

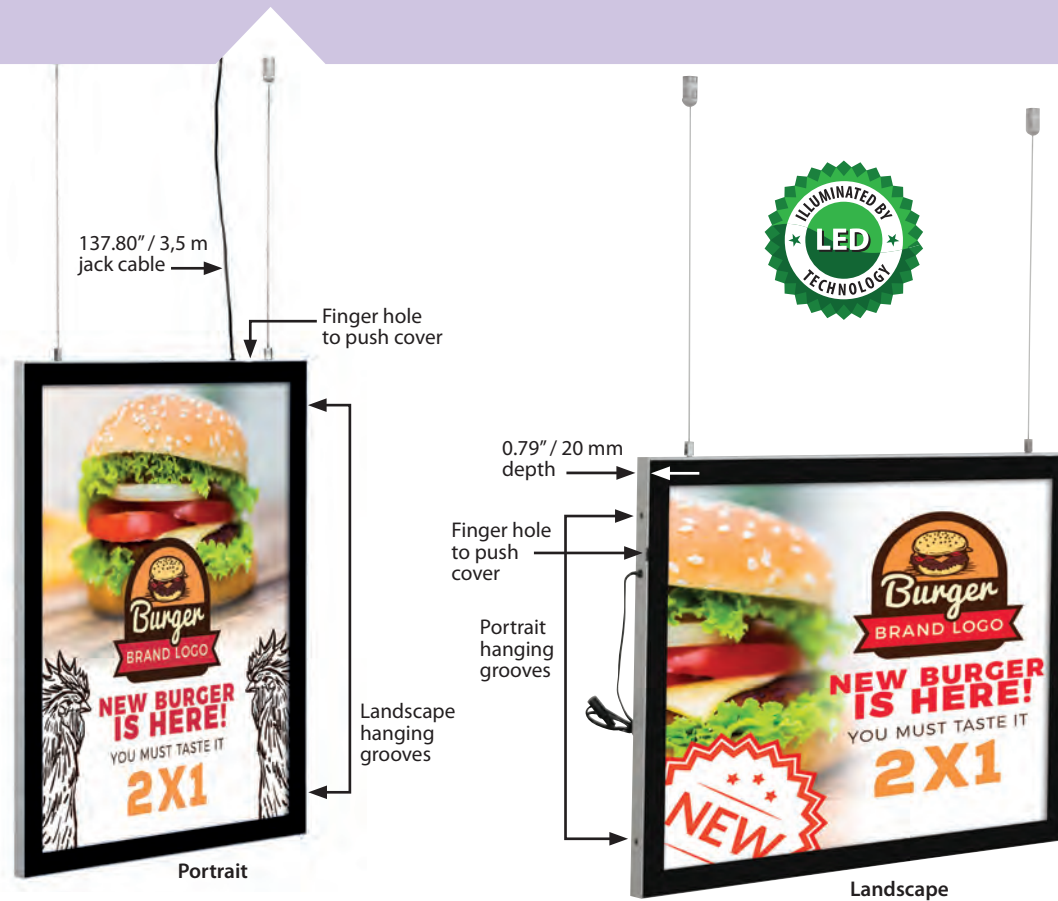

Standard hanging kit for all sizes: 78.74" x 2 pcs wire cable and 2 ceiling hangers.



Optional dimmer to go with LED illuminated frame.. Simply jack the dimmer in frame and then into powersupply. It adjust the light from dark to max lux of LED illuminated frame.

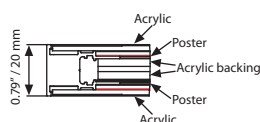
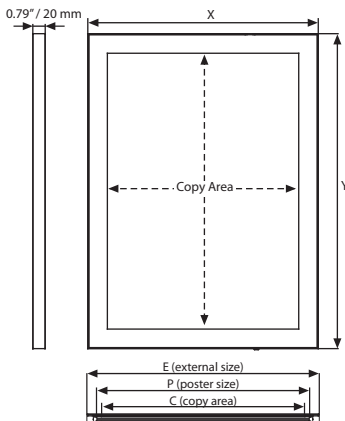

| MATERIAL : Silver & black anodised aluminium | | | | | | WEIGHT | PACKING SIZE |
|--|------------|-----------------|-------------|-----------------|---------------|--------------|-------------------------|
| SILVER | BLACK | EXTERNAL (x-y) | POSTER SIZE | COPY | LIGHTING | WITH PACKING | *W X H X D |
| ULDMENCB17 | ULDMEBCB17 | 12.60" X 18.58" | 11" X 17" | 10.31" X 16.30" | 2400-2600 LUX | 6.459 lbs | 13.39" X 21.26" X 1.38" |
| ULDMENCB22 | ULDMEBCB22 | 23.58" X 29.61" | 22" X 28" | 21.30" X 27.32" | 1900-2100 LUX | 15.278 lbs | 24.41" X 32.28" X 1.38" |
| ULDMENCB23 | ULDMEBCB23 | 21.57" X 31.57" | 20" X 30" | 23.23" X 29.29" | 2000-2200 LUX | 15.101 lbs | 22.24" X 34.25" X 1.38" |
| ULDMENCB24 | ULDMEBCB24 | 25.59" X 37.60" | 24" X 36" | 23.31" X 35.31" | 1800-2000 LUX | 22.068 lbs | 26.38" X 40.35" X 1.38" |
| ULDMENCB34 | ULDMEBCB34 | 31.57" X 41.57" | 30" X 40" | 29.41" X 39.29" | 1600-1800 LUX | 29.982 lbs | 32.28" X 44.29" X 1.38" |

*W:Width H: Height D: Depth



AcryLed for Wall Mounting



See movie at our website www.mtdisplays.com.tr



Ultra slim and clear Acryled. The edge-lit acryled mounts portrait or landscape for various types of signage. Acryled lit with LEDs use less power than traditional with light signage. Poster is placed in between the specially treated acrylic & cover acrylic sheet & fixed in position by two clear clips on two short sides. Products is available in 2 colours; silver and black. Compared to traditional articles in the market, Acryled provides easy poster change when unit keeps mounted on the wall.

All units pass CE/UL PAT test and are supplied with their quality certificates. Comes along with 98.43" electrical cable. UK and EU plugs should be mentioned on order.

Illumination save up to 60% energy cost with an increased life expectancy.

Acryled's lightweight and low voltage requirements allow it to be mounted anywhere there's access to regular electrical outlet.

Color options

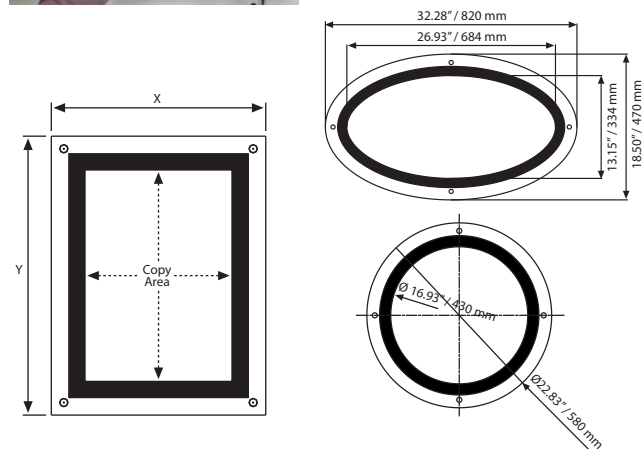

| MATERIAL : Treated illuminated acrylic | | | | | WEIGHT | PACKING SIZE |
|--|-----------------|-----------------|-----------------|---------------------|--------------|-------------------------|
| ARTICLE | EXTERNAL (x-y) | POSTER | COPY | DESCRIPTION | WITH PACKING | *W X H X D |
| UACLON0081 | 12.95" X 15.47" | 8.5" X 11" | 7.87" X 10.39" | Square - Silver | 4.850 lbs | 14.17" X 19.69" X 2.76" |
| UACLON0017 | 15.47" X 21.46" | 11" X 17" | 10.39" X 16.38" | Square - Silver | 7.716 lbs | 17.72" X 24.41" X 2.76" |
| UACLOB0081 | 12.95" X 15.47" | 8.5" X 11" | 7.87" X 10.39" | Square - Black | 4.850 lbs | 14.17" X 19.69" X 2.76" |
| UACLOB0017 | 15.47" X 21.46" | 11" X 17" | 10.39" X 16.38" | Square - Black | 7.716 lbs | 17.72" X 24.41" X 2.76" |
| UACLYN0000 | Ø 22.83" | Ø 17.56" | Ø 16.93" | Circle - Silver | 12.125 lbs | 24.80" X 27.56" X 2.95" |
| UACLYB0000 | Ø 22.83" | Ø 17.56" | Ø 16.93" | Circle - Black | 12.125 lbs | 24.80" X 27.56" X 2.95" |
| UACLEN0000 | 32.28" X 18.50" | 27.56" X 13.78" | 26.93" X 13.15" | Elliptical - Silver | 14.330 lbs | 20.47" X 36.61" X 2.95" |
| UACLEB0000 | 32.28" X 18.50" | 27.56" X 13.78" | 26.93" X 13.15" | Elliptical - Black | 14.330 lbs | 20.47" X 36.61" X 2.95" |

*W:Width H: Height D: Depth



Smart LEDbox LED Product Programme (Production & Availability)

| Size Available | 25mm Indoor LEDbox | | 35mm Indoor LEDbox | | 35mm Outdoor/ Lockable LEDbox | Best Buy LEDbox | | Magneco LEDbox | | Convex LEDbox | AcryLED | Buy Max LEDbox |
|-----------------|--------------------|-----------------|--------------------|------------|-------------------------------|-----------------|-----------------|-----------------|-----------------|-----------------|-----------------|-----------------|
| | single | double | single | double | single | single | double | single | double | single | single | single |
| Poster Size | single | double | single | double | single | single | double | single | double | single | single | single |
| 81 - 8,5" x 11" | X | X | X | X | X | X | X | X | X | X | X | X |
| 17 - 11" x 17" | ULD25TN017 | ULD25CN017 | ULD35TN017 | ULD35CN017 | ULS35TN017 | ULB25TN017 | ULB25CN017 | ULDMENOB17 | ULDMENCB17 | UCLB25LN17 | UACLON0017 | ULM25TN017 |
| 18 - 18" x 24" | ULD25TN018 | ULD25CN018 | X | X | X | X | X | X | X | X | UACLON0018 | ULM25TN018 |
| 22 - 22" x 28" | ULD25TN022 | ULD25CN022 | ULD35TN022 | ULD35CN022 | ULS35TN022 | ULB25TN022 | ULB25CN022 | ULDMENOB22 | ULDMENCB22 | UCLB25LN22 | UACLON0022 | ULM25TN022 |
| 23 - 20" x 30" | ULD25TN023 | ULD25CN023 | ULD35TN023 | ULD35CN023 | ULS35TN023 | ULB25TN023 | ULB25CN023 | ULDMENOB23 | ULDMENCB23 | UCLB25LN23 | UACLON0023 | ULM25TN023 |
| 24 - 24" x 36" | ULD25TN024 | X | ULD35TN024 | ULD35CN024 | ULS35TN024 | ULB25TN024 | ULB25CN024 | ULDMENOB24 | ULDMENCB24 | X | UACLON0024 | ULM25TN024 |
| 34 - 30" x 40" | ULD25TN034 | X | ULD35TN034 | ULD35CN034 | ULS35TN034 | ULB25TN034 | ULB25CN034 | ULDMENOB34 | ULDMENCB34 | UCLB25LN34 | UACLON0034 | ULM25TN034 |
| 36 - 36" x 48" | X | X | X | X | X | X | X | X | X | X | X | X |
| 46 - 40" x 60" | X | X | ULD35TN046 | ULD35CN046 | ULS35TN046 | X | X | X | X | X | X | X |
| Max(w x h) inch | 33.46" x 47.24" | 23.62" x 35.43" | 47.24" x 95" | 40" x 63" | 47.24" x 82.67" | 33.46" x 78.74" | 33.46" x 78.74" | 33.46" x 47.24" | 33.46" x 47.24" | 33.46" x 49.21" | 33.46" x 47.24" | 27.56" x 39.37" |

*Max perimeter is 157.48" in condition of short profile is max 33.46" and long profile is max 59.06".

| Power Consumption | 25mm Indoor LEDbox | | 35mm Indoor LEDbox | | 35mm Outdoor/ Lockable LEDbox | Best Buy LEDbox | | Magneco LEDbox | | Convex LEDbox | AcryLED | Buy Max LEDbox |
|-------------------|--------------------|-------------|--------------------|-------------|-------------------------------|-----------------|---------------|----------------|---------------|---------------|-------------|----------------|
| | single | double | single | double | single | single | double | single | double | single | single | single |
| Poster Size | single | double | single | double | single | single | double | single | double | single | single | single |
| 81 - 8,5" x 11" | X | X | X | X | X | X | X | X | X | X | X | X |
| 17 - 11" x 17" | 18W / 1,44A | 18W / 1,5A | 18W / 1,44A | 26W / 2,16A | 18W / 1,44A | 10W / 0,84A | 16,6W / 1,22A | 10W / 0,84A | 16,6W / 1,22A | 6,4W / 0,53A | 18W / 1,44A | 18W / 1,44A |
| 18 - 18" x 24" | 20W / 1,6A | 23W / 1,92 | X | X | X | X | X | X | X | X | 27W / 2,24A | 27W / 2,24A |
| 22 - 22" x 28" | 27W / 2,24A | 28W / 2,33A | 27W / 2,24A | 41W / 3,33A | 27W / 2,24A | 17,6W / 1,5A | 24W / 2A | 17,6W / 1,5A | 24W / 2A | 13,2W / 1,1A | 31W / 2,56A | 31W / 2,56A |
| 23 - 20" x 30" | 31W / 2,56A | 32W / 2,66A | 31W / 2,56A | 46W / 3,83A | 31W / 2,56A | 17W / 1,41A | 26W / 2,16A | 17W / 1,41A | 26W / 2,16A | 19,3W / 1,6A | 41W / 3,33A | 41W / 3,33A |
| 24 - 24" x 36" | 38W / 3,16A | X | 41W / 3,33A | 61W / 5A | 41W / 3,33A | 22,5W / 1,9A | 31W / 2,6A | 22,5W / 1,9A | 31W / 2,6A | 30W / 2,6A | 41W / 3,36A | 41W / 3,36A |
| 34 - 30" x 40" | 41W / 3,36A | X | 41W / 3,36A | 62W / 5A | 41W / 3,36A | 25W / 2,08A | 36W / 3,02A | 25W / 2,08A | 36W / 3,02A | 26,5W / 2,2A | 41W / 3,36A | 41W / 3,36A |
| 36 - 36" x 48" | X | X | X | X | X | X | X | X | X | X | X | X |
| 46 - 40" x 60" | X | X | 60W / 5A | 94W / 7,5A | 60W / 5A | X | X | X | X | X | X | X |

| Power Supply Recommended (12 Vdc, Ampere) | 25mm Indoor LEDbox | | 35mm Indoor LEDbox | | 35mm Outdoor/ Lockable LEDbox | Best Buy LEDbox | | Magneco LEDbox | | Convex LEDbox | AcryLED | Buy Max LEDbox |
|---|--------------------|--------|--------------------|--------|-------------------------------|-----------------|--------|----------------|--------|---------------|---------|----------------|
| | single | double | single | double | single | single | double | single | double | single | single | single |
| Poster Size | single | double | single | double | single | single | double | single | double | single | single | single |
| 81 - 8,5" x 11" | X | X | X | X | X | X | X | X | X | X | X | X |
| 17 - 11" x 17" | 2A | 2A | 2A | 3A | 2A | 2A | 2A | 2A | 2A | 1A | 2A | 2A |
| 18 - 18" x 24" | 2A | 3A | X | X | X | X | X | X | X | X | 3A | 3A |
| 22 - 22" x 28" | 3A | 3A | 3A | 4A | 3A | 2A | 3A | 2A | 3A | 2A | 3A | 3A |
| 23 - 20" x 30" | 3A | 3A | 3A | 5A | 3A | 2A | 3A | 2A | 3A | 2A | 4A | 4A |
| 24 - 24" x 36" | 4A | X | 4A | 6A | 4A | 3A | 3A | 3A | 3A | 3A | 4A | 4A |
| 34 - 30" x 40" | 4A | X | 4A | 6A | 4A | 3A | 4A | 3A | 4A | 3A | 4A | 4A |
| 36 - 36" x 48" | X | X | X | X | X | X | X | X | X | X | X | X |
| 46 - 40" x 60" | X | X | 6A | 9A | 6A | X | X | X | X | X | X | X |

| LUX | 25mm Indoor LEDbox | | 35mm Indoor LEDbox | | 35mm Outdoor/ Lockable LEDbox | Best Buy LEDbox | | Magneco LEDbox | | Convex LEDbox | AcryLED | Buy Max LEDbox |
|-----------------|--------------------|-----------|--------------------|-----------|-------------------------------|-----------------|-----------|----------------|-----------|---------------|-----------|----------------|
| | single | double | single | double | single | single | double | single | double | single | single | single |
| Poster Size | single | double | single | double | single | single | double | single | double | single | single | single |
| 81 - 8,5" x 11" | X | X | X | X | X | X | X | X | X | X | X | X |
| 17 - 11" x 17" | 1700-1200 | 1500-1800 | 3900-4200 | 2200-2500 | 2700-3000 | 2800-3000 | 2400-2600 | 2800-3000 | 2400-2600 | 2800-3300 | 2400-2600 | 2400-2600 |
| 18 - 18" x 24" | 2500-2800 | 1800-2100 | X | X | X | X | X | X | X | X | 2200-2400 | 2200-2400 |
| 22 - 22" x 28" | 3300-3600 | 2000-2300 | 3000-3300 | 2300-2700 | 1800-2100 | 2000-2200 | 1900-2100 | 2000-2200 | 1900-2100 | 2500-3000 | 2100-2300 | 2100-2300 |
| 23 - 20" x 30" | 2900-3200 | 1700-1900 | 3000-3300 | 2100-2400 | 1600-1900 | 2200-2500 | 2000-2200 | 2200-2500 | 2000-2200 | 1800-2200 | 2000-2200 | 2000-2200 |
| 24 - 24" x 36" | 3000-3300 | X | 2000-2300 | 2100-2400 | 1600-1900 | 1900-2100 | 1800-2000 | 1900-2100 | 1800-2000 | 2000-2300 | 1800-2200 | 1800-2200 |
| 34 - 30" x 40" | 2500-2800 | X | 2600-2900 | 2000-2300 | 1400-1700 | 1700-2000 | 1600-1800 | 1800-2100 | 1600-1800 | 2000-2300 | 2100-2600 | 2100-2600 |
| 36 - 36" x 48" | X | X | X | X | X | X | X | X | X | X | X | X |
| 46 - 40" x 60" | X | X | 2000-2300 | 1500-1800 | 1000-2000 | X | X | X | X | X | X | X |

- ✓ Standard colour: Silver Anodised
- ✓ Available in RAL colours (subject to MOQ)
- ✓ Power supply is provided with the unit to suit each of the product
- ✓ Luminance: 2000-3000 lux (depending on size)
- ✓ Standard Packaging: Single units in polybag and box
- ✓ Low power consumption (see above average power consumption table for each size)
- ✓ Various plugs available such as European, UK, US and Australian
- ✓ Complies with EN55015 & EN61547.

| POWER SUPPLY | |
|--------------|----------------------------|
| ARTICLE | DESCRIPTION |
| UYPLD00010 | Power supply EU 3,34A 7/24 |
| UYPLD00011 | Power supply EU 6,67A 7/24 |
| UYPLD00012 | Power supply EU 8,5A 7/24 |
| UYPLD00013 | Power supply EU 11,5A 7/24 |

- ✓ Products are suitable to use 7/16.
- ✓ If 7/24 use required, please order individually as 7/24 power supplies as below:



In case of any claim, user is required to return product or any parts to manufacturer for analyses at their cost. As long as the manufacturer confirms the problem is a manufacturing fault, the replacement can be provided. This applies for all illuminated products.

LED Signs





Message Boards

- Frameboards
- Enclosed Bulletin Boards
 - Office Boards
 - Universal Showboard Cork
 - Showboards
- Premium Grade Enclosed Bulletin Boards
 - Noticeboards
 - Noticeboards With Led Light
 - Noticeboards With Logo



Office Boards



Suitable for indoor use. It has 2 different backing models. Each unit includes a free set of pins or magnets. Single key 4x(8.5"x11"), double key 6x(8.5"x11"), 9x(8.5"x11") and 12x(8.5"x11") sizes are available and can be used both in portrait & landscape positions. The cover can be opened to 90 degrees. Each unit includes mounting screw and plugs for easy wall mounting. The depth of the case is 1.38".

Each product includes 1 key set of singlevariation.

! Please discard the protective film on the unit before use.



Cork



Magnetic

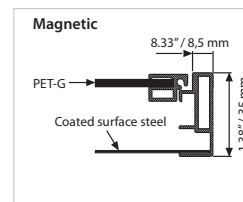
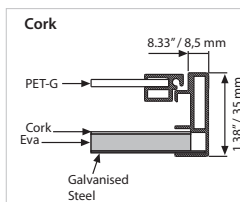
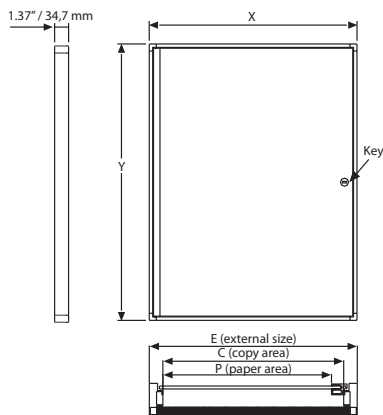

| MATERIAL : Silver anodised aluminium | | | | | | | WEIGHT WITH PACKING | | PACKING SIZE |
|--------------------------------------|------------|-----------------|-----------------|-----------------|------------------|-----|---------------------|------------|-------------------------|
| CORK | MAGNETIC | EXTERNAL (x-y) | COPY | PAPER AREA | CAPACITY | KEY | MAGNETIC | CORK | *W X H X D |
| USBN4004A4 | USBN5004A4 | 20.28" X 26.97" | 18.66" X 25.87" | 19.17" X 25.87" | 4 X (8.5" X 11") | 2 | 9.964 lbs | 9.479 lbs | 21.46" X 28.15" X 2.36" |
| USBN4006A4 | USBN5006A4 | 20.28" X 39.57" | 18.66" X 38.46" | 19.17" X 38.46" | 6 X (8.5" X 11") | 2 | 15.319 lbs | 15.167 lbs | 21.46" X 40.75" X 2.36" |
| USBN4009A4 | USBN5009A4 | 29.33" X 39.57" | 27.72" X 38.46" | 28.23" X 38.46" | 9 X (8.5" X 11") | 2 | 19.114 lbs | 20.348 lbs | 30.31" X 40.75" X 2.36" |



* W:Width H: Height D: Depth

Universal Showboard with Cork & Magnetic

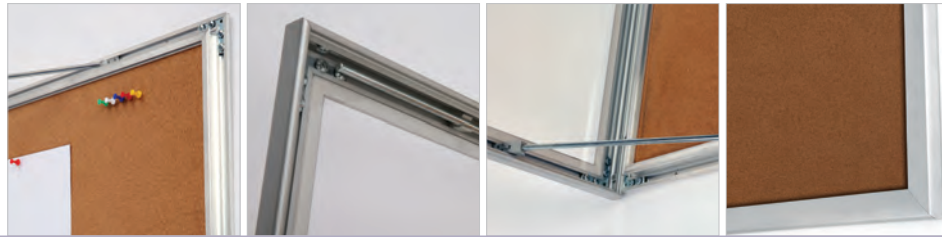

Universal Showboard has 2 models; one with a cork backing and with a magnetic backing. It has a slim case which is 1.06" deep and 1.18" profile and hidden lock on the side. It is suitable for public places or outdoor use under a shelter.

- Each product includes 1 key set of single variation.
- Each unit is supplied with a free set of clear plastic pegs to hold the poster. 2 stays at each end help to keep the cover door open.
- Please discard the protective film on the unit before use.

1.06" / 27 mm thickness



Magnetic



Cork

Discreet door lock

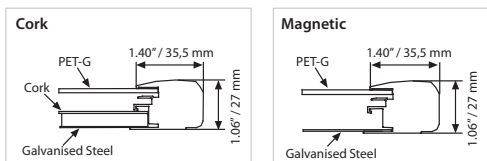

Size of boards for all Universal Showboard models:

| | 6x(8.5"x11") | | 9x(8.5"x11") | |
|--------------|--------------|------------|--------------|------------|
| 4x(8.5"x11") | (8.5"x11") | (8.5"x11") | (8.5"x11") | (8.5"x11") |
| | (8.5"x11") | (8.5"x11") | (8.5"x11") | (8.5"x11") |
| | (8.5"x11") | (8.5"x11") | (8.5"x11") | (8.5"x11") |
| | (8.5"x11") | (8.5"x11") | (8.5"x11") | (8.5"x11") |

| MATERIAL : Silver anodised aluminium | | | | | | | WEIGHT | PACKING SIZE |
|--------------------------------------|------------|-----------------|-----------------|-----------------|------------------|-----|--------------|-------------------------|
| CORK | MAGNETIC | EXTERNAL (x-y) | COPY | PAPER AREA | CAPACITY | KEY | WITH PACKING | *W X H X D |
| USBNU104A4 | USBNU204A4 | 22.05" X 28.74" | 19.25" X 25.94" | 19.13" X 25.83" | 4 X (8.5" X 11") | 1 | 14.330 lbs | 22.83" X 30.31" X 1.81" |
| USBNU106A4 | USBNU206A4 | 22.05" X 41.34" | 19.25" X 38.54" | 19.13" X 38.43" | 6 X (8.5" X 11") | 2 | 18.518 lbs | 22.83" X 42.91" X 1.81" |
| USBNU109A4 | USBNU209A4 | 31.10" X 41.34" | 28.31" X 38.54" | 28.19" X 38.43" | 9 X (8.5" X 11") | 2 | 24.691 lbs | 31.89" X 42.91" X 1.81" |



*W:Width H: Height D: Depth

Showboards

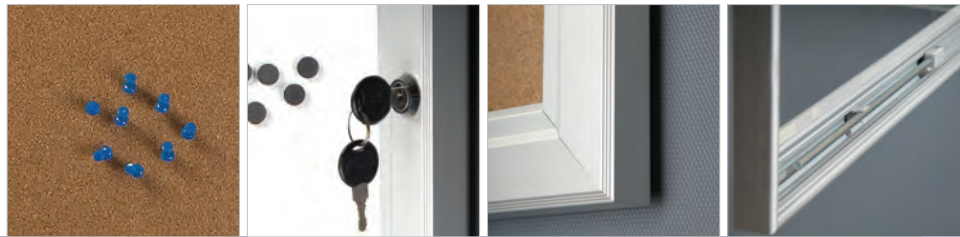

Suitable for outdoor use. It has 3 model; with a cork backing, with a magnetic backing, with a cork and perforated steel backing. Single key 4x(8.5"x11"), double key 6x(8.5"x11"), 9x(8.5"x11") and 12x(8.5"x11") sizes are available and can be used both in portrait & landscape positions. The cover can be opened to 90 degrees. Each unit includes mounting screw and plugs for easy wall mounting and a free set of pins&magnets. The profile width is 1.77" and the depth of the case 1.42".

Each product includes 1 key set of single variation.

Each unit includes a free of pins. 2 stays at each end help to keep the cover door open.

Please discard the protective film on the unit before use. Please throw away the silicagel on the cork before use.

Size of boards for all Showboard models:

| | 4x(8.5"x11") | | 6x(8.5"x11") | | 9x(8.5"x11") | | 12x(8.5"x11") | |
|------------|--------------|------------|--------------|------------|--------------|------------|---------------|------------|
| (8.5"x11") | (8.5"x11") | (8.5"x11") | (8.5"x11") | (8.5"x11") | (8.5"x11") | (8.5"x11") | (8.5"x11") | (8.5"x11") |
| (8.5"x11") | (8.5"x11") | (8.5"x11") | (8.5"x11") | (8.5"x11") | (8.5"x11") | (8.5"x11") | (8.5"x11") | (8.5"x11") |
| (8.5"x11") | (8.5"x11") | (8.5"x11") | (8.5"x11") | (8.5"x11") | (8.5"x11") | (8.5"x11") | (8.5"x11") | (8.5"x11") |
| (8.5"x11") | (8.5"x11") | (8.5"x11") | (8.5"x11") | (8.5"x11") | (8.5"x11") | (8.5"x11") | (8.5"x11") | (8.5"x11") |



Magnetic



Cork

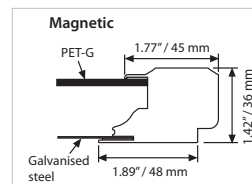
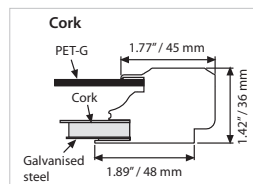
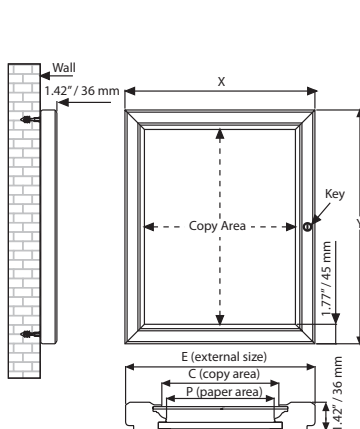

| MATERIAL : Silver anodised aluminium | | | | | | | WEIGHT WITH PACKING | | | PACKING SIZE | |
|--------------------------------------|------------|-----------------|-----------------|-----------------|-------------------|-----|---------------------|------------|------------|-------------------------|--|
| CORK | MAGNETIC | EXTERNAL (x-y) | COPY | PAPER AREA | CAPACITY | KEY | CORK | MAGNETIC | M&C | *W X H X D | |
| USBN1004A4 | USBN2004A4 | 23.03" X 29.72" | 19.49" X 26.18" | 19.02" X 25.71" | 4 X (8.5" X 11") | 1 | 15.145 lbs | 13.227 lbs | 18.188 lbs | 24.41" X 30.71" X 2.36" | |
| USBN1006A4 | USBN2006A4 | 23.03" X 42.32" | 19.49" X 38.78" | 19.02" X 38.31" | 6 X (8.5" X 11") | 2 | 19.731 lbs | 18.408 lbs | 24.250 lbs | 24.41" X 43.31" X 2.36" | |
| USBN1009A4 | USBN2009A4 | 32.09" X 42.32" | 28.54" X 38.78" | 28.07" X 38.31" | 9 X (8.5" X 11") | 2 | 27.557 lbs | 25.573 lbs | 33.289 lbs | 33.46" X 43.31" X 2.36" | |
| USBN1012A4 | USBN2012A4 | 41.14" X 42.32" | 37.60" X 38.78" | 37.13" X 38.31" | 12 X (8.5" X 11") | 2 | 33.951 lbs | 31.327 lbs | 41.887 lbs | 42.52" X 43.31" X 2.36" | |



*W:Width H: Height D: Depth

Felt Showboard



Suitable for outdoor use. It has a felt backing that welcomes both Velcro and pins. Each unit includes a free set of pins. Single key 4x(8.5"x11"), double key 6x(8.5"x11"), 9x(8.5"x11") and 12x(8.5"x11") sizes are available and can be used both in portrait & landscape positions. The cover can be opened to 90 degrees. Each unit includes mounting screw and plugs for easy wall mounting and a free set of pins. The profile width is 1.77" and the depth of the case 1.42".

Each product includes 1 key set of single variation.

Each unit includes a free of pins. 2 stays at each end help to keep the cover door open.

Please discard the protective film on the unit before use

Size of boards for all Showboard models:

| 4x(8.5"x11") | | 6x(8.5"x11") | | 9x(8.5"x11") | | 12x(8.5"x11") | |
|--------------|------------|--------------|------------|--------------|------------|---------------|------------|
| (8.5"x11") | (8.5"x11") | (8.5"x11") | (8.5"x11") | (8.5"x11") | (8.5"x11") | (8.5"x11") | (8.5"x11") |
| (8.5"x11") | (8.5"x11") | (8.5"x11") | (8.5"x11") | (8.5"x11") | (8.5"x11") | (8.5"x11") | (8.5"x11") |
| (8.5"x11") | (8.5"x11") | (8.5"x11") | (8.5"x11") | (8.5"x11") | (8.5"x11") | (8.5"x11") | (8.5"x11") |
| (8.5"x11") | (8.5"x11") | (8.5"x11") | (8.5"x11") | (8.5"x11") | (8.5"x11") | (8.5"x11") | (8.5"x11") |



Blue



Gray



Green

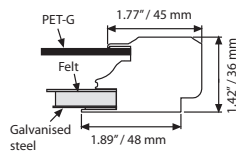
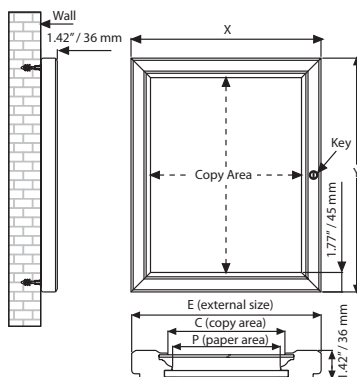

Choice of 4 felt colours



| MATERIAL - Silver anodised aluminium | | | | | | | WEIGHT | PACKING SIZE |
|--------------------------------------|------------|------------|-----------------|-----------------|-----------------|-------------------|--------------|-------------------------|
| BLUE | GRAY | GREEN | EXTERNAL (x-y) | COPY | PAPER AREA | CAPACITY | WITH PACKING | *W X H X D |
| USBN1204A4 | USBN1404A4 | USBN1304A4 | 23.03" X 29.72" | 19.49" X 26.18" | 19.02" X 25.71" | 4 X (8.5" X 11") | 18.629 lbs | 24.41" X 30.71" X 2.36" |
| USBN1206A4 | USBN1406A4 | USBN1306A4 | 23.03" X 42.32" | 19.49" X 38.78" | 19.02" X 38.31" | 6 X (8.5" X 11") | 22.928 lbs | 24.41" X 43.31" X 2.36" |
| USBN1209A4 | USBN1409A4 | USBN1309A4 | 32.09" X 42.32" | 28.54" X 38.78" | 28.07" X 38.31" | 9 X (8.5" X 11") | 31.085 lbs | 33.46" X 43.31" X 2.36" |
| USBN1212A4 | USBN1412A4 | USBN1312A4 | 41.14" X 42.32" | 37.60" X 38.78" | 37.13" X 38.31" | 12 X (8.5" X 11") | 39.683 lbs | 42.52" X 43.31" X 2.36" |



*W:Width H: Height D: Depth

Noticeboards

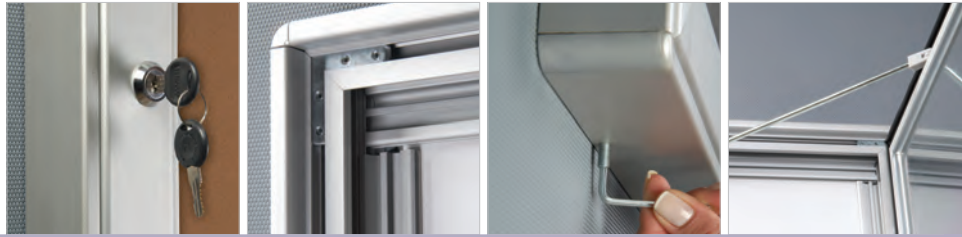

Suitable for outdoor use. 4x(8.5"x11"), 6x(8.5"x11"), 9x(8.5"x11"), 12x(8.5"x11") paper capacity sizes are available. Noticeboard can be used both in portrait and landscape positions. Each unit includes a free set of pins or magnets. The profile width is 2.76" and the depth of the case 1.97".

Each product includes 2 mounting arms, 1 key set single variation & fixing set.

Each unit comes with a free set of magnets. 2 handles at each end help to keep the cover door open.

Please do not drill the product while mounting, only use the mounting arms. Please throw away the protection film on the unit before use.



Cork



Magnetic

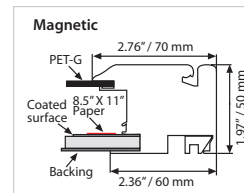
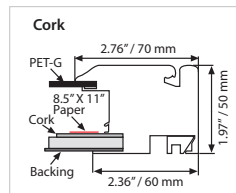
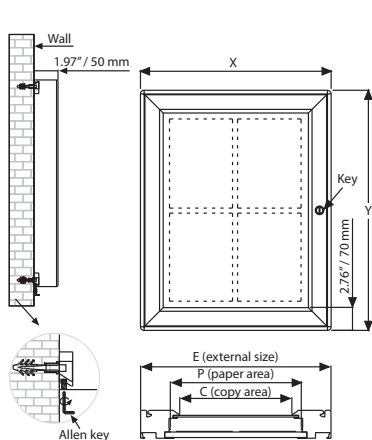

| MATERIAL : Silver anodised aluminium | | | | | | | WEIGHT WITH PACKING | | | PACKING SIZE |
|--------------------------------------|------------|-----------------|-----------------|-----------------|-------------------|------------|---------------------|------------|--------------------------|--------------|
| CORK | MAGNETIC | EXTERNAL (x-y) | PAPER AREA | COPY | CAPACITY | CORK | MAGNETIC | M&C | *W X H X D | |
| UNBN0004A4 | UNBN1004A4 | 23.23" X 29.92" | 19.02" X 25.71" | 17.72" X 24.41" | 4 X (8.5" X 11") | 18.739 lbs | 21.495 lbs | 21.495 lbs | 24.41" X 30.71" X 3.15" | |
| UNBN0006A4 | UNBN1006A4 | 23.23" X 42.52" | 19.02" X 38.31" | 17.72" X 37.01" | 6 X (8.5" X 11") | 24.802 lbs | 29.409 lbs | 29.321 lbs | 24.41" X 43.31" X 3.15" | |
| UNBN0009A4 | UNBN1009A4 | 32.28" X 42.52" | 28.07" X 38.31" | 26.77" X 37.01" | 9 X (8.5" X 11") | 32.187 lbs | 38.801 lbs | 38.801 lbs | 33.46" X 43.31" X 3.15" | |
| UNBN0012A4 | UNBN1012A4 | 41.34" X 42.52" | 37.13" X 38.31" | 35.83" X 37.01" | 12 X (8.5" X 11") | 40.344 lbs | 48.986 lbs | 47.289 lbs | 42.52" X 43.31" X 3.115" | |



* W:Width H: Height D: Depth

Noticeboard with Led Light



Suitable for outdoor use. LEDs on the top and the bottom of the profile illuminate the interior of the frame. 4x(8.5"x11"), 6x(8.5"x11"), 9x(8.5"x11") and 12x(8.5"x11") paper capacity sizes are available. Noticeboard can be used both in portrait and landscape positions. Each unit includes a free set of pins or magnets. The profile width is 2.76" and the depth of the case 1.97".

Each product includes 2 mounting arms, 1 key set single variation & fixing set. Delivered with 3,5 meter long EU plug and cable. UK and US plug should be specified with order. All units pass CE/UL Pat test.

Each unit comes with a free set of pins. 2 handles at each end help to keep the cover door open.

Please throw away the silicagel on the cork once the unit is opened. Please do not drill the product while mounting, only use the mounting arms. Please throw away the protection film on the unit before use.



Magnetic



Cork



Size of boards for all Noticeboards models:

| 4x(8.5"x11") | | 6x(8.5"x11") | | 9x(8.5"x11") | | 12x(8.5"x11") | |
|--------------|------------|--------------|------------|--------------|------------|---------------|------------|
| (8.5"x11") | (8.5"x11") | (8.5"x11") | (8.5"x11") | (8.5"x11") | (8.5"x11") | (8.5"x11") | (8.5"x11") |
| (8.5"x11") | (8.5"x11") | (8.5"x11") | (8.5"x11") | (8.5"x11") | (8.5"x11") | (8.5"x11") | (8.5"x11") |
| (8.5"x11") | (8.5"x11") | (8.5"x11") | (8.5"x11") | (8.5"x11") | (8.5"x11") | (8.5"x11") | (8.5"x11") |
| (8.5"x11") | (8.5"x11") | (8.5"x11") | (8.5"x11") | (8.5"x11") | (8.5"x11") | (8.5"x11") | (8.5"x11") |

| MATERIAL: Silver anodised aluminium | | | | | | WEIGHT WITH PACKING | | | PACKING SIZE |
|-------------------------------------|------------|-----------------|-----------------|-----------------|------------------|---------------------|------------|------------|-------------------------|
| CORK | MAGNETIC | EXTERNAL (x-y) | PAPER AREA | COPY | CAPACITY | CORK | MAGNETIC | M&C | *W X H X D |
| UNBNOL04A4 | UNBN1L04A4 | 23.23" X 29.92" | 19.02" X 25.71" | 17.72" X 24.41" | 4 X (8.5" X 11") | 18.739 lbs | 21.495 lbs | 21.495 lbs | 24.41" X 30.71" X 3.15" |
| UNBNOL06A4 | UNBN1L06A4 | 23.23" X 42.52" | 19.02" X 38.31" | 17.72" X 37.01" | 6 X (8.5" X 11") | 24.802 lbs | 29.409 lbs | 29.321 lbs | 24.41" X 43.31" X 3.15" |
| UNBNOL09A4 | UNBN1L09A4 | 32.28" X 42.52" | 28.07" X 38.31" | 26.77" X 37.01" | 9 X (8.5" X 11") | 32.187 lbs | 38.801 lbs | 38.801 lbs | 33.46" X 43.31" X 3.15" |



* W:Width H: Height D: Depth

Noticeboard



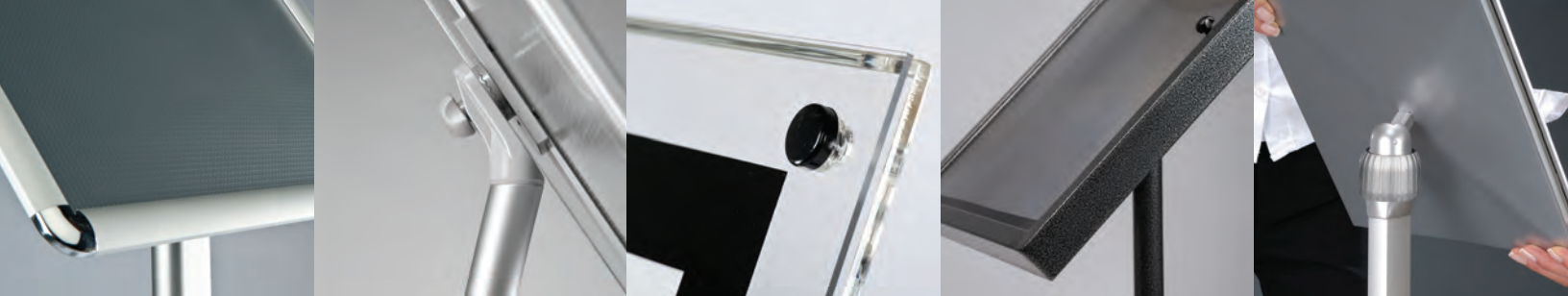

Floor Signs

- Flexible Sign Holders
- Flexible Sign Holder with LEDbox
- Arc Sign Holder
- Telescoping Sign Holders
- Floor Sign Holder
- Folder Sign Holder
- Restaurant Boards
- Curved Sign Holder
- Curved Sign Holder with Acryled
- Universal Showboard on Curved Post
- Paper Board Sign Holder
- Classical Sign Holder
- Decorative Sign Holder
- Adjustable Sign Holder



Flexible Sign Holder



See movie at our website www.mtdisplays.com.tr



Genuine design, one product, multifunctional. With our newly designed product, we would like to bring a new dimension of performance in menuboard. The Flexible Sign Holder fulfills multiple functions thanks to its adjustable height and paper position applications through various standing angles on the back. The height of the unit, the landscape/portrait positioning and the eye catching view angle are all flexible. The product is protected worldwide by all required patent and design applications. It has already been certified in DE (Germany), FR (France), US (United States of America), JP (Japan) and OHIM (European union) papers. The worldwide patent is pending.

Packed unassembled with an easy-to-understand instruction sheet.

Heavy base provides stability in highly frequented areas.



Patent: TR 2007 06354 - TR 2007 03453 - PCT/TR 2007/000131 - DE 20 2007 016 574 - OHIM 000748223-0001,2 - FR 760305 - US 29/295.750 - US D 597, 764 S - JP 2007-022472 - JP 2007-022473 - CN 200730321542.4 - CN 200730321543.

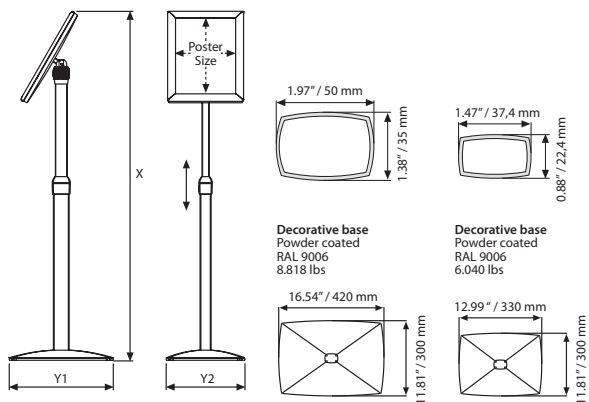

| MATERIAL : Silver anodised aluminium | | | | | | | WEIGHT | PACKING SIZE |
|--------------------------------------|--------|--------|--------|--------|------------|-------------|--------------|-------------------------|
| ARTICLE | X max. | X min. | Y1 | Y2 | POSTER | DESCRIPTION | WITH PACKING | *W X H X D |
| UDMB600581 | 47.44" | 34.06" | 12.99" | 9.84" | 8.5" X 11" | Landscape | 10.141 lbs | 11.22" X 40.55" X 4.02" |
| UDMB600517 | 49.21" | 35.83" | 12.99" | 9.84" | 11" X 17" | Portrait | 10.141 lbs | 11.22" X 40.55" X 4.02" |
| | 51.97" | 37.80" | 16.54" | 11.81" | | Portrait | 13.889 lbs | 14.37" X 43.70" X 4.02" |
| UDMB600518 | 55.51" | 34.25" | 16.54" | 11.81" | 18" X 22" | Landscape | 17.196 lbs | 20.67" X 52.36" X 4.02" |
| | | | | | | Portrait | 17.196 lbs | 20.67" X 52.36" X 4.02" |

*W:Width H: Height D: Depth



Flexible Sign Holder with Fixed Height



See movie at our website www.mtdisplays.com.tr



Genuine design, one product, 2 positions.
 With our newly designed product, we would like to bring a new dimension of performance in menuboard. The Flexible Sign Holder fulfills multiple functions thanks to its paper position applications through various standing angles on the back. The landscape/portrait positioning and the eye catching view angle are all flexible. The product is protected worldwide by all required patent and design applications. It has already been certified in DE (Germany), FR (France), US (United States of America), JP (Japan) and OHIM (European union) papers. The worldwide patent is pending.

Packed unassembled with an easy-to-understand instruction sheet.

Heavy base provides stability in highly frequented areas.



Patent: TR 2007 06354 - TR 2007 03453 - PCT/TR 2007/000131 - DE 20 2007 016 574 - OHIM 000748223-0001,2 - FR 760305 - US 29/295.750 - US D 597, 764 S - JP 2007-022472 - JP 2007-022473 - CN 200730321542.4 - CN 200730321543.

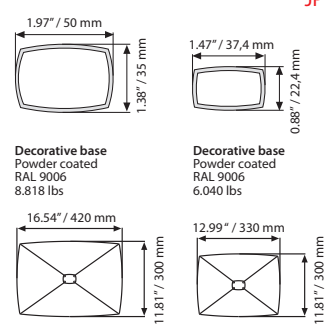
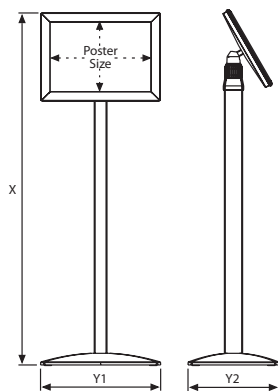

| MATERIAL : Silver anodised aluminium | | | | | WEIGHT | PACKING SIZE |
|--------------------------------------|--------|--------|------------|-------------|--------------|-------------------------|
| ARTICLE | Y1 | Y2 | POSTER | DESCRIPTION | WITH PACKING | *W X H X D |
| UDMB700581 | 12.99" | 9.84" | 8.5" X 11" | Landscape | 11.166 lbs | 11.22" X 40.55" X 4.02" |
| | 12.99" | 9.84" | 8.5" X 11" | Portrait | 11.166 lbs | 11.22" X 40.55" X 4.02" |
| UDMB700517 | 16.54" | 11.81" | 11" X 17" | Landscape | 14.870 lbs | 14.37" X 43.70" X 4.02" |
| | 16.54" | 11.81" | 11" X 17" | Portrait | 14.870 lbs | 14.37" X 43.70" X 4.02" |
| UDMB700518 | 16.54" | 11.81" | 18" X 22" | Landscape | 17.196 lbs | 20.67" X 52.36" X 4.06" |
| | 16.54" | 11.81" | 18" X 22" | Portrait | 17.196 lbs | 20.67" X 52.36" X 4.06" |



*W:Width H: Height D: Depth

Flexible Sign Holder with LEDbox



See movie at our website www.mtdisplays.com.tr

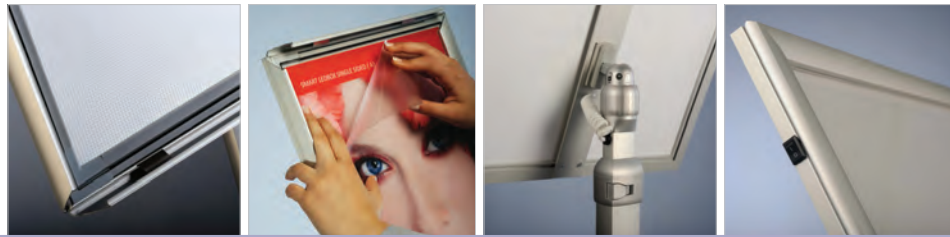

Genuine Design, One product, Multi function. Flexible Sign Holder with Ledbox bring a new dimension of performance in menuboards. It is in multi functional service of height and paper position application with variety of standing angles at the back. The height of the unit, landscape/portrait positioning or even eye catching view angle is flexible. The product is protected in world with all required patent and design applications and already certified with DE (Germany), FR(France), US (United States of America), JP (Japan) and OHIM (European union) papers. PCT worldwide patent is pending. Special treated acrylic and LED technology illuminates prints homogenous. Silver and black models are available in A4&A3 sizes. Black is only available at fixed height.

All units pass CE/UL PAT test. Packed with quality certificates & 3,5 meter electrical cable. UK and US plugs should be mentioned on order. Packed unassembled with an easy instruction sheet.

Led illumination saves up to 60% energy cost. Heavy base provide stability in crowded areas.

Color options : Silver-anodized & black

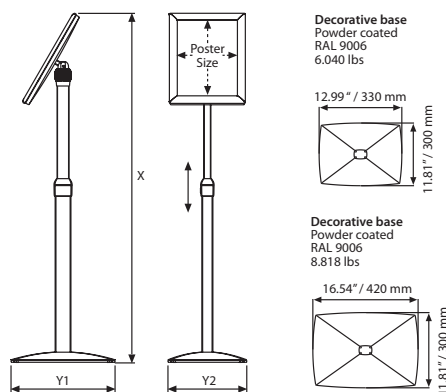

| MATERIAL : Silver anodised aluminium | | | | | | | | WEIGHT | PACKING SIZE |
|--------------------------------------|--------------|--------------|--------|--------|-----------|------------------|---------------|--------------|-------------------------|
| ARTICLE | X max. | X min. | Y1 | Y2 | POSTER | DESCRIPTION | LIGHTING | WITH PACKING | *W X H X D |
| UFML00N017 | 48.50" | 35.12" | 16.54" | 11.81" | 11" X 17" | Silver Landscape | 1800-2200 LUX | 19.841 lbs | 14.57" X 50.79" X 6.10" |
| | 52.05" | 36.30" | 16.54" | 11.81" | | Silver Portrait | 1800-2200 LUX | 19.841 lbs | 14.57" X 50.79" X 6.10" |
| UFML00N018 | 55.63" | 42.24" | 16.54" | 11.81" | 18" X 24" | Silver Landscape | 1800-2100 LUX | 15.432 lbs | 20.67" X 52.36" X 4.06" |
| | 59.06" | 43.31" | 16.54" | 11.81" | | Silver Portrait | 1700-2100 LUX | 15.432 lbs | 20.67" X 52.36" X 4.06" |
| UFML10B017 | fixed height | fixed height | 16.54" | 11.81" | 11" X 17" | Black Landscape | 1900-2100 LUX | 16.424 lbs | 14.76" X 42.13" X 4.33" |
| | fixed height | fixed height | 16.54" | 11.81" | | Black Portrait | 1900-2100 LUX | 16.424 lbs | 14.76" X 42.13" X 4.33" |
| UFML10B018 | fixed height | fixed height | 16.54" | 11.81" | 18" X 24" | Black Landscape | 1800-2200 LUX | 15.432 lbs | 20.67" X 52.36" X 4.06" |
| | fixed height | fixed height | 16.54" | 11.81" | | Black Portrait | 1800-2200 LUX | 15.432 lbs | 20.67" X 52.36" X 4.06" |

*W:Width H: Height D: Depth



ARC Sign Holder



See movie at our website www.mtdisplays.com.tr



Arc Menuboard is a stylish menu or brochure holder with its curved design for modern environment. It is equipped with steel base for stability. anti-reflex magnetic poster cover holds poster in place which enables users to quickly change out messages or prints without having to use any tools. It is a practical solutions for banks, hotels and other businesses to advertise in their lobbies or just restaurants and cafes. It is available in the sizes 8.5"x11" and 11"x17".

- Packed unassembled with easy-to-understand instruction sheet & fixing kit
- Magnetic anti reflex poster cover included.
- 2 packs. See info chart for pack sizes.
- Assembly time approx 40 seconds.

Color options

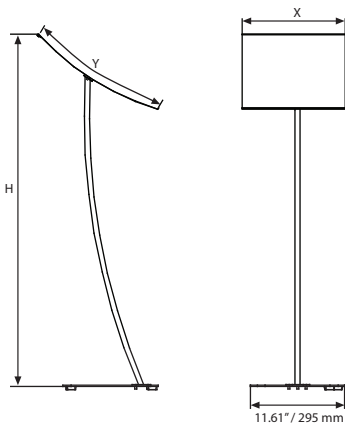

| MATERIAL : Silver anodised aluminium | | | | | | WEIGHT | PACKING SIZE |
|--------------------------------------|-------------|-----------------|------------|-----------------|--------|--------------|-------------------------|
| ARTICLE | DESCRIPTION | EXTERNAL (x-y) | POSTER | COPY | H | WITH PACKING | *W X H X D |
| UAMBOPOB81 | Black | 9.69" X 12.20" | 8.5" X 11" | 8.35" X 10.87" | 42.52" | 10.141 lbs | 12.99" X 39.76" X 3.15" |
| UAMBOPOB17 | Black | 12.13" X 18.19" | 11" X 17" | 10.87" X 16.85" | 44.29" | 11.331 lbs | 14.57" X 40.55" X 3.15" |
| UAMBOPOG81 | Silver | 9.69" X 12.20" | 8.5" X 11" | 8.35" X 10.87" | 42.52" | 10.141 lbs | 12.99" X 39.76" X 3.15" |
| UAMBOPOG17 | Silver | 12.13" X 18.19" | 11" X 17" | 10.87" X 16.85" | 44.29" | 11.331 lbs | 14.57" X 40.55" X 3.15" |

*W:Width H: Height D: Depth



Telescoping Sign Holder Slide-in Frame



See movie at our website www.mtdisplays.com.tr



Telescoping Menuboard Double Sided is equipped with Slide in Frame which provides view from both sides. Its telescoping feature allows adjusting the height of advertisement. Slide-in Frame makes the change of poster easy. It is suitable for use in hotels, galleries, museums, restaurants, lobby, bars, etc. Simply slide out the old protection cover, and then place your double sided poster in between and slide in the frame. A heavy duty steel base stabilizes the height adjustable pole. It is available in the sizes 8.5"x11" and 11"x17" both in landscape & portrait positions in the same Product.

- Telescoping Menuboards are packed unassembled with an easy-to-understand instruction sheet & fixing elements and 2 anti-reflex pet covers.
- Height adjustable with help of clamp.
- Adjustable to portrait or landscape position.
- 1 pack. See info chart for pack sizes.
- Assembly time approx 35 seconds.

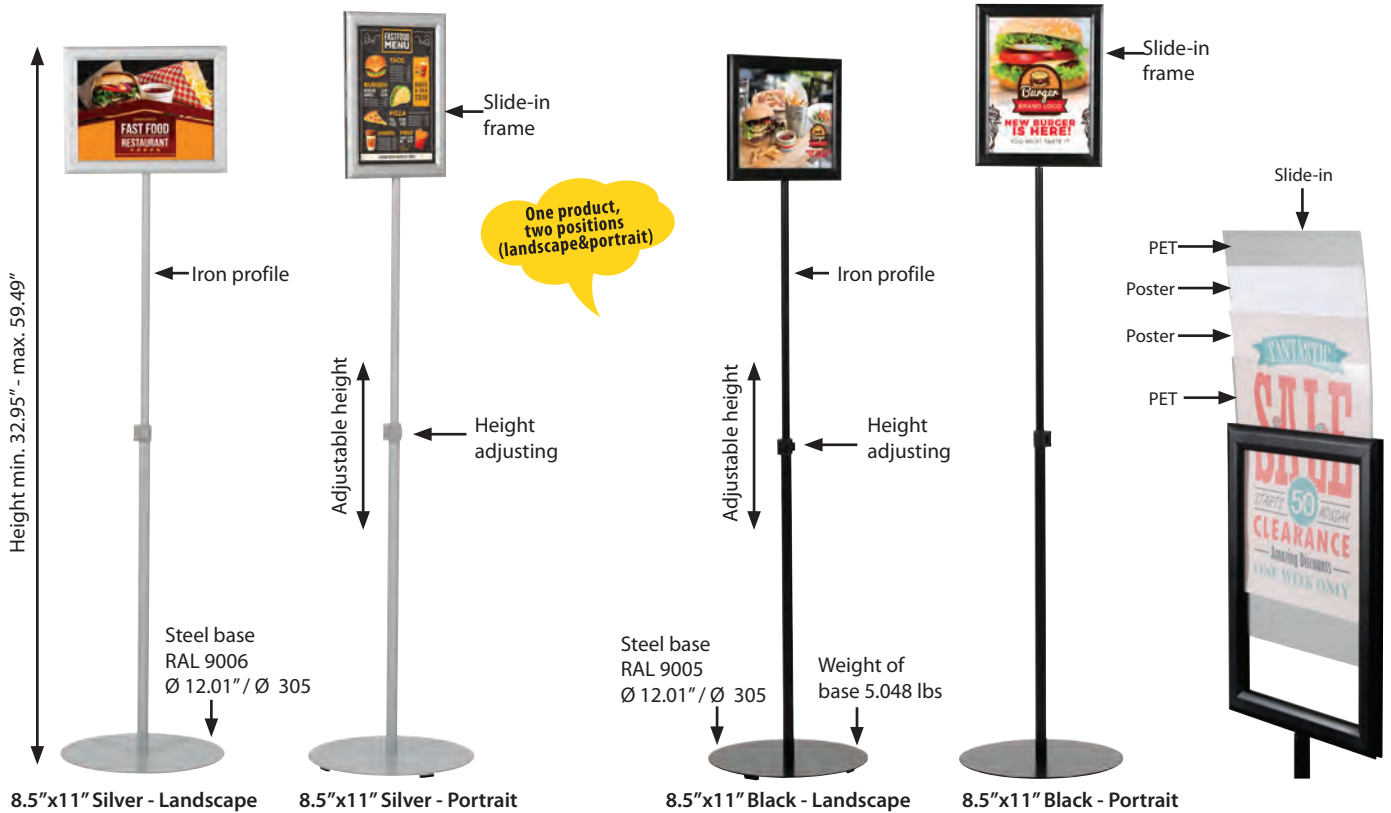

8.5"x11" Silver - Landscape

8.5"x11" Silver - Portrait

8.5"x11" Black - Landscape

8.5"x11" Black - Portrait

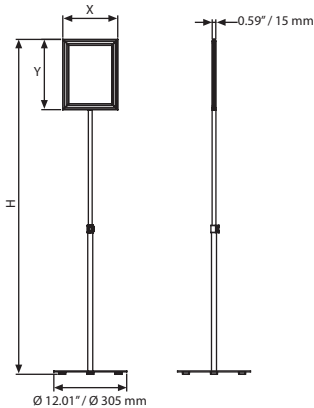

Color options
 Silver
 Black / RAL 9005

| MATERIAL : Silver & black anodised aluminium | | | | | | | WEIGHT | PACKING SIZE |
|--|-----------------|------------|----------------|--------|--------|--------------------|--------------|--------------|
| MITRED ARTICLE | EXTERNAL (x-y) | POSTER | COPY | H min. | H max. | DESCRIPTION | WITH PACKING | *W X H X D |
| UMBD20B81 | 9.16" X 11.57" | 8.5" X 11" | 7.09" X 9.61" | 37.28" | 55.55" | Portrait / Black | | |
| | | | | 32.95" | 51.22" | Landscape / Black | | |
| UMBD20B17 | 11.57" X 17.56" | 11" X 17" | 9.61" X 15.59" | 41.22" | 59.49" | Portrait / Black | | |
| | | | | 37.52" | 55.79" | Landscape / Black | | |
| UMBD20N81 | 9.16" X 11.57" | 8.5" X 11" | 7.09" X 9.61" | 37.28" | 55.55" | Portrait / Silver | | |
| | | | | 32.95" | 51.22" | Landscape / Silver | | |
| UMBD20N17 | 11.57" X 17.56" | 11" X 17" | 9.61" X 15.59" | 41.22" | 59.49" | Portrait / Silver | | |
| | | | | 37.52" | 55.79" | Landscape / Silver | | |

*W:Width H: Height D: Depth



Telescoping Sign Holder Snap Frame



See movie at our website www.mtdisplays.com.tr

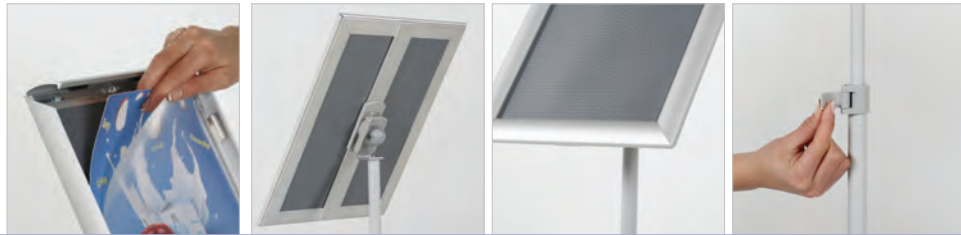

Telescoping Menuboard with Snap Frame, is equipped with Snap Frame which provides landscape and portrait adjustment easily. Its telescoping feature allows adjusting the height of advertisement. Snap Frame makes the change of poster easy. It is suitable for use in hotels, galleries, museums, restaurants, lobby, bars, etc. A heavy duty steel base stabilizes the height adjustable pole. It is available in the sizes 8.5"x11" and 11"x17" both in landscape & portrait positions in the same product.

- Packed unassembled with an easy-to-understand instruction sheet & fixing elements and 1 anti-reflex pet covers. Height adjustable with help of clamp.
- Height adjustable with help of clamp.
- Adjustable to portrait or landscape position.
- 1 pack. See info chart for pack sizes.
- Assembly time approx 35 seconds.

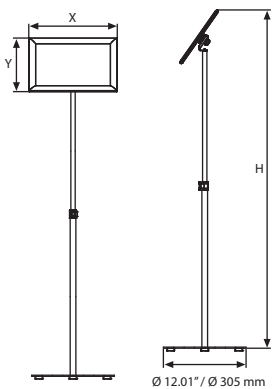
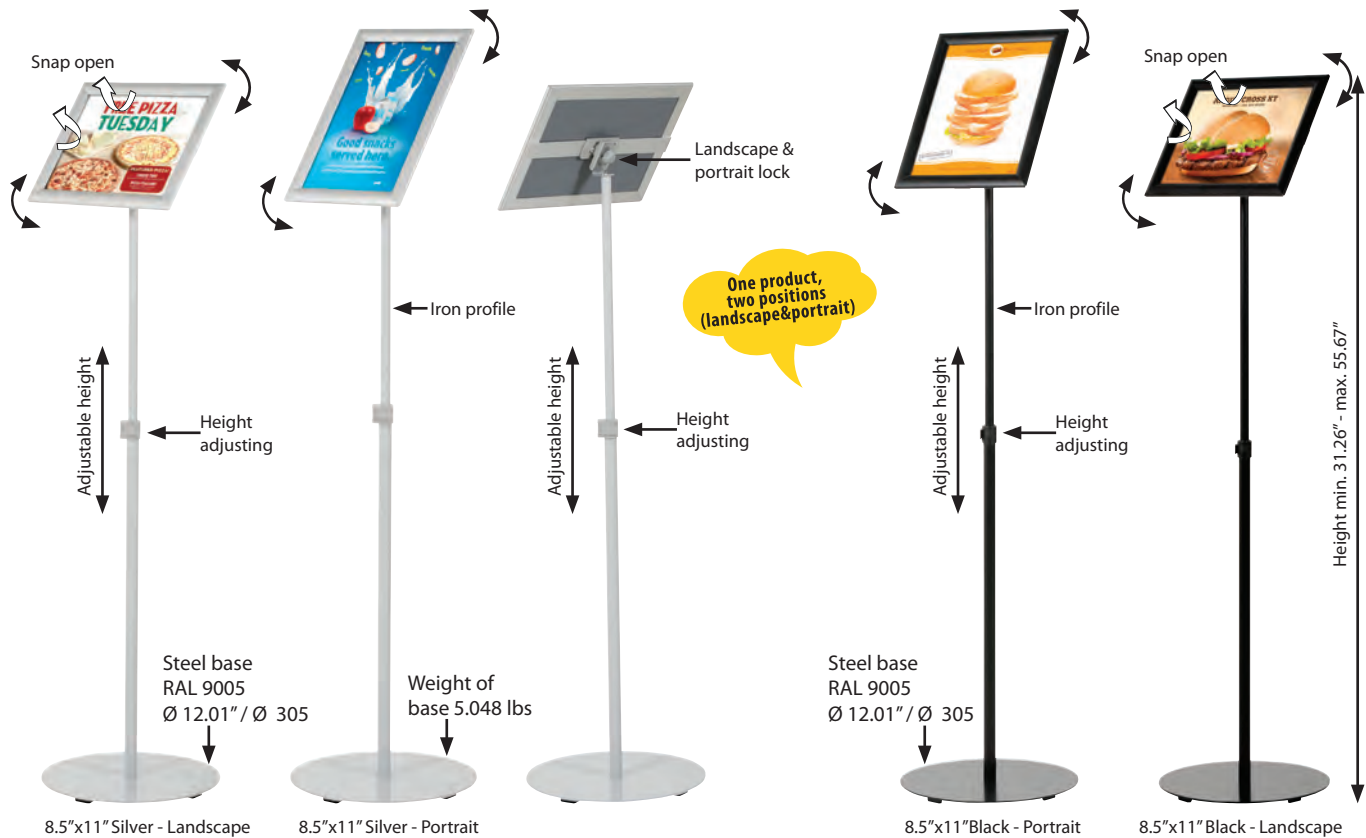

Color options
 Silver
 Black / RAL 9005

| MATERIAL : Silver & black anodised aluminium PROFILE : 25 mm 45° | | | | | | | WEIGHT | PACKING SIZE |
|--|-----------------|------------|-----------------|--------|--------|--------------------|--------------|--------------|
| MITRED ARTICLE | EXTERNAL (x-y) | POSTER | COPY | H min. | H max. | DESCRIPTION | WITH PACKING | *W X H X D |
| UMBTS10B81 | 9.69" X 12.20" | 8.5" X 11" | 7.80" X 10.31" | 33.07" | 51.18" | Portrait / Black | | |
| | | | | 31.26" | 49.37" | Landscape / Black | | |
| UMBTS10B17 | 12.20" X 18.19" | 11" X 17" | 10.31" X 16.69" | 37.40" | 55.67" | Portrait / Black | | |
| | | | | 35.67" | 53.98" | Landscape / Black | | |
| UMBTS10B81 | 9.69" X 12.20" | 8.5" X 11" | 7.80" X 10.31" | 33.07" | 51.18" | Portrait / Silver | | |
| | | | | 31.26" | 49.37" | Landscape / Silver | | |
| UMBTS10B17 | 12.20" X 18.19" | 11" X 17" | 10.31" X 16.69" | 37.40" | 55.67" | Portrait / Silver | | |
| | | | | 35.67" | 53.98" | Landscape / Silver | | |

*W:Width H: Height D: Depth



Floor Sign Holder



See movie at our website www.mtdisplays.com.tr

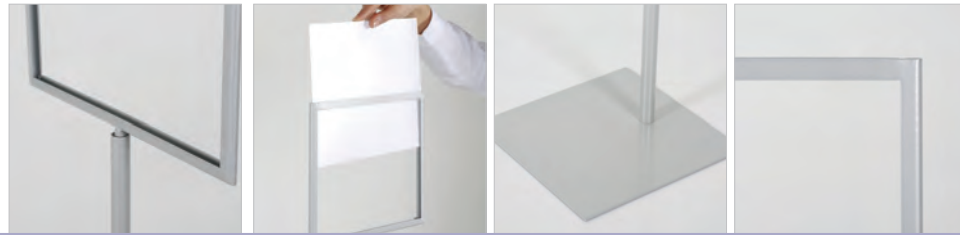

Floor Sign Holder is a landscape sign holder. The graphic is inserted from the top. Steel made of base is heavy which stabilizes the pole. It is double sided to make the advertisement visible from both sides. It is supplied without poster protector. It takes seconds to set up the sign with easy-to-mount instructions. As the pole is 3 parts, it provides 3 height options to Floor sign.



Color options



Silver



Black / RAL 9005

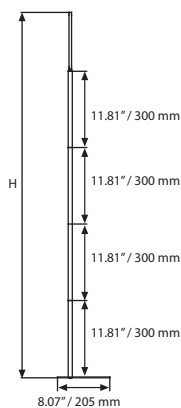
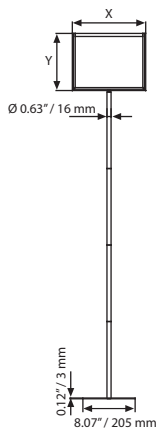
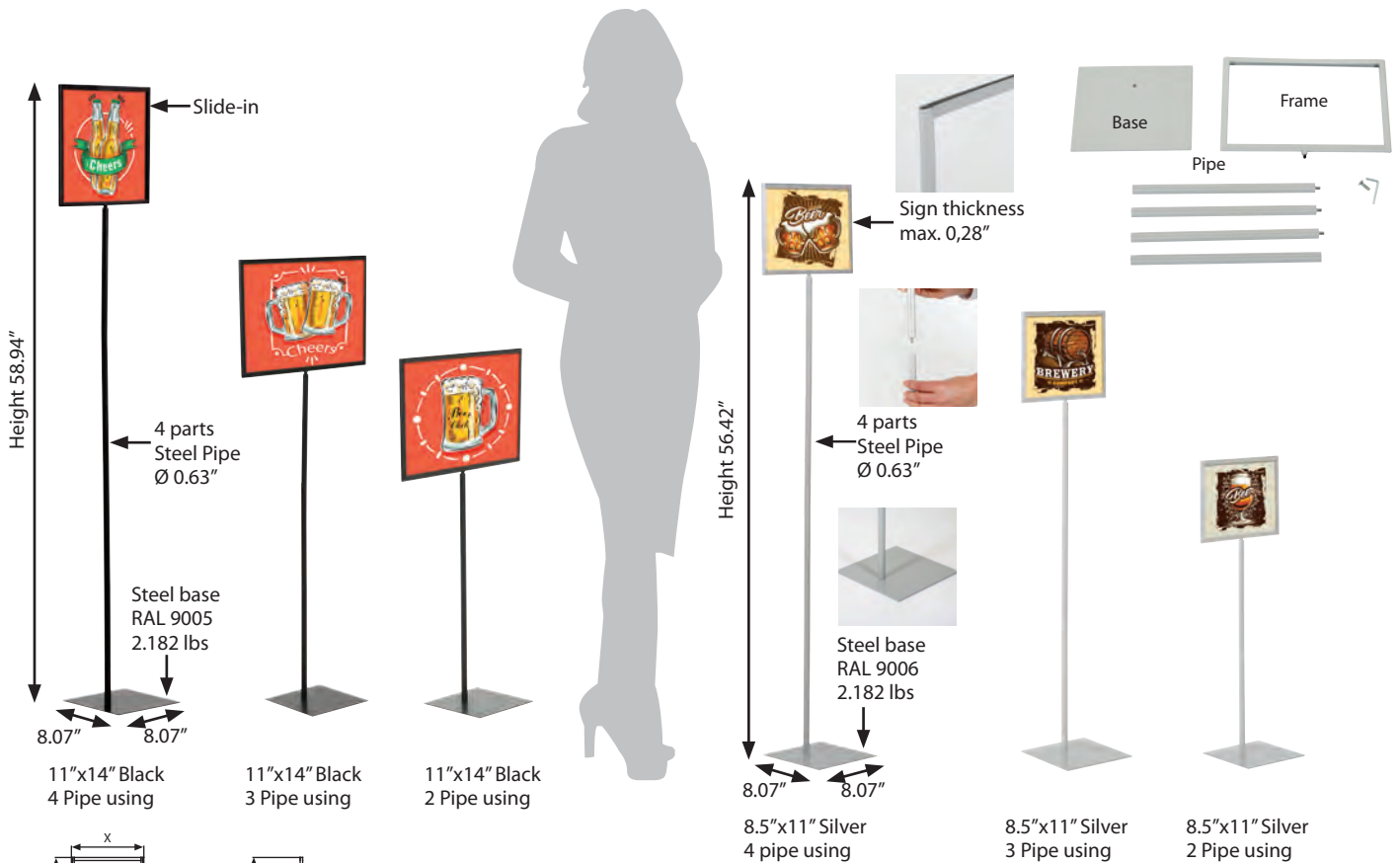

| MATERIAL : Silver & black anodised aluminium | | | | | | WEIGHT | PACKING SIZE |
|--|-----------------|------------|-----------------|--------|---------------------|--------------|--------------|
| ARTICLE | EXTERNAL (x-y) | POSTER | COPY | H max. | DESCRIPTION | WITH PACKING | *W X H X D |
| USHFOP0B81 | 11.34" X 8.82" | 8.5" X 11" | 7.89" X 10.04" | 56.42" | 8.5" X 11" / Black | | |
| USHFOP0G81 | 11.34" X 8.82" | 8.5" X 11" | 7.89" X 10.04" | 56.42" | 8.5" X 11" / Silver | | |
| USHFOP0B14 | 14.33" X 11.34" | 11" X 14" | 10.41" X 13.43" | 58.94" | 11" X 14" / Black | | |
| USHFOP0G14 | 14.33" X 11.34" | 11" X 14" | 10.41" X 13.43" | 58.94" | 11" X 14" / Silver | | |

*W:Width H: Height D: Depth





Folder Sign Holder



See movie at our website www.mtdisplays.com.tr



The Folder Sign Holder has a transparent acrylic shelf catching the eye level. It has a ring binder available to hold 2x4 individual menu pages. With the usage of the channeled elliptic profile and any acrylic or steel shelf, a frame can quickly reveal the advantages of the product.

-  Folder Sign Holders are packed unassembled with an easy-to-understand instruction sheet & fixing elements.
-  Heavy elegant base provides stability.
-  As optional accessory, extra shelves can be added to the leg.

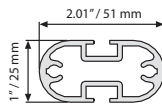
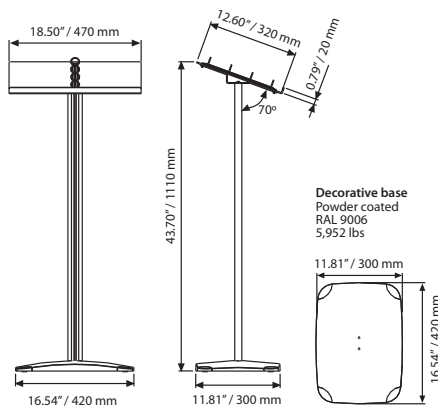

Some possible Variations/Mögliche Variationen.

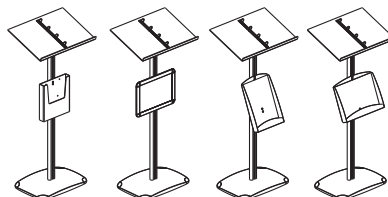

| SHELF | | | WEIGHT | PACKING SIZE |
|------------|-------------------|---------------|--------------|-------------------------|
| ARTICLE | CAPACITY | DESCRIPTION | WITH PACKING | *W X H X D |
| UFSL002100 | 2 X (5.5" X 8.5") | Steel shelf | 3.273 lbs | 13.39" X 11.42" X 2.48" |
| UFSL003100 | 2 X (5.5" X 8.5") | Acrylic shelf | 1.962 lbs | 13.39" X 11.42" X 2.48" |
| UFSL002200 | 1 X (8.5" X 11") | Steel shelf | 2.568 lbs | 9.84" X 14.57" X 2.48" |
| UFSL003200 | 1 X (8.5" X 11") | Acrylic shelf | 1.785 lbs | 9.84" X 14.57" X 2.48" |
| UFSL003300 | 1 X (8.5" X 11") | Acrylic shelf | 1.344 lbs | 9.45" X 10.63" X 2.17" |

| MATERIAL : Silver anodised aluminium | | WEIGHT | PACKING SIZE |
|--------------------------------------|------------------|--------------|-------------------------|
| ARTICLE | CAPACITY | WITH PACKING | *W X H X D |
| UDMB2002A4 | 2 X (8.5" X 11") | 15.101 lbs | 14.96" X 42.13" X 1.97" |



*W:Width H: Height D: Depth

Restaurant Boards

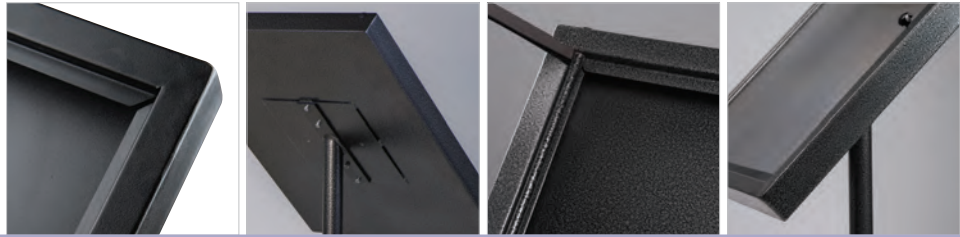

Heavy duty outdoor Restaurant board is ideal for displaying menus, special offers, events and more. Restaurant Boards are designed smart to cover magnetic tape on the cover with Black silk screen printing. These versatile menuboards are produced with durable steel material to suit outdoor conditions. Steel base covered with soft material to protect the floors. Textured black or Black-Grey finishes offers options to users. It is easy to change the message. It captures the customer's attention in all frequented traffic areas.

-  Suitable for outdoor use.
-  Magnets included in each product. Magnetic cover .
-  Single leg can be adjusted to portrait or landscape position.
-  4 packs. See info chart for pack sizes.



Black

Black Hammered

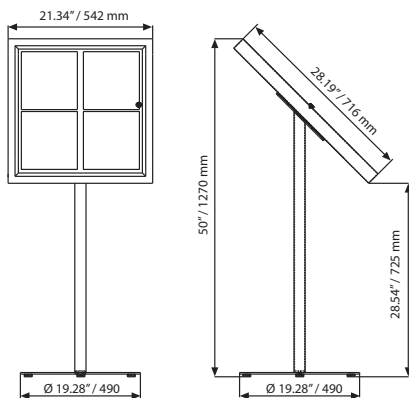

Magnetic buttons
UYUP397000

 Color options :
Black & hammered black

| MATERIAL : Black & black hammered powder coated | | | | WEIGHT | PACKING SIZE |
|---|------------------|----------------|--------------------|--------------|-------------------------|
| ARTICLE | CAPACITY | DESCRIPTION | HEIGHT | WITH PACKING | *W X H X D |
| UMB00B04A4 | 4 X (8.5" X 11") | Black | 50" / Portrait | 52.029 lbs | 8.66" X 44.09" X 2.76" |
| | | | | | 22.83" X 28.35" X 2.76" |
| UMB00N04A4 | 4 X (8.5" X 11") | Hammered Black | 47.44" / Landscape | 52.029 lbs | 8.66" X 44.09" X 2.76" |
| | | | | | 22.83" X 28.35" X 2.76" |
| | | | | | 24.02" X 2.76" X 0.31" |



*W:Width H: Height D: Depth

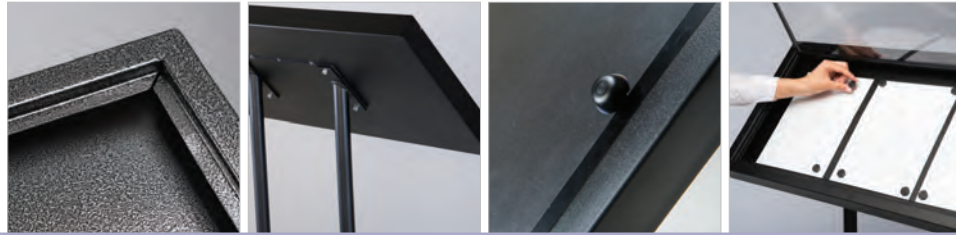

Restaurant Boards



Heavy duty outdoor Restaurant board is ideal for displaying menus, special offers, events and more. Restaurant Boards are designed smart to cover magnetic tape on the cover with Black silk screen printing. These versatile menuboard are produced with durable steel material to suit outdoor conditions. Steel base covered with soft material to protect the floors. Textured black or Black-Grey finishes offers options to users. It is easy to change the message. It captures the customer's attention in all frequented traffic areas.

-  Suitable for outdoor use.
-  Magnets included in each product. Magnetic cover .
-  4 packs. See info chart for pack sizes.



Black

Black Hammered

Powder coated base 24.250 lbs

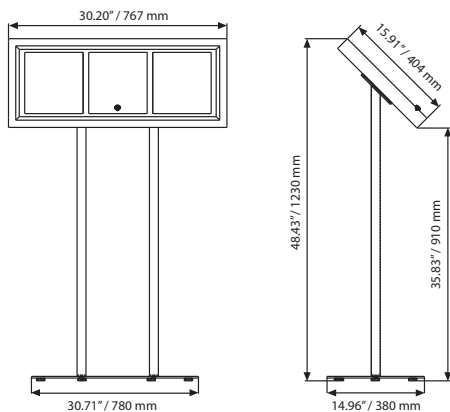

Magnetic buttons
UYUP397000

Color options :
Black & hammered black

| MATERIAL : Black & black hammered powder coated | | | WEIGHT | PACKING SIZE |
|---|------------------|----------------|--------------|-------------------------|
| ARTICLE | CAPACITY | DESCRIPTION | WITH PACKING | *W X H X D |
| UMB00B03A4 | 3 X (8.5" X 11") | Black | 48.060 lbs | 16.54" X 32.28" X 1.18" |
| | | | | 17.32" X 34.65" X 0.31" |
| UMB00N03A4 | 3 X (8.5" X 11") | Hammered Black | 48.060 lbs | 16.54" X 32.28" X 1.18" |
| | | | | 17.32" X 34.65" X 0.31" |

*W:Width H: Height D: Depth



Curved Sign Holder



See movie at our website www.mtdisplays.com.tr



The Curved Sign Holder has both a silver & a black finish. Our new stylish Curved Sign Holder captures the customers attention in all frequented traffic areas. The Curved Sign Holder is suitable for use in hotels, galleries, museums, restaurants, lobby bars, etc.. It is available in 8.5" x 11" and 11" x 17" portrait and landscape positions.

Menu boards are packed unassembled with complete instructions and fixing hardware for assembly.

Heavy elegant base provides stability.

Color options :
Silver-anodized & black

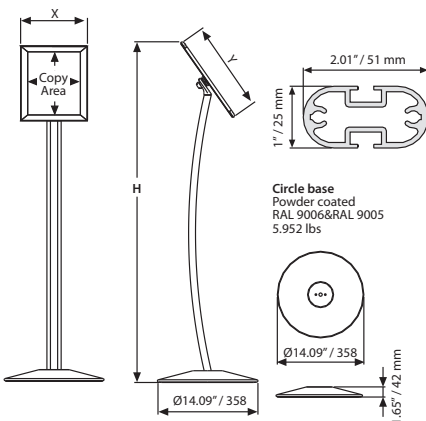

| MATERIAL : Silver & Black anodised aluminium | | | | | | | | WEIGHT | PACKING SIZE |
|--|--------------|--------------|-----------------|------------|-----------------|--------|-------------|--------------|-------------------------|
| MITRED SILVER | ROUND SILVER | MITRED BLACK | EXTERNAL (x-y) | POSTER | COPY | HEIGHT | DESCRIPTION | WITH PACKING | *W X H X D |
| UCUMBN0581 | UCUMBN0081 | UCUMBB0581 | 9.68" X 12.18" | 8.5" X 11" | 7.79" X 10.29" | 47.72" | Portrait | 12.169 lbs | 20.67" X 52.36" X 4.06" |
| | | | | | | 46.30" | Landscape | | |
| UCUMBN0517 | UCUMBN0017 | UCUMBB0517 | 12.18" X 18.18" | 11" X 17" | 10.29" X 16.29" | 49.69" | Portrait | 12.389 lbs | 14.37" X 43.70" X 4.02" |
| | | | | | | 47.72" | Landscape | | |
| UCUMBN0512 | UCUMBN0012 | UCUMBB0512 | 19.18" X 23.18" | 18" X 22" | 17.29" X 21.29" | 53.43" | Portrait | 15.211 lbs | 23.62" X 42.52" X 2.56" |
| | | | | | | 50.91" | Landscape | | |

* W:Width H: Height D: Depth



Curved Sign Holder with Acryled



See movie at our website www.mtdisplays.com.tr



Curved Sign Holder with Acryled has both silver & black finish. Curved Sign Holder is suitable to use in hotels, galleries, museums, restaurants, lobby, bars. Available in 8.5" X 11" and 11" X 17" portrait and landscape positions. Special treated acrylic and LED technology illuminates prints homogenous. The edgelit Acryled mounts on Curved Sign Holder both portrait & landscape. Poster placed in position by 2 clear clips on 2 short sides.

All units pass CE/UL PAT test. Packed with quality certificates & 3,5 meter electrical cable. UK and US plugs should be mentioned on order.

Led illumination saves up to 60% energy cost. Heavy base provide stability.

Color options :
Silver-anodized & black

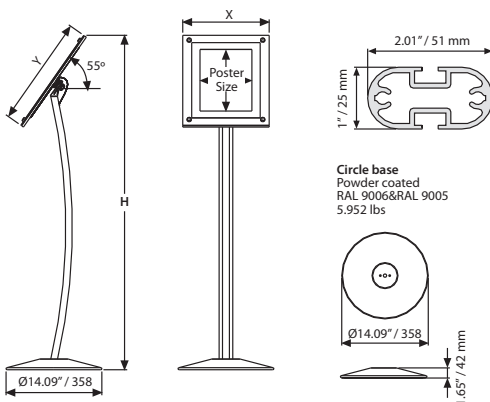

| MATERIAL : Silver & Black anodised aluminium | | | | | | | WEIGHT | PACKING SIZE |
|--|------------|-----------------|------------|------------------|--------|-------------|--------------|-------------------------|
| SILVER | BLACK | EXTERNAL (x-y) | POSTER | COPY | HEIGHT | DESCRIPTION | WITH PACKING | *W X H X D |
| UCUALN0081 | UCUALB0081 | 12.95" X 16.14" | 8.5" X 11" | 7.79" X 10.29" | 49.21" | Portrait | 15.763 lbs | 14.37" X 43.70" X 4.02" |
| | | | | | 47.83" | Landscape | | |
| UCUALN0017 | UCUALB0017 | 16.14" X 20.98" | 11" X 17" | 10.259" X 16.29" | 51.30" | Portrait | 18.408 lbs | 30.87" X 53.15" X 4.33" |
| | | | | | 49.21" | Landscape | | |



*W:Width H: Height D: Depth

Universal Showboard on Curved Post



New stylish curved-pole free standing message board captures the customers' attention in all frequented traffic areas. Suitable in use for restaurants, bars, fastfood and more. Very heavy rubberised base keeps Universal Showboard on Curved Post stable. The hidden lock at the side of the frame prevents unnecessary access to poster. Universal Showboard on Curved Post allows portrait or landscape poster to be used on the same unit.

-  Suitable for outdoor use.
-  Stays and magnets included.
-  Adjustable to portrait or landscape position.
-  3 packs. See info chart for pack sizes.



One product, two positions (landscape & portrait)

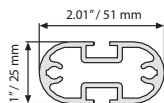
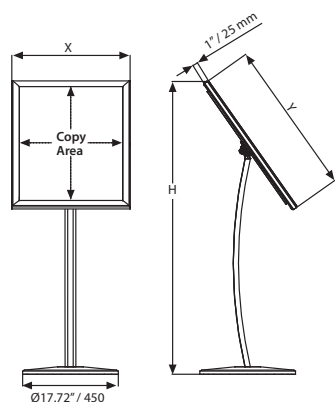

Magnetic buttons UYUP397000

| MATERIAL : Silver & Black anodised aluminium | | | | | | WEIGHT | PACKING SIZE |
|--|-----------------|-----------------|------------------|-------------|--------------------|--------------|-------------------------|
| ARTICLE | EXTERNAL (x-y) | COPY | CAPACITY | DESCRIPTION | HEIGHT | WITH PACKING | *W X H X D |
| UCUS2B0481 | 22.05" X 28.74" | 19.25" X 25.94" | 4 X (8.5" X 11") | Cork | 54.33" / portrait | 35.714 lbs | 2.36" X 41.73" X 3.62" |
| | | | | | 51.77" / landscape | | 23.23" X 29.92" X 2.36" |
| UCUS3B0481 | 22.05" X 28.74" | 19.25" X 25.94" | 4 X (8.5" X 11") | Magnetic | 54.33" / portrait | 35.714 lbs | 2.36" X 41.73" X 3.62" |
| | | | | | 51.77" / landscape | | 23.23" X 29.92" X 2.36" |





* W:Width H: Height D: Depth

Paper Board Sign



Snap open design free standing paper holder, Paper Board Sign Holder is provided with two clear clips for each paper. It is practical to change the poster when the message is changed. Heavy rubberised base keeps Paper Board Sign Holder stable. One product can present 4 x (8.5" X 11") letter size. It features complete Black finish which differentiates Paper Board Sign Holder from many others.

 Indoor use.

 Complete with anti-reflex PET cover.

 3 packs. See info chart for pack sizes.

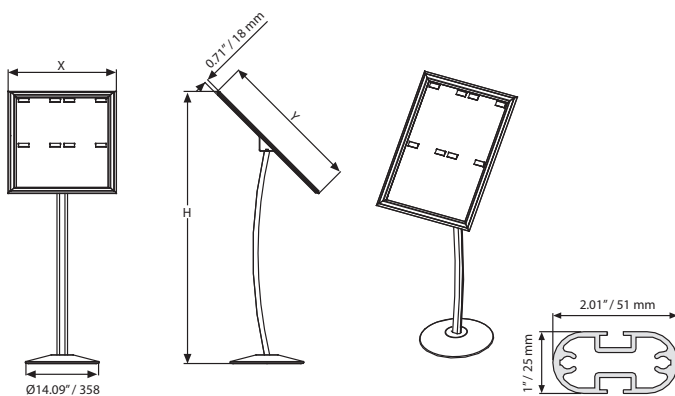

| MATERIAL : Silver & Black anodised aluminium | | | | | WEIGHT | PACKING SIZE |
|--|-----------------|-----------------|------------------|--------|--------------|--|
| ARTICLE | EXTERNAL (x-y) | PAPER AREA | CAPACITY | HEIGHT | WITH PACKING | *W X H X D |
| UCUP0B0481 | 20.55" X 27.32" | 17.40" X 24.17" | 4 X (8.5" X 11") | 51.57" | 23.148 lbs | 2.36" X 41.73" X 3.62" 19.29" X 19.29" X 0.20" 23.23" X 29.92" X 2.36" |





*W:Width H: Height D: Depth

Classical Sign Holder



The Sign Holder with a sight angle that catches the eye level. It is available in the sizes 8.5" X 11" and 11" X 17" both in landscape & portrait positions.

 Menu boards are packed unassembled with an easy-to-understand instruction sheet & fixing elements.

 Suitable for wet floors.



Classical base
RAL 9006 powder coated steel base with plastic cover. 0.42". 3.527 lbs.

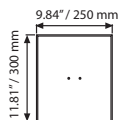

Classical base
RAL 9006 powder coated steel base with plastic cover. 0.42". 9.479 lbs.

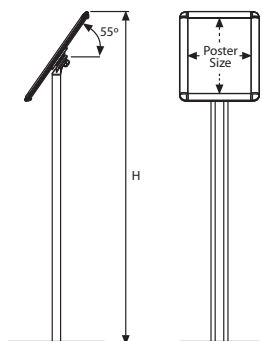
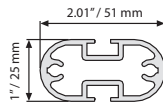
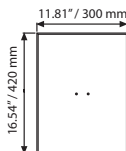

| MATERIAL : Silver anodised aluminium | | | | | | | WEIGHT | PACKING SIZE |
|--------------------------------------|---------------|-----------------|------------|-----------------|--------|-------------|--------------|-------------------------|
| MITRED ARTICLE | ROUND ARTICLE | EXTERNAL (x-y) | POSTER | COPY | HEIGHT | DESCRIPTION | WITH PACKING | *W X H X D |
| UCMB1N0581 | UCMB1N0081 | 9.68" X 12.18" | 8.5" X 11" | 7.79" X 10.29" | 38.70" | Portrait | 7.495 lbs | 11.42" X 38.58" X 2.56" |
| | | | | | 38.19" | Landscape | | |
| UCMB1N0517 | UCMB1N0017 | 12.18" X 18.18" | 11" X 17" | 10.29" X 16.29" | 47.72" | Portrait | 12.897 lbs | 14.96" X 45.28" X 2.56" |
| | | | | | 44.61" | Landscape | | |



* W:Width H: Height D: Depth

Decorative Sign Holder



See movie at our website www.mtdisplays.com.tr



The Sign Holder with a sight angle that catches the eye level. The decorative base provides an elegant look. It is available in the sizes 8.5" X 11" and 11" X 17" in portrait & landscape positions.

Sign Holders are packed unassembled with an easy-to-understand instruction sheet & fixing elements.

Heavy elegant base provides stability.

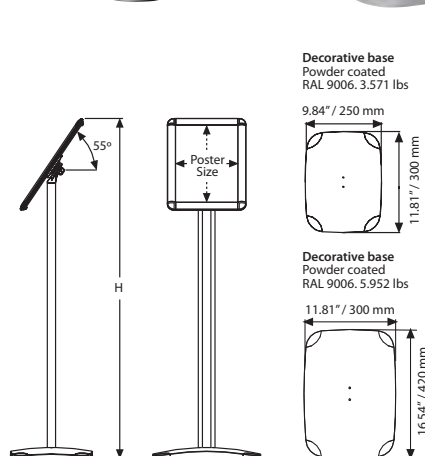

Decorative base
Powder coated
RAL 9006. 3.571 lbs

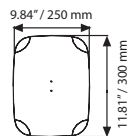

Decorative base
Powder coated
RAL 9006. 5.952 lbs

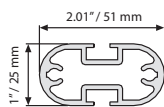
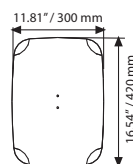

| MATERIAL : Silver anodised aluminium PROFILE : 25 mm 45° - 25 mm Round | | | | | | | WEIGHT | PACKING SIZE |
|--|---------------|-----------------|------------|-----------------|--------|-------------------------------|--------------|-------------------------|
| MITRED ARTICLE | ROUND ARTICLE | EXTERNAL (x-y) | POSTER | COPY | HEIGHT | DESCRIPTION | WITH PACKING | *W X H X D |
| UDMB1N05A4 | UDMB1N00A4 | 9.68" X 12.18" | 8.5" X 11" | 7.79" X 10.29" | 39.37" | 8.5" x 11" portrait / Silver | 8.135 lbs | 11.42" X 35.63" X 2.56" |
| | | | | | 37.95" | 8.5" x 11" landscape / Silver | | |
| UDMB1N05A3 | UDMB1N00A3 | 12.18" X 18.18" | 11" X 17" | 10.29" X 16.29" | 47.24" | 11" x 17" portrait / Silver | 12.897 lbs | 14.96" X 45.28" X 2.56" |
| | | | | | 45.28" | 11" x 17" landscape / Silver | | |
| UDMB1B05A4 | UDMB1B00A4 | 9.68" X 12.18" | 8.5" X 11" | 7.79" X 10.29" | 39.37" | 8.5" x 11" portrait / Black | 8.135 lbs | 11.42" X 35.63" X 2.56" |
| | | | | | 37.95" | 8.5" x 11" landscape / Black | | |
| UDMB1B05A3 | UDMB1B00A3 | 12.18" X 18.18" | 11" X 17" | 10.29" X 16.29" | 47.24" | 11" x 17" portrait / Black | 12.897 lbs | 14.96" X 45.28" X 2.56" |
| | | | | | 45.28" | 11" x 17" landscape / Black | | |



* W:Width H: Height D: Depth

Adjustable Sign Holder



See movie at our website www.mtdisplays.com.tr



The adjustable single-faced and double-faced menuboards are economic floor stands that can hold up to 3 frames both sided at once. They are easily adjustable to the eye level and suitable for various poster sizes in portrait or landscape options. The decorative base provides an elegant look. The items presented in the sizes 8.5" X 11" and 11"x17" are suitable for portrait & landscape positions. 8.5" X 11" P/L Adjustable menuboard, round corners, max. height 1300mm. 11"x17" P/L Adjustable menuboard, round corners, max. height 59.06".

Sign Holders are packed unassembled with an easy-to-understand instruction sheet & fixing elements.

Supplied with stable heavy base, offers various options.



Some possible variations

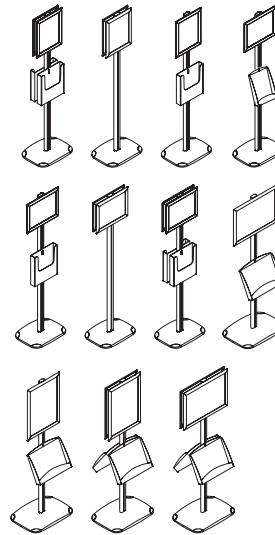

UFSL002100

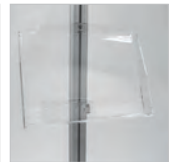

UFSL003100



UFSL002200

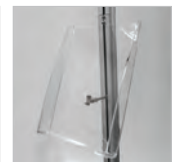

UFSL003200



UFSL003300

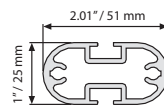
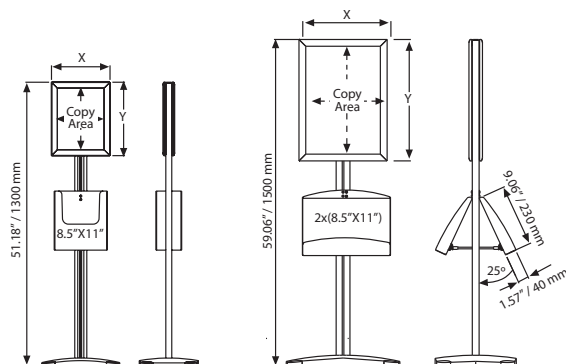

| SHELF | | | WEIGHT | PACKING SIZE |
|------------|-------------------|---------------|--------------|-------------------------|
| ARTICLE | CAPACITY | DESCRIPTION | WITH PACKING | *W X H X D |
| UFSL002100 | 2 X (5.5" X 8.5") | Steel shelf | 3.273 lbs | 13.39" X 11.42" X 2.48" |
| UFSL003100 | 2 X (5.5" X 8.5") | Acrylic shelf | 1.962 lbs | 13.39" X 11.42" X 2.48" |
| UFSL002200 | 1 X (8.5" X 11") | Steel shelf | 2.568 lbs | 9.84" X 14.57" X 2.48" |
| UFSL003200 | 1 X (8.5" X 11") | Acrylic shelf | 1.785 lbs | 9.84" X 14.57" X 2.48" |
| UFSL003300 | 1 X (8.5" X 11") | Acrylic shelf | 1.344 lbs | 9.45" X 10.63" X 2.17" |

| MATERIAL : Silver anodised aluminium | | | | | WEIGHT | PACKING SIZE |
|--------------------------------------|---------------|-----------------|------------|-----------------|--------------|-------------------------|
| MITRED ARTICLE | ROUND ARTICLE | EXTERNAL (x-y) | POSTER | COPY | WITH PACKING | *W X H X D |
| UDMB100581 | UDMB100081 | 9.68" X 12.18" | 8.5" X 11" | 7.79" X 10.29" | 9.369 lbs | 12.80" X 51.18" X 1.77" |
| UDMB100517 | UDMB100017 | 12.18" X 18.18" | 11" X 17" | 10.29" X 16.29" | 14.330 lbs | 12.80" X 58.66" X 1.77" |

*W:Width H: Height D: Depth



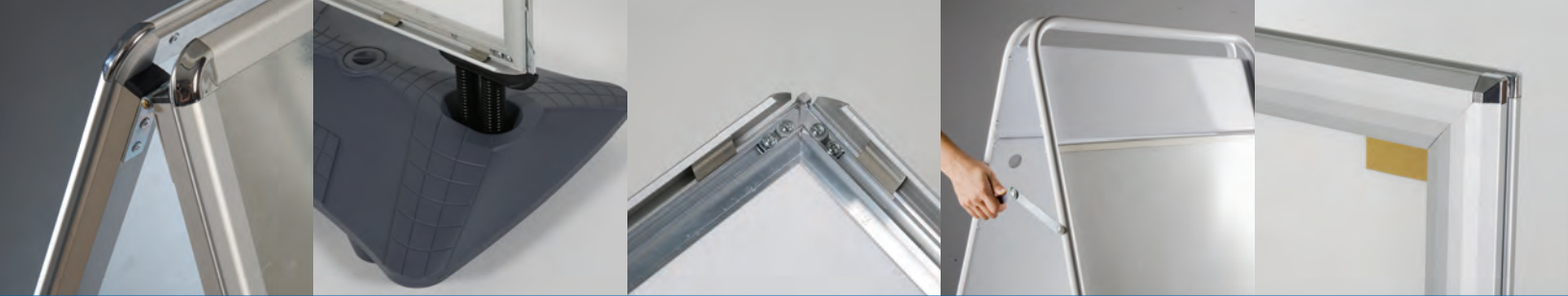

Sidewalk Signs

- A Board
- Eco A Board
- Premium A Board with logo
- Premium A Board with Profile logo
- Weatherproof A Board
- Slide-in A Board
- Easy Go A Board
- Wood Look A Board

- Street SignPro Board
- Street SignPro with Lens
- Street SignPro without Lens
- SwingPro&WindPro Plus
- SwingPro&WindPro Lite
- BannerPro
- Slide-in WindPro®
- Illuminated WindPro® with LED
- Eco Swingmaster

- Eco Waterbase Wind Sign
- Al Maki
- Rectangular Iron A Board
- Magnetic Iron A Board
- Waterbase Pavement Signs
- PS Boards



A Board



See movie at our website www.mtdisplays.com.tr

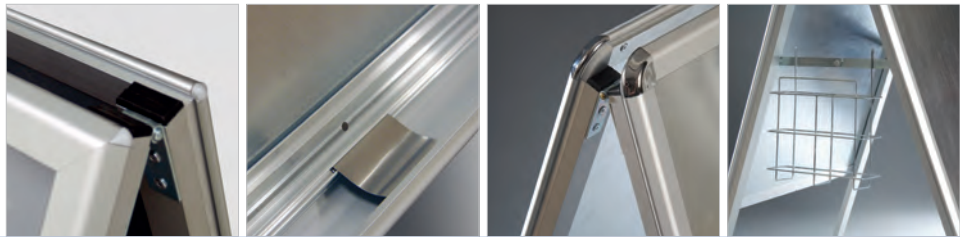

Header board and brochure basket options are available. Easy-to-open snap frame includes the anti-reflex cover in all standard A boards. Frame size alternatives are 20"x30", 22"x28" and 30"x40".

- Single packed with an easy-to-understand instruction sheet.
- Heavy back panel provides stability. No tool assembly. Header accessories are not included. Should be ordered separate.
- Each unit has water drainage slots on bottom profiles.

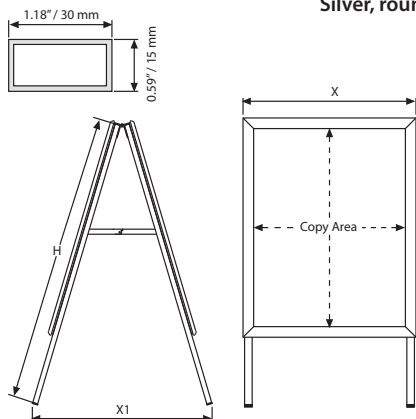

| BASKET | | WEIGHT | PACKING SIZE |
|------------|------------------------|--------------|------------------------|
| ARTICLE | CAPACITY | WITH PACKING | *W X H X D |
| UYTS3000A4 | 8.27" X 11.69" X 2.57" | 1.146 lbs | 9.84" X 11.22" X 3.15" |

| MATERIAL : Silver anodised aluminium | | | | | | | | | WEIGHT | PACKING SIZE |
|--------------------------------------|--------------|--------------|-------------|-------------|-----------|--------|--------|--------|--------------|-------------------------|
| MITRED SILVER | MITRED BLACK | ROUND SILVER | ROUND BLACK | SAFE CORNER | POSTER | X | X1 | H | WITH PACKING | *W X H X D |
| UAB3250N23 | UAB3250B23 | UAB3200N23 | UAB3200B23 | UAB3210N23 | 20" X 30" | 21.69" | 27.56" | 37.40" | 19.841 lbs | 25.59" X 44.09" X 4.41" |
| UAB3250N22 | UAB3250B22 | UAB3200N22 | UAB3200B22 | UAB3210N22 | 22" X 28" | 19.69" | 27.56" | 37.40" | 19.841 lbs | 27.56" X 42.13" X 4.41" |
| UAB3250N34 | UAB3250B34 | UAB3200N34 | UAB3200B34 | UAB3210N34 | 30" X 40" | 31.69" | 33.46" | 49.21" | 30.423 lbs | 31.89" X 50.39" X 4.41" |



*W:Width H: Height D: Depth

Eco A Board

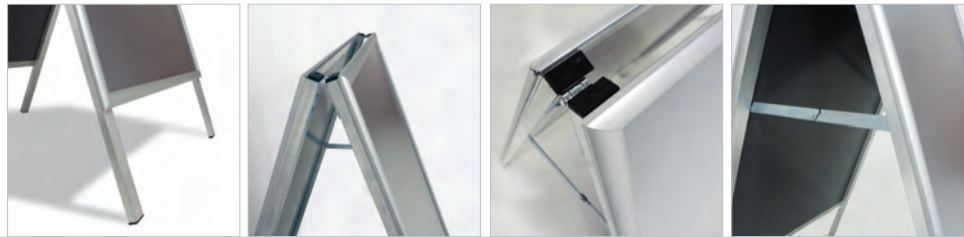

A double-sided customer stopper, practical to change the poster within. 22"X28", 24"X36" sizes are available. 1" profile, snap frame. Round or mitred corner options are available. PS backing for indoor use on Eco Indoor A Board whereas galvanized backing for Eco Outdoor A Board. Both are offered with cost-saving mill finished legs.

Single packed with an easy-to-understand instruction sheet. Put on a high palette & eco packaging is used.

! No tool assembly. Each unit has water drainage slots on bottom profile.



Outdoor - Silver



Indoor - Black



Outdoor - Black



Indoor - Silver

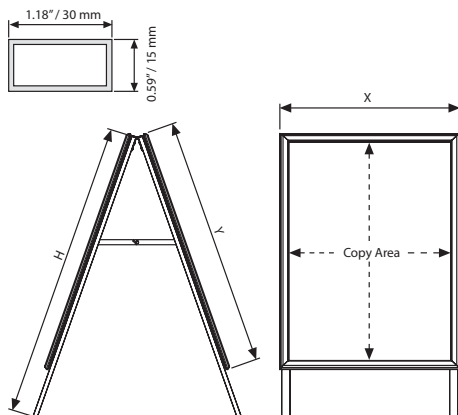

| ECO INDOOR A BOARD: PS Backing + Mill Finish Legs PROFILE : 1" / 25 mm | | | | | | | WEIGHT | PACKING SIZE |
|--|---------------|-----------|-------------|--------|--------|--------|--------------|-------------------------|
| MITRED ARTICLE | ROUND ARTICLE | POSTER | DESCRIPTION | X | Y | H | WITH PACKING | *W X H X D |
| UAB255HN22 | UAB250HN22 | 22" X 28" | Silver | 21.97" | 29.17" | 37.40" | 12.897 lbs | 27.17" X 43.31" X 3.35" |
| UAB255HN24 | UAB250HN24 | 24" X 36" | Silver | 25.20" | 37.20" | 47.24" | 17.306 lbs | 27.95" X 54.72" X 3.35" |
| UAB255HB22 | UAB250HB22 | 22" X 28" | Black | 21.97" | 29.17" | 37.40" | 12.897 lbs | 27.17" X 43.31" X 3.35" |
| UAB255HB24 | UAB250HB24 | 24" X 36" | Black | 25.20" | 37.20" | 47.24" | 17.306 lbs | 27.95" X 54.72" X 3.35" |

| ECO OUTDOOR A BOARD: Galvanized Backing + Mill Finish Legs PROFILE : 1.26" / 32 mm | | | | | | | WEIGHT | PACKING SIZE |
|--|---------------|-----------|-------------|--------|--------|--------|--------------|-------------------------|
| MITRED ARTICLE | ROUND ARTICLE | POSTER | DESCRIPTION | X | Y | H | WITH PACKING | *W X H X D |
| UAB325HN22 | UAB320HN22 | 22" X 28" | Silver | 22.48" | 29.69" | 37.40" | 18.959 lbs | 27.17" X 43.31" X 3.35" |
| UAB325HN24 | UAB320HN24 | 24" X 36" | Silver | 25.20" | 37.20" | 47.24" | 23.368 lbs | 27.95" X 54.72" X 3.35" |
| UAB325HB22 | UAB320HB22 | 22" X 28" | Black | 22.48" | 29.69" | 37.40" | 18.959 lbs | 27.17" X 43.31" X 3.35" |
| UAB325HB24 | UAB320HB24 | 24" X 36" | Black | 25.20" | 37.20" | 47.24" | 23.368 lbs | 27.95" X 54.72" X 3.35" |

*W:Width H: Height D: Depth



Premium A Board with Logo



See movie at our website www.mtdisplays.com.tr



This heavy duty pavement sign is a perfect use for displaying posters and advertising signs with your own logo. Provides practical use, quick change-poster and logo. The replaceable aluminium composite plate is an ideal spot for a logo or a permanent message, suitable for outdoor conditions. You can print your logo directly or laminate on aluminium composite plate. The frame is hinged for easy transport and storage, with a locking stay to secure when open. Standard in silver anodised, available in standard RAL colours upon request with MOQ.

- Single packed with an easy-to-understand instruction sheet.
- Heavy back panel provides stability. No tool assembly.
- Each unit has water drainage slots on bottom profiles.

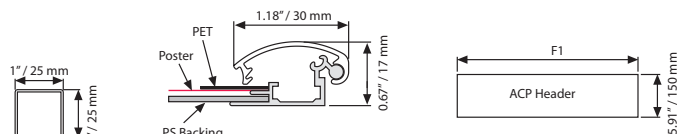
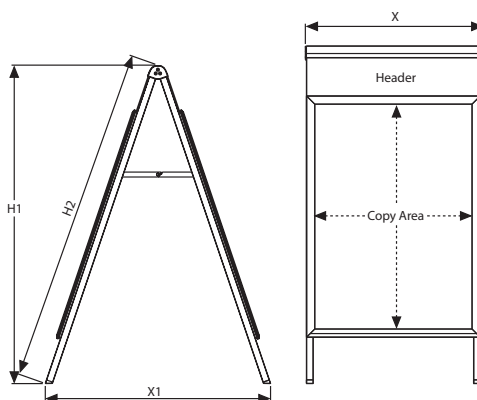

| MATERIAL : Silver anodised aluminium | | | | | | | | | | WEIGHT | PACKING SIZE |
|--------------------------------------|------------|-----------|--------|--------|--------|--------|--------|--------|--------------|-------------------------|--------------|
| SILVER | BLACK | POSTER | X | X1 | H1 | H2 | F1 | FEET | WITH PACKING | *W X H X D | |
| UAP0305N23 | UAP0305B23 | 20" X 30" | 22.01" | 30.51" | 42.91" | 45.67" | 21.69" | 43.66" | 18.739 lbs | 24.02" X 47.64" X 4.53" | |
| UAP0305N22 | UAP0305B22 | 22" X 28" | 24.06" | 32.48" | 40.12" | 42.68" | 23.74" | 41.54" | 25.132 lbs | 25.59" X 46.46" X 4.53" | |
| UAP0305N34 | UAP0305B34 | 30" X 40" | 31.01" | 37.01" | 52.36" | 55.51" | 31.69" | 53.50" | 30.423 lbs | 34.25" X 57.48" X 4.53" | |



*W:Width H: Height D: Depth

Premium A Board with Profile Logo



See movie at our website www.mtdisplays.com.tr



This heavy duty pavement sign is a perfect use for displaying posters and advertising signs with your own logo. Provides practical use, quick change-poster and logo. Aluminium profile is an ideal spot for a logo or a permanent message, suitable for outdoor conditions. You can laminate on aluminium header profile. Galvanised steel backing adds extra strength and stability. The frame is hinged for easy transport and storage, with a locking stay to secure when open. Standard in silver anodised, available in standard RAL colours upon request with MOQ.

Single packed with an easy-to-understand instruction sheet.

Heavy back panel provides stability. No tool assembly. Each unit has water drainage slots on bottom profiles.

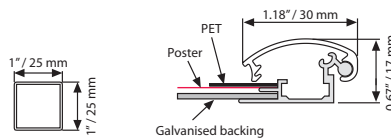
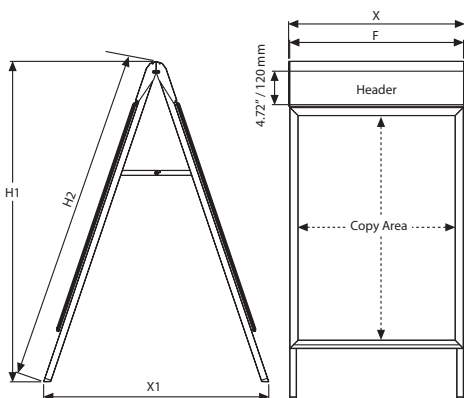

| MATERIAL : Silver anodised aluminium | | | | | | | | | | WEIGHT | PACKING SIZE |
|--------------------------------------|------------|-----------|-----------------|--------|--------|--------|--------|--------|--------|--------------|-------------------------|
| SILVER | BLACK | POSTER | HEADER PRINTING | X | X1 | H1 | H2 | F1 | FEET | WITH PACKING | *W X H X D |
| UAP1305N23 | UAP1305B23 | 20" X 30" | 20" X 4.72" | 22.01" | 30.51" | 42.91" | 45.67" | 21.69" | 43.66" | 18.739 lbs | 24.02" X 47.64" X 4.53" |
| UAP1305N34 | UAP1305B34 | 30" X 40" | 30" X 4.72" | 32.01" | 37.01" | 52.36" | 55.51" | 31.69" | 53.50" | 30.423 lbs | 34.25" X 57.48" X 4.53" |
| UAP1305N22 | UAP1305B22 | 22" X 28" | 22" X 4.72" | 22.20" | 28.94" | 40.55" | 43.11" | 21.89" | 41.10" | 18.408 lbs | 23.62" X 45.28" X 4.53" |

*W:Width H: Height D: Depth



Weatherproof A Board



1.38" weatherproof. Suitable for use under rainy outdoor conditions. When poster is placed inside the water wick, it is protected, weatherproof. Header board and brochure basket options are present. Easy-to-open snap frame includes the anti-reflex cover in all standard A boards. Frame size alternatives are 20"x30", 30"x40" mm.

Single packed with an easy mounting instruction sheet.

No tool assembly. Header accessories are not included. Should be ordered separate.

Each unit has water drainage slots on bottom profiles. Please use pull sticker to take off cover.

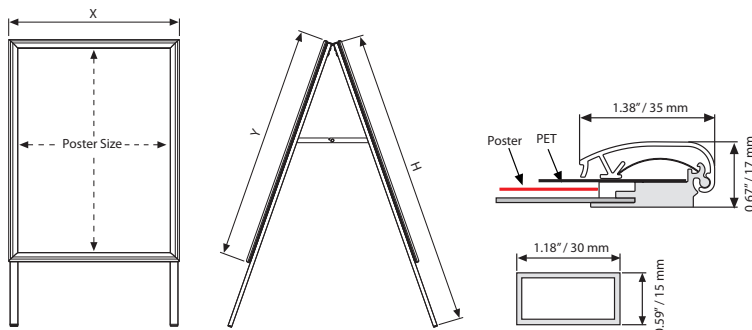

| MATERIAL : Silver anodised aluminium | | | | | WEIGHT | PACKING SIZE |
|--------------------------------------|-----------|--------|--------|--------|--------------|-------------------------|
| ARTICLE | POSTER | X | Y | H | WITH PACKING | *W X H X D |
| UAB3550N22 | 22" X 28" | 24.49" | 28.86" | 37.40" | 17.636 lbs | 25.39" X 41.34" X 4.33" |



*W:Width H: Height D: Depth



Slide-in A Board



See movie at our website www.mtdisplays.com.tr



Top opening Slide-in A Board is a practical product. Suitable for outdoor use. Available in Grey and Black finishes. Poster stands stable in between cover and backing. Rubber feet increase the product life as well as giving a clean finish to Slide-in A Board.

-  Single packed with an easy mounting instruction sheet.
-  Bottom profile of sandwich slide-in panel provide easy application.
-  No tool assembly.

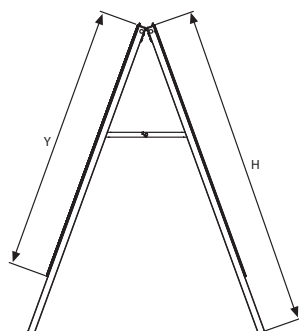
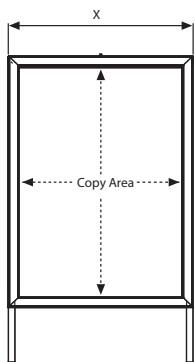
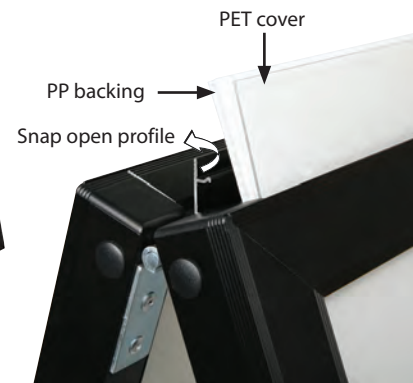

| FRAME : Powder coated aluminium | | | | | | WEIGHT | PACKING SIZE |
|---------------------------------|------------|-----------------|-----------|-----------------|--------|--------------|-------------------------|
| GRAY | BLACK | EXTERNAL (x-y) | POSTER | COPY | H | WITH PACKING | *W X H X D |
| UABSON0022 | UABS0B0022 | 24.24" X 30.24" | 22" X 28" | 21.09" X 27.09" | 45.28" | 16.314 lbs | 25.59" X 38.98" X 3.35" |
| UABSON0024 | UABS0B0024 | 26.24" X 38.24" | 24" X 36" | 23.09" X 35.09" | 45.28" | 23.765 lbs | 28.35" X 50" X 3.35" |
| UABSON0034 | UABS0B0034 | 32.24" X 42.24" | 30" X 40" | 29.09" X 39.09" | 49.21" | 23.258 lbs | 34.65" X 53.94" X 3.35" |



*W:Width H: Height D: Depth



Easy Go A Board



See movie at our website www.mtdisplays.com.tr



Easy go A Board is an ultraportable and easy to use model in A board range. With its unique foldable design, it is easy to carry and set up. There are 3 different panels that can be used in this model; chalkpanel, write-on panel, PVC Foam panel for direct printing. These panels will be slid into the channels of the legs. Suitable for max. 6 mm panels.

-  Unique foldable design. Easy to carry and set up.
-  No tool assembly.
-  Panels excluded. Order separately.



Don't forget to order one of 3 panel options!

Slide-in

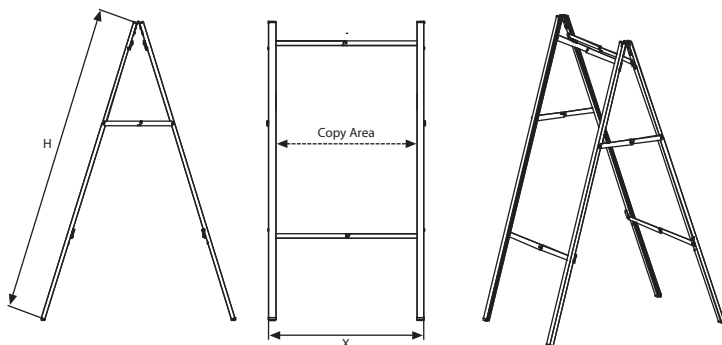

| PANELS | | | | WEIGHT | PACKING SIZE |
|-------------|----------------|----------------|-----------------|--------------|------------------------|
| CHALK PANEL | WRITE-ON PANEL | PVC FOAM PANEL | SIZE | WITH PACKING | *W X H X D |
| UYPEG10022 | UYPEG20022 | UYPEG30022 | 22.01" X 27.99" | 11.243 lbs | 4.53" X 40.16" X 2.56" |
| UYPEG10024 | UYPEG20024 | UYPEG30024 | 24.02" X 35.98" | 13.227 lbs | 4.53" X 48.03" X 2.56" |

| MATERIAL: Silver anodised aluminium - without panel | | | | | WEIGHT | PACKING SIZE |
|---|-----------|-----------------|--------|--------|--------------|------------------------|
| ARTICLE | POSTER | COPY | X | H | WITH PACKING | *W X H X D |
| UABEG00N22 | 22" X 28" | 21.30" X 27.99" | 23.58" | 37.40" | 11.243 lbs | 4.53" X 40.16" X 2.56" |
| UABEG00N24 | 24" X 36" | 23.31" X 35.98" | 25.59" | 45.28" | 13.227 lbs | 4.53" X 48.03" X 2.56" |

*W:Width H: Height D: Depth



Wood Look A Board



Wood Look A Board has aluminum profiles like standard A Boards but with wood look. It has a higher durability compared to real wood products. Standard or custom shape header is available for personalization. 23.62" x 31.50" writing area can be used with both chalk or water base chalk marker. This is the right product for customers looking for warmth of wood look and durability.

 Single packed with an easy mounting instruction sheet.

 No tool assembly.

Headers are optional accessories.

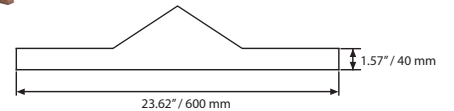
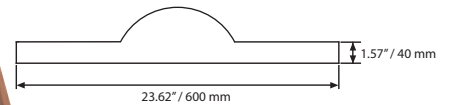
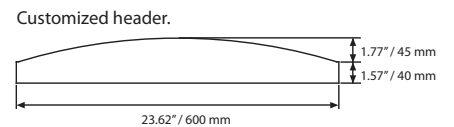
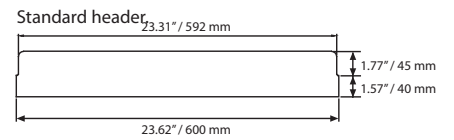
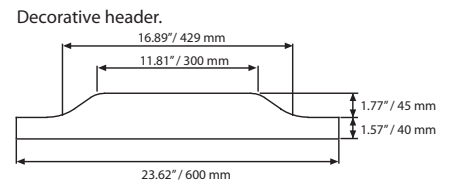

Decorative header is optional accessories.

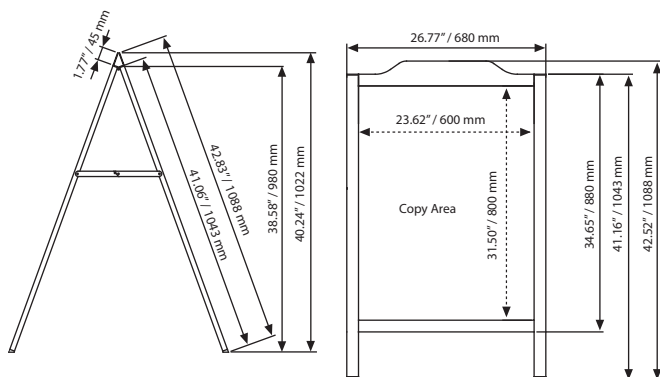
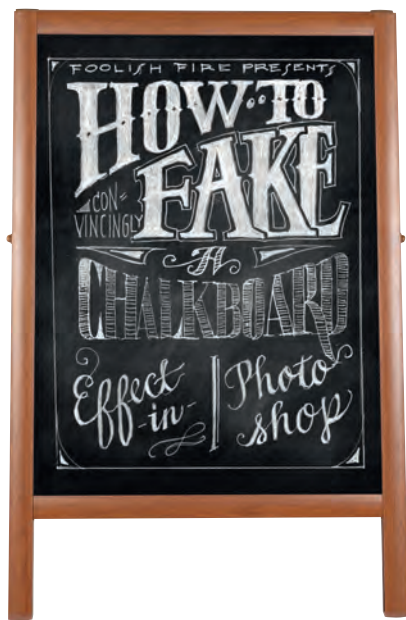

Don't forget to order
Chalkboard Marker
UYAKLM1251 - Colour Marker
UYAKLM1250 - White Marker

| MATERIAL : Aluminium | | | WEIGHT | PACKING SIZE |
|----------------------|-----------|------------------------|--------------|-------------------------|
| ARTICLE | COPY AREA | DESCRIPTION | WITH PACKING | *W X H X D |
| UAWL000022 | 22" X 28" | without header | 16.424 lbs | 28.35" X 44.49" X 2.76" |
| UAWL100024 | 24" X 36" | with decorative header | 20.106 lbs | 30.31" X 49.21" X 2.76" |



*W:Width H: Height D: Depth

Street SignPro Board



See movie at our website www.mtdisplays.com.tr



Made of durable plastic, Street SignPro Board is outdoor double sided sign frame which holds two signs in size of 24" (W) x 36"(H). Recessed sign area helps to protect poster faces. It is built with a molded-in handle for easy transport. Equipped with scissors on both sides, so SignPro does not slide and damaging sign faces. It is foldable for space saving in storage. No need to fill up with water or sand as it is already constructed with heavy materials. It is available in White, Black and Grey. Street SignPro Board is for laminating self-adhesive sticker.

Max poster thickness is 5mm.

Self-adhesive sticker is recommended with surface preparation.

Optional well nut is available. 6 well nuts recommended per sign frame, total 12 well nuts per Street SignPro Board.

Color options



Street SignPro Board - Black



Street SignPro Board - White

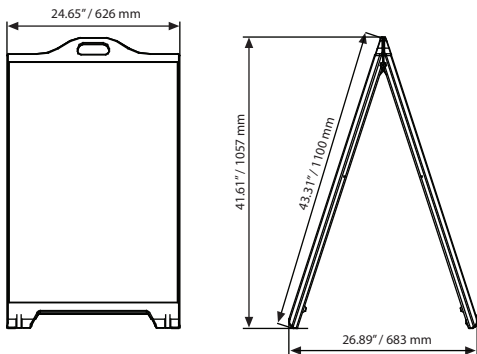

Optional well nuts
(12 Pcs)
UYSP00010X1000

Patent No: PCT/EP2017/052765

| MATERIAL : PE | | | | WEIGHT | PACKING SIZE |
|---------------|------------|-----------|-----------|--------------|-------------------------|
| WHITE | BLACK | SIZE | COPY SIZE | WITH PACKING | *W X H X D |
| UPSP310024 | UPSP320024 | 24" X 36" | 24" X 36" | 29.982 lbs | 29.13" X 49.21" X 9.84" |

*W:Width H: Height D: Depth



Street SignPro Poster with Lens



See movie at our website www.mtdisplays.com.tr

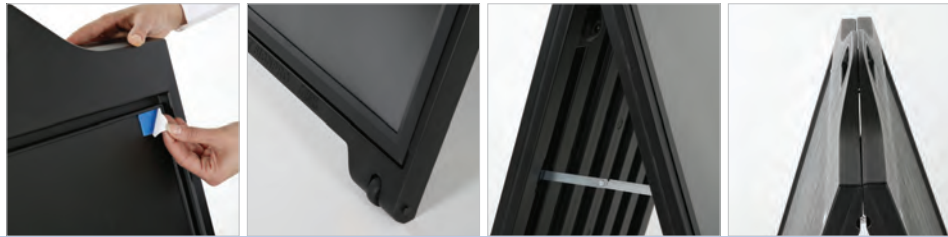

Made of durable plastic, Street SignPro Poster with Lens is outdoor double sided sign frame which holds two signs in size of 24" (W) x 36" (H). Recessed sign area helps to protect poster faces. It is built with a molded-in handle for easy transport. Equipped with scissors on both sides, so SignPro does not slide and damaging sign faces. It is foldable for space saving in storage. No need to fill up with water or sand as it is already constructed with heavy materials. It is available in White, Black and Grey. Street SignPro Frame with lens has a frame with anti-reflex graphic protection. This unique feature helps keeping the graphic in place sturdily. Frame is locked with hidden locking to avoid unnecessary access to poster.

Max poster thickness is 0,2 mm.

No tool assembly.

Color options



Street SignPro Poster with Lens- Black



Street SignPro Poster with Lens- White

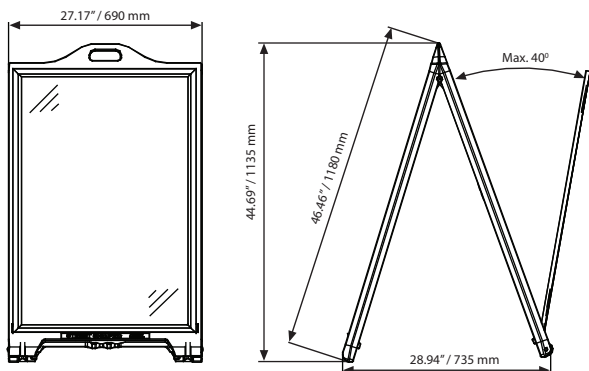

Patent No: PCT/EP2017/052765

| MATERIAL : PE | | | | WEIGHT | PACKING SIZE |
|---------------|------------|-----------|-----------------|--------------|-------------------------|
| WHITE | BLACK | SIZE | COPY SIZE | WITH PACKING | *W X H X D |
| UPSP110024 | UPSP120024 | 24" X 36" | 23.39" X 35.43" | 37.037 lbs | 29.13" X 49.21" X 9.84" |

*W:Width H: Height D: Depth



Street SignPro Poster without Lens



See movie at our website www.mtdisplays.com.tr



Made of durable plastic, Street SignPro Poster without Lens is outdoor double sided sign frame which holds two signs in size of 24" (W) x 36" (H). Recessed sign area helps to protect poster faces. It is built with a molded-in handle for easy transport. Equipped with scissors on both sides, so SignPro does not slide and damaging sign faces. It is foldable for space saving in storage. No need to fill up with water or sand as it is already constructed with heavy materials. It is available in White, Black and Grey. Street SignPro Frame without lens allows using rigid graphic. This unique feature helps keeping the graphic in place sturdily. Frame is locked with hidden locking to avoid unnecessary access to rigid poster.

Max poster thickness is 5 mm.

No tool assembly.

Color options



Street SignPro Poster without Lens - White



Street SignPro Poster without Lens - Black

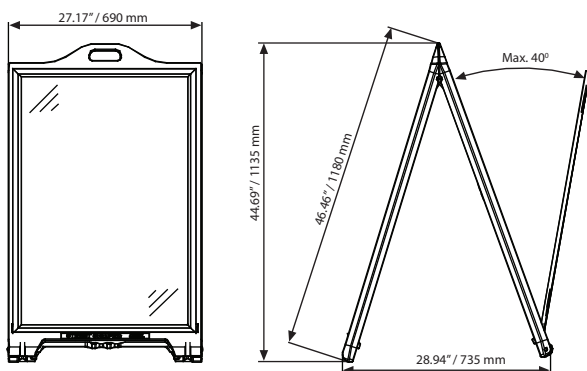

Patent No: PCT/EP2017/052765

| MATERIAL : PE | | | | WEIGHT | PACKING SIZE |
|---------------|------------|-----------|-----------------|--------------|-------------------------|
| WHITE | BLACK | SIZE | COPY SIZE | WITH PACKING | *W X H X D |
| UPSP210024 | UPSP220024 | 24" X 36" | 23.23" X 35.35" | 32.738 lbs | 29.13" X 49.21" X 9.84" |

*W:Width H: Height D: Depth



SwingPro® Plus



See movie at our website www.mtdisplays.com.tr

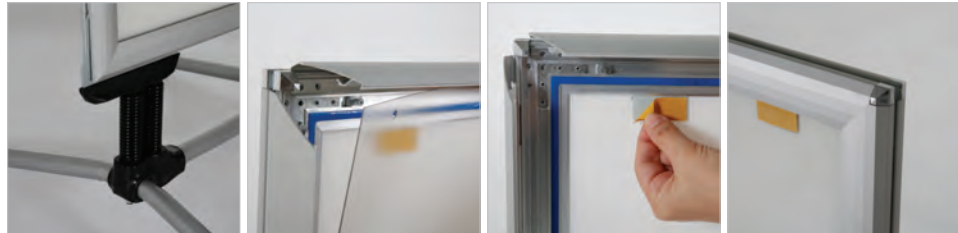

With increase performance, SwingPro® Plus is more durable against outdoor conditions. It consists of 2 main articles: frame and the base. The gasket in frame provides high vacuuming to UV resistant poster protection to keep the poster dry. PET is fixed on the top profile to help easy poster change. The poster stickers which is suitable for re-use upto 100 times are also keep the poster in place avoid sliding down the frame get wet. No sharp edges and has steel springs for flexibility. Poster use is double sided.

Base standard in dark grey color or black. Other colors are available upon request. Ground wheels in upside position enable easy movement of the product.

Please note that if the frame of SwingPro Plus and WindPro Plus is required with a "HEADER" option, then the standard articles cannot be used, please contact our sales department for the articles with a header option. Please place the poster on stickers inside the water wick around the inner frame.

Do not forget to order carry tool.

Assembly in 65-75 seconds.

One top goes with 2 different bases.

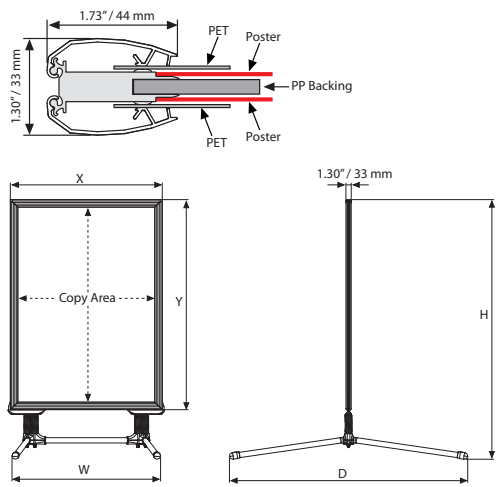

| STEEL BASE : Silver anodised aluminium | | | | | | | WEIGHT | PACKING SIZE |
|--|------------|--------|---------|--------|--------|--------|--------------|------------------------|
| SILVER | BLACK | SIZE | FOR | H | W | D | WITH PACKING | *W X H X D |
| UTSM001000 | UTSM001010 | 36.22" | 20"X30" | 44.84" | 27.17" | 36.22" | 7.716 lbs | 8.66" X 38.19" X 1.85" |
| | | | 22"X28" | 42.83" | 27.17" | 36.22" | 7.716 lbs | 8.66" X 38.19" X 1.85" |
| UTSM002000 | UTSM002010 | 42.13" | 24"X36" | 50.87" | 27.17" | 42.13" | 8.818 lbs | 8.66" X 46.46" X 1.85" |
| UTSM003000 | UTSM003010 | 49.61" | 30"X40" | 54.21" | 35.04" | 49.61" | 10.141 lbs | 8.66" X 51.57" X 1.85" |
| | | | FO | 62.09" | 35.04" | 55.91" | 10.141 lbs | 8.66" X 51.57" X 1.85" |

| FRAME : Powder coated steel | | | | | | WEIGHT | PACKING SIZE |
|-----------------------------|------------|-----------------|-----------|-----------------|--|--------------|-------------------------|
| SILVER | BLACK | EXTERNAL (x-y) | POSTER | COPY | | WITH PACKING | *W X H X D |
| USWPP00N22 | USWPP00N22 | 25.03" X 31.03" | 22" X 28" | 21.53" X 27.53" | | 17.526 lbs | 26.18" X 40.55" X 1.57" |
| USWPP00N23 | USWPP00N23 | 23.03" X 33.03" | 20" X 30" | 19.53" X 29.53" | | 17.526 lbs | 24.21" X 43.31" X 1.57" |
| USWPP00N24 | USWPP00N24 | 27.03" X 39.03" | 24" X 36" | 23.53" X 35.53" | | 19.731 lbs | 27.95" X 48.82" X 1.57" |
| USWPP00N34 | USWPP00N34 | 33.03" X 43.03" | 30" X 40" | 29.53" X 39.53" | | 24.912 lbs | 34.45" X 53.15" X 1.57" |
| USWPP00NFO | USWPP00NFO | 36.14" X 55.04" | FO | 32.64" X 51.54" | | 28.660 lbs | 34.65" X 59.06" X 1.57" |

*W:Width H: Height D: Depth



WindPro® Plus



See movie at our website www.mtdisplays.com.tr

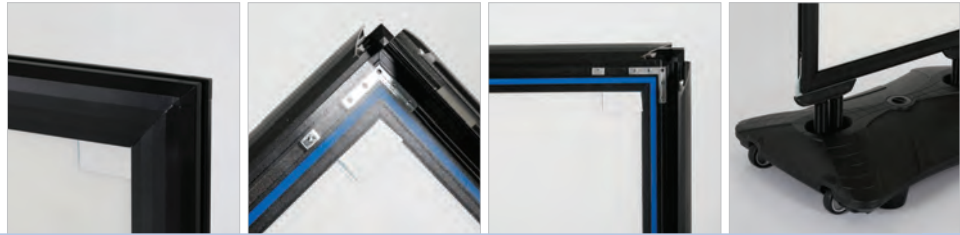

With increase performance, WindPro® Plus is more durable against outdoor conditions. It consists of 2 main articles: frame and the base. The gasket in frame provides high vacuuming to UV resistant poster protection to keep the poster dry. PET is fixed on the top profile to help easy poster change. The poster stickers which is suitable for re-use upto 100 times are also keep the poster in place avoid sliding down the frame get wet. No sharp edges and has steel springs for flexibility. Poster use is double sided.

Base standard in dark grey color or black. Other colors are available upon request. Ground wheels in upside position enable easy movement of the product.

Please note that if the frame of SwingPro Plus and WindPro Plus is required with a "HEADER" option, then the standard articles cannot be used, please contact our sales department for the articles with a header option. Please place the poster on stickers inside the water wick around the inner frame.

Do not forget to order carry tool.

Assembly in 65-75 seconds.

UYUP480945
Optional
carry tool.



One top goes with 2 different bases.

1.30" / 33 mm depth

1.73" / 44 mm design profile



Newtech Waterbase



Strong PP backing

Stell Base

Patent No: OHIM DM/084 128

Snap open

Safe corner



Clear cover hanger



Adhesive poster tape

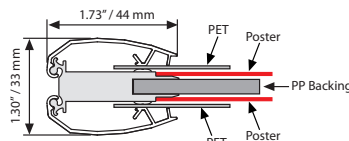
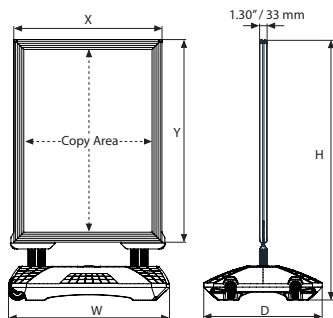

| NEWTECH WATER BASE: HLDPE | | | | | | | WEIGHT | PACKING SIZE |
|---------------------------|------------|-----------------|---------|--------|--------|--------|--------------|-------------------------|
| SILVER | BLACK | SIZE | FOR | H | W | D | WITH PACKING | *W X H X D |
| UTWM003000 | UTWM003010 | 28.35" X 20.87" | 20"X30" | 42.87" | 28.35" | 20.87" | 9.876 lbs | 21.85" X 29.53" X 7.01" |
| | | | 22"X28" | 40.87" | 28.35" | 20.87" | | |
| | | | 24"X36" | 48.90" | 28.35" | 20.87" | | |
| UTWM004000 | UTWM004010 | 35.43" X 24.80" | 30"X40" | 52.87" | 35.43" | 24.80" | 15.101 lbs | 23.82" X 36.61" X 7.01" |
| | | | F0 | 48.90" | 35.43" | 24.80" | | |

| FRAME : Powder coated steel | | | | | | WEIGHT | PACKING SIZE |
|-----------------------------|------------|-----------------|-----------|-----------------|--|--------------|-------------------------|
| SILVER | BLACK | EXTERNAL (x-y) | POSTER | COPY | | WITH PACKING | *W X H X D |
| USWPP00N22 | USWPP00N22 | 25.03" X 31.03" | 22" X 28" | 21.53" X 27.53" | | 17.526 lbs | 26.18" X 40.55" X 1.57" |
| USWPP00N23 | USWPP00N23 | 23.03" X 33.03" | 20" X 30" | 19.53" X 29.53" | | 17.526 lbs | 24.21" X 43.31" X 1.57" |
| USWPP00N24 | USWPP00N24 | 27.03" X 39.03" | 24" X 36" | 23.53" X 35.53" | | 19.731 lbs | 27.95" X 48.82" X 1.57" |
| USWPP00N34 | USWPP00N34 | 33.03" X 43.03" | 30" X 40" | 29.53" X 39.53" | | 24.912 lbs | 34.45" X 53.15" X 1.57" |
| USWPP00NFO | USWPP00NFO | 36.14" X 55.04" | F0 | 32.64" X 51.54" | | 28.660 lbs | 34.65" X 59.06" X 1.57" |

*W:Width H: Height D: Depth



SwingPro® Lite



See movie at our website www.mtdisplays.com.tr

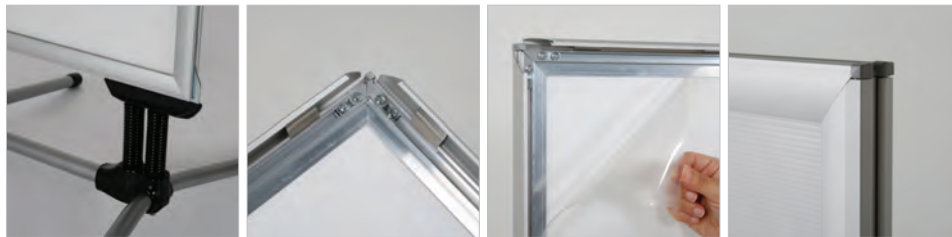

SwingPro® Lite is heavy and robust waterbase pavement sign for outdoor. It consists of 2 main articles: frame and the base. No sharp edges and has steel springs for flexibility. Poster use is double sided. Recommended to use film posters.

Base standard in dark grey color or black. Other colors are available upon request. Ground wheels in upside position enable easy movement of the product.

Please note that if the frame of SwingPro Plus and WindPro Plus is required with a "HEADER" option, then the standard articles cannot be used, please contact our sales department for the articles with a header option. Please place the poster on stickers inside the water wick around the inner frame.

Do not forget to order carry tool.

Assembly in 65-75 seconds.

One top goes with 2 different bases.

Strong PP backing

1.10" / 28 mm depth

1.30" / 33 mm design profile

WEATHERPROOF IP56

WIND RESISTANT

Newtech Waterbase

Stell Base

Safe corner

Patent No: OHIM DM/084 128

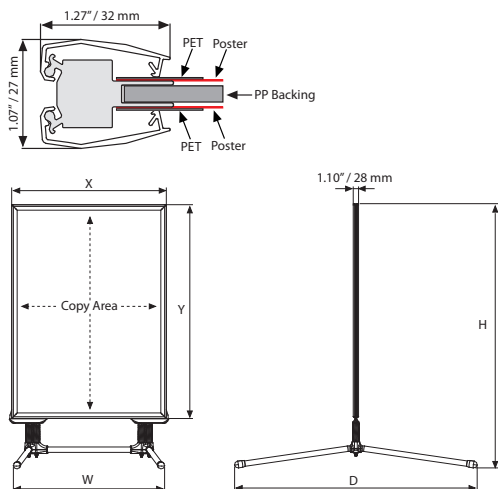

| STEEL BASE : Silver anodised aluminium | | | | | | | WEIGHT | PACKING SIZE |
|--|------------|--------|-----------|--------|--------|--------|--------------|------------------------|
| SILVER | BLACK | SIZE | FOR | H | W | D | WITH PACKING | *W X H X D |
| UTSM001000 | UTSM001010 | 36.22" | 22" X 28" | 41.30" | 27.17" | 36.22" | 7.716 lbs | 8.66" X 38.19" X 1.85" |
| UTSM002000 | UTSM002010 | 42.13" | 24" X 36" | 49.33" | 27.17" | 42.13" | 8.818 lbs | 8.66" X 46.46" X 1.85" |
| UTSM003000 | UTSM003010 | 49.61" | 28" X 44" | 57.28" | 35.04" | 49.61" | 10.141 lbs | 8.66" X 51.57" X 1.85" |
| | | | 30" X 40" | 53.31" | 35.04" | 49.61" | 10.141 lbs | 8.66" X 51.57" X 1.85" |

| FRAME : Silver anodised aluminium | | | | | | WEIGHT | PACKING SIZE |
|-----------------------------------|------------|-----------------|-----------|-----------------|--|--------------|-------------------------|
| SILVER | BLACK | EXTERNAL (x-y) | POSTER | COPY | | WITH PACKING | *W X H X D |
| USWPL00N22 | USWPL00B22 | 23.50" X 29.49" | 22" X 28" | 20.98" X 26.98" | | 12.015 lbs | 25.39" X 39.76" X 1.38" |
| USWPL00N24 | USWPL00B24 | 25.51" X 37.52" | 24" X 36" | 22.98" X 34.98" | | 14.418 lbs | 27.17" X 47.83" X 1.38" |
| USWPL00N34 | USWPL00B34 | 31.50" X 41.50" | 30" X 40" | 28.98" X 38.98" | | 18.739 lbs | 33.27" X 51.77" X 1.38" |
| USWPL00N84 | USWPL00B84 | 29.50" X 45.50" | 28" X 44" | 26.98" X 42.98" | | 19.841 lbs | 31.30" X 55.71" X 1.38" |

*W:Width H: Height D: Depth



WindPro® Lite



See movie at our website www.mtdisplays.com.tr



WindPro® Lite is heavy and robust waterbase pavement sign for outdoor. It consists of 2 main articles: frame and the base. No sharp edges and has steel springs for flexibility. Poster use is double sided. Recommended to use film posters.

Base standard in dark grey color or black. Other colors are available upon request. Ground wheels in upside position enable easy movement of the product.

Please note that if the frame of SwingPro Plus and WindPro Plus is required with a "HEADER" option, then the standard articles cannot be used, please contact our sales department for the articles with a header option. Please place the poster on stickers inside the water wick around the inner frame.

Do not forget to order carry tool.

Assembly in 65-75 seconds.

One top goes with 2 different bases.

Strong PP backing

UYUP480945 Optional carry tool.

Patent No: OHIM DM/084 128

Snap open

Safe corner

1.30" / 33 mm design profile

WEATHERPROOF IP56

WIND RESISTANT

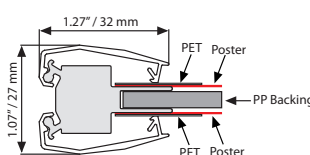
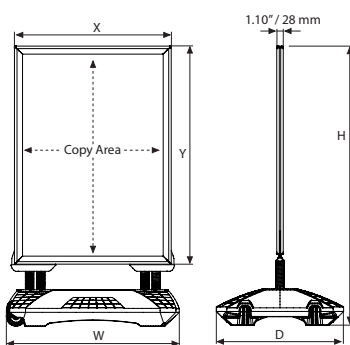

| NEWTECH WATERBASE : HLDPE | | | | | | | WEIGHT | PACKING SIZE |
|---------------------------|------------|-----------------|-----------|--------|--------|--------|--------------|-------------------------|
| SILVER | BLACK | SIZE | FOR | H | W | D | WITH PACKING | *W X H X D |
| UTWM003000 | UTWM003010 | 28.35" X 20.87" | 22" X 28" | 39.33" | 28.35" | 20.87" | 9.876 lbs | 21.85" X 29.53" X 7.01" |
| | | | 24" X 36" | 47.36" | 28.35" | 20.87" | | |
| UTWM004000 | UTWM004010 | 35.43" X 24.80" | 28" X 44" | 55.31" | 35.43" | 24.80" | 15.101 lbs | 23.82" X 36.61" X 7.01" |
| | | | 30" X 40" | 51.34" | 35.43" | 24.80" | | |

| FRAME : Silver anodised aluminium | | | | | | WEIGHT | PACKING SIZE |
|-----------------------------------|------------|-----------------|-----------|-----------------|--|--------------|-------------------------|
| SILVER | BLACK | EXTERNAL (x-y) | POSTER | COPY | | WITH PACKING | *W X H X D |
| USWPL00N22 | USWPL00B22 | 23.50" X 29.49" | 22" X 28" | 20.98" X 26.98" | | 12.015 lbs | 25.39" X 39.76" X 1.38" |
| USWPL00N24 | USWPL00B24 | 25.51" X 37.52" | 24" X 36" | 22.98" X 34.98" | | 14.418 lbs | 27.17" X 47.83" X 1.38" |
| USWPL00N34 | USWPL00B34 | 31.50" X 41.50" | 30" X 40" | 28.98" X 38.98" | | 18.739 lbs | 33.27" X 51.77" X 1.38" |
| USWPL00N84 | USWPL00B84 | 29.50" X 45.50" | 28" X 44" | 26.98" X 42.98" | | 19.841 lbs | 31.30" X 55.71" X 1.38" |

*W:Width H: Height D: Depth



BannerPro



Reasonably priced and practical BannerPro is suitable for outdoor use. Solid finish on the iron profiles provide elegant image to product. O rings included in the product.

Suitable for windy outdoor conditions. Packed unassembled.

Stain free outdoor powder coating.

Available in Silver and Black as standard.

Color options:



UYUP480945
Optional carry tool.
Pulling force 13,227"-17,636" max.

Newtech Waterbase

Stell Base

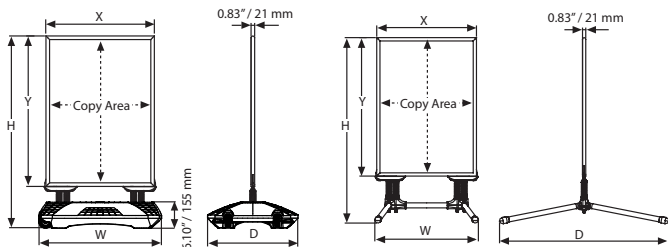

| FRAME : Powder coated aluminium | | | | WEIGHT | PACKING SIZE |
|---------------------------------|------------|-----------------|-------------|-----------------|------------------------------------|
| SILVER | BLACK | EXTERNAL (x-y) | POSTER COPY | WITH PACKING | *W X H X D |
| UBPON0024 | UBPOB00024 | 25.73" X 37.73" | 24" X 36" | 24.08" X 36.08" | 11.287 lbs 28.35" X 50" X 1.85" |
| UBPON0034 | UBPOB00034 | 31.73" X 41.73" | 30" X 40" | 30.08" X 40.08" | 16.358 lbs 35.04" X 53.94" X 1.85" |

| STEEL BASE : Powder coated aluminium | | | | | | WEIGHT | PACKING SIZE |
|--------------------------------------|------------|-----------|--------|--------|--------|--------------|------------------------|
| SILVER | BLACK | FOR | H | W | D | WITH PACKING | *W X H X D |
| UTSM002000 | UTSM002010 | 24" X 36" | 50.63" | 27.17" | 42.13" | 12.345 lbs | 8.66" X 46.46" X 1.85" |
| UTSM003000 | UTSM003010 | 30" X 40" | 54.65" | 35.04" | 49.61" | 10.141 lbs | 8.66" X 51.57" X 1.85" |

| NEWTECH WATERBASE : HDPE | | | | | | WEIGHT | PACKING SIZE |
|--------------------------|------------|-----------|--------|--------|--------|--------------|-------------------------|
| SILVER | BLACK | FOR | H | W | D | WITH PACKING | *W X H X D |
| UTWM003000 | UTWM003010 | 24" X 36" | 48.46" | 28.35" | 20.87" | 9.876 lbs | 21.85" X 29.53" X 7.01" |
| UTWM004000 | UTWM004010 | 30" X 40" | 52.48" | 35.43" | 24.80" | 15.101 lbs | 23.82" X 36.61" X 7.01" |

*W:Width H: Height D: Depth



Slide-in SwingPro® & WindPro®



Top opening Slide-in WindPro® is a well designed outdoor product. Poster is secured in the lockable frame and stands firm between the cover and backing. Safe corners of the frame complies health and safety regulations. The springs stabilize the poster and frame in outdoor conditions.

- Single packed in 2 boxes with an easy mounting instruction sheet.
- Bottom profile of sandwich slide-in panel provide easy application.
- Heavy long feet on the base provide stability.

Color options:
 Silver Black

UYUP480945
Optional carry tool.
Pulling force
13,227" - 17,636" max.



One top goes with 2 different bases.

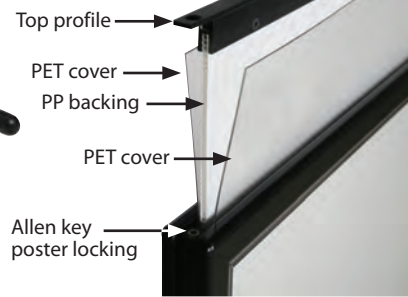
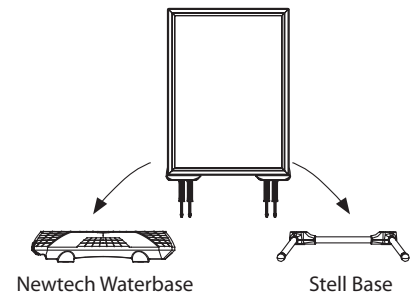

Patent No: OHIM DM/084 128

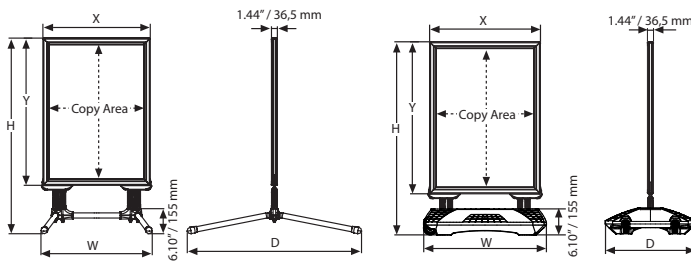

| FRAME : Silver anodised aluminium | | | | | WEIGHT | PACKING SIZE |
|-----------------------------------|------------|-----------------|-----------|-----------------|--------------|-------------------------|
| SILVER | BLACK | EXTERNAL (x-y) | POSTER | COPY | WITH PACKING | *W X H X D |
| USWS000N22 | USWS000B28 | 24.84" X 30.83" | 22" X 28" | 21.69" X 27.68" | 17.868 lbs | 26.77" X 41.34" X 1.85" |
| USWS000N24 | USWS000B24 | 26.85" X 38.82" | 24" X 36" | 23.70" X 35.67" | 21.142 lbs | 29.53" X 50" X 1.85" |
| USWS000N74 | USWS000B74 | 29.84" X 42.83" | 27" X 40" | 26.69" X 39.69" | 24.890 lbs | 32.28" X 52.76" X 1.85" |

| STEEL BASE : Powder coated aluminium | | | | | | | WEIGHT | PACKING SIZE |
|--------------------------------------|------------|-----------|--------|--------|--------|--------------|------------------------|--------------|
| SILVER | BLACK | FOR | H | W | D | WITH PACKING | *W X H X D | |
| UTSM002000 | UTSM002010 | 22" X 28" | 42.64" | 27.17" | 42.13" | 8.818 lbs | 8.66" X 46.46" X 1.85" | |
| UTSM002000 | UTSM002010 | 24" X 36" | 50.63" | 27.17" | 42.13" | 12.345 lbs | 8.66" X 46.46" X 1.85" | |
| UTSM003000 | UTSM003010 | 30" X 40" | 54.65" | 35.04" | 49.61" | 10.141 lbs | 8.66" X 51.57" X 1.85" | |

| NEWTECH WATERBASE : HLDPE | | | | | | | WEIGHT | PACKING SIZE |
|---------------------------|------------|-----------|--------|--------|--------|--------------|-------------------------|--------------|
| SILVER | BLACK | FOR | H | W | D | WITH PACKING | *W X H X D | |
| UTWM003000 | UTWM003010 | 22" X 28" | 40.47" | 28.35" | 20.87" | 9.876 lbs | 21.85" X 29.53" X 7.01" | |
| UTWM003000 | UTWM003010 | 24" X 36" | 48.46" | 28.35" | 20.87" | 9.876 lbs | 21.85" X 29.53" X 7.01" | |
| UTWM004000 | UTWM004010 | 30" X 40" | 52.48" | 35.43" | 24.80" | 15.101 lbs | 23.82" X 36.61" X 7.01" | |

*W:Width H: Height D: Depth



Illuminated WindPro® with LED



See movie at our website www.mtdisplays.com.tr



MT Displays' innovative and user friendly Illuminated WindPro with LED is an eye-catcher product will attract consumers to message and place. Energy saving and bright modes are applied with switch easily. Life PO4 battery which provides high power on low weight is hidden on the base to give a neat look at Illuminated WindPro. Lockable UV polycarbonate covers and locked battery compartment keep the poster and battery in safe. The upper frame is weatherproof non-snap body, has elastic rope that hinges the cover and can be secured via 12 locks. The installation of visual is very simple by inserting the visual upwards into metal poster clips.

Charging unit included. Battery can't be charged in the product. Chrome coated zamak mitred look and yet soft finish corners.

Battery will be shipped at full charge capacity see digital LED indication on battery to recharge.



A unique solution as a Pavement Sign with battery

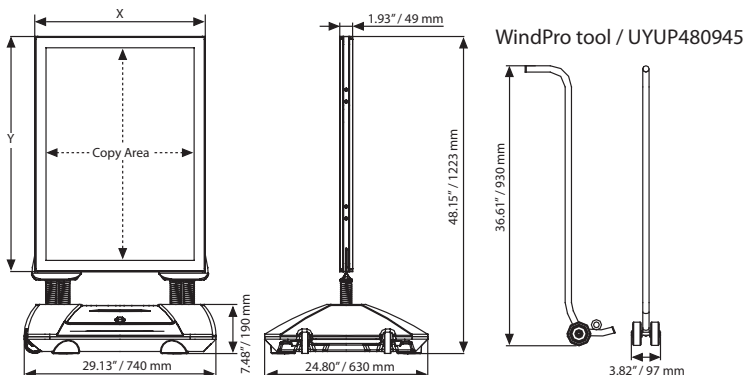

| MATERIAL : Silver & black powder coated frame & waterbase | | | | WEIGHT | PACKING SIZE |
|---|-----------------|-----------------|-----------------|--------------|--|
| ARTICLE | EXTERNAL (x-y) | POSTER | COPY | WITH PACKING | *W X H X D |
| USWL000A1 | 25.91" X 35.71" | 23.39" X 33.11" | 22.52" X 32.32" | 77.382 lbs | 33.07" X 55.91" X 4.41" 26.77" X 30.71" X 7.80" |



*W:Width H: Height D: Depth

Eco Swingmaster



See movie at our website www.mtdisplays.com.tr

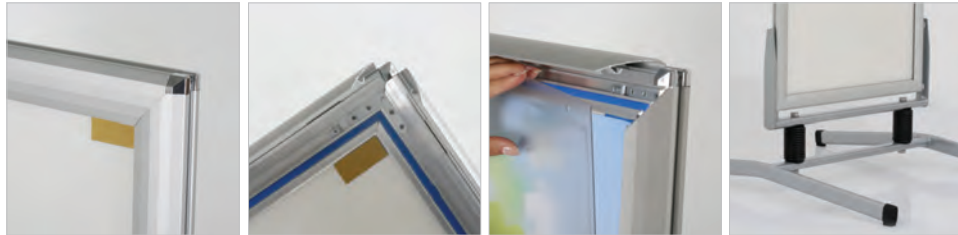

Various sizes are available all with safe mitred corners. Its round corners do not have sharp edges. After the closure of the side profiles, the rubber seal inside the swingmaster in addition with over size PET makes the product waterproof. The easy-to-open snap frame includes an anti-reflex cover suitable for external use when equipped with a water wick. Product is double sided. The steel springs provide the flexibility to ensure stability.

- The product is packed unassembled with an easy mounting instruction sheet & fixing set.
- Suitable for windy outdoor conditions. Suitable for rainy conditions, the rubber seal around the frame protect the poster within. Round corners raise the safety level on the pavement.
- Heavy long feet on the base provide stability.
- 2 packs. See info chart for pack sizes.

IMPROVED FOR 2018

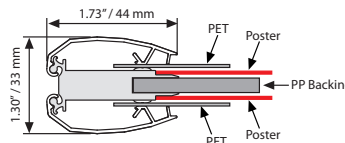
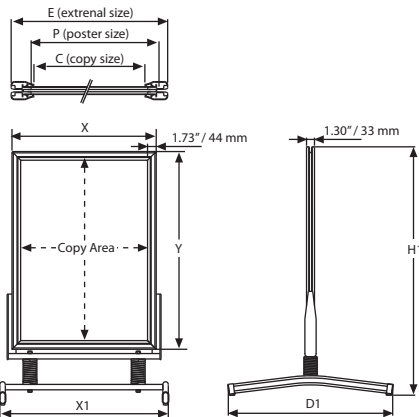

| MATERIAL : Silver anodised aluminium | | | | | WEIGHT | PACKING SIZE | LEG | | |
|--------------------------------------|-----------------|-----------|-----------------|--------|--------------|-------------------------|--------|--------|---------|
| ARTICLE | EXTERNAL (x-y) | POSTER | COPY | H1 | WITH PACKING | *W X H X D | X1 | D1 | SPRINGS |
| UESM000N22 | 25.03" X 31.03" | 22" X 28" | 21.53" X 27.53" | 40.94" | 27.116 lbs | 29.72" X 36.81" X 4.13" | 25.28" | 35.43" | 2 |
| UESM000N23 | 23.03" X 33.03" | 20" X 30" | 19.53" X 29.53" | 42.32" | 27.116 lbs | 27.95" X 38.98" X 4.13" | 25.28" | 35.43" | 2 |
| UESM000N24 | 27.03" X 39.03" | 24" X 36" | 23.53" X 35.53" | 49.02" | 34.171 lbs | 27.95" X 41.34" X 4.13" | 28.66" | 41.34" | 2 |
| UESM000N34 | 33.03" X 43.03" | 30" X 40" | 29.53" X 39.53" | 53.35" | 41.887 lbs | 965" X 50.79" X 4.13" | 35.28" | 48.82" | 2 |
| UESM000N46 | 43.03" X 63.03" | 40" X 60" | 39.53" X 59.53" | 74.61" | 57.320 lbs | 48.03" X 71.06" X 4.13" | 45.28" | 62.99" | 2 |

*W:Width H: Height D: Depth



Eco Waterbase Wind Sign



See movie at our website www.mtdisplays.com.tr



Various sizes are available all with safe mitred corners. Its round corners do not have sharp edges. After the closure of the side profiles, the rubber seal in addition with over size PET makes the product waterproof. The easy-to-open snap frame includes an anti-reflex cover. The steel springs provide the flexibility to ensure stability. The wheels ensure the movement of the unit. Product is double sided.

Each base comes with industrial salt to prevent freezing in winter conditions. Each product comes unassembled with an easy-to-understand instruction sheet & fixing set.

Suitable for rainy & windy conditions, protects the poster within. Ground wheels in upside position facilitate movement of the product. Round corners raise the safety level on the pavement. The standard color of is metallic grey while other colors are available upon request.

Heavy base provides stability.

IMPROVED FOR 2018

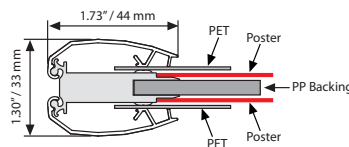
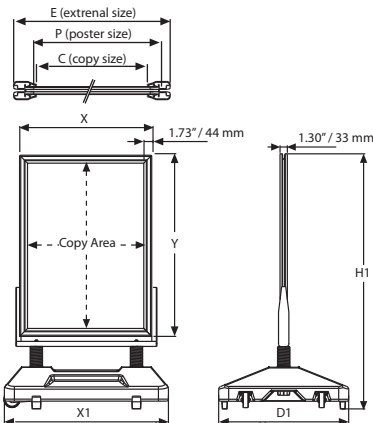

MATERIAL : Silver anodised aluminium

| ARTICLE | EXTERNAL (x-y) | POSTER | COPY | H1 | X1 | D1 |
|------------|-----------------|-----------|-----------------|--------|--------|--------|
| UEWM000N22 | 25.03" X 31.03" | 22" X 28" | 21.53" X 27.53" | 45.08" | 27.56" | 21.35" |
| UEWM000N23 | 23.03" X 33.03" | 20" X 30" | 19.53" X 29.53" | 46.85" | 27.56" | 21.65" |
| UEWM000N24 | 27.03" X 39.03" | 24" X 36" | 23.53" X 35.53" | 53.35" | 32.28" | 25.59" |
| UEWM000N34 | 33.03" X 43.03" | 30" X 40" | 29.53" X 39.53" | 57.28" | 32.28" | 25.59" |
| UEWM000N46 | 43.03" X 63.03" | 40" X 60" | 39.53" X 59.53" | 74.02" | 39.37" | 29.53" |

| MAIN BODY | | | WATER BASE | |
|--------------|-------------------------|--------------|-------------------------|--|
| WEIGHT | PACKING SIZE | WEIGHT | PACKING SIZE | |
| WITH PACKING | *W X H X D | WITH PACKING | *W X H X D | |
| 17.526 lbs | 26.18" X 40.55" X 1.57" | 17.857 lbs | 22.44" X 28.35" X 9.45" | |
| 17.526 lbs | 24.21" X 43.31" X 1.57" | 17.857 lbs | 22.44" X 28.35" X 9.45" | |
| 19.731 lbs | 27.95" X 48.82" X 1.57" | 25.353 lbs | 33.07" X 26.38" X 9.45" | |
| 24.912 lbs | 34.45" X 53.15" X 1.57" | 25.353 lbs | 33.07" X 26.38" X 9.45" | |
| 37.478 lbs | 39.96" X 67.52" X 1.57" | 30.864 lbs | 40.16" X 30.31" X 9.45" | |



*W:Width H: Height D: Depth

Waterbase Wind Sign Base

Small Base

- Used in 20"x30" sizes
- Weight when empty is 17.636 lbs.
- Weight when filled with water is 79.366 lbs
- Small base can take in 28 liters of water.

Medium Base

- Used in 30"x40" size.
- Weight when empty is 19.841 lbs.
- Weight when filled with water is 101.412 lbs.
- Medium base can take in 37 liters of water.

Large Base

- Used in 40"x60" size.
- Weight when empty is 33.069 lbs
- Weight when filled with water is 152.118 lbs.
- Large base can take in 54 liters of water.

The weights are approximate values per each base.

Small Base

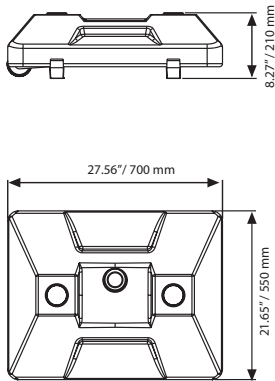

Medium Base

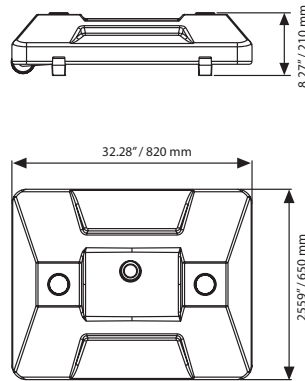

Large Base

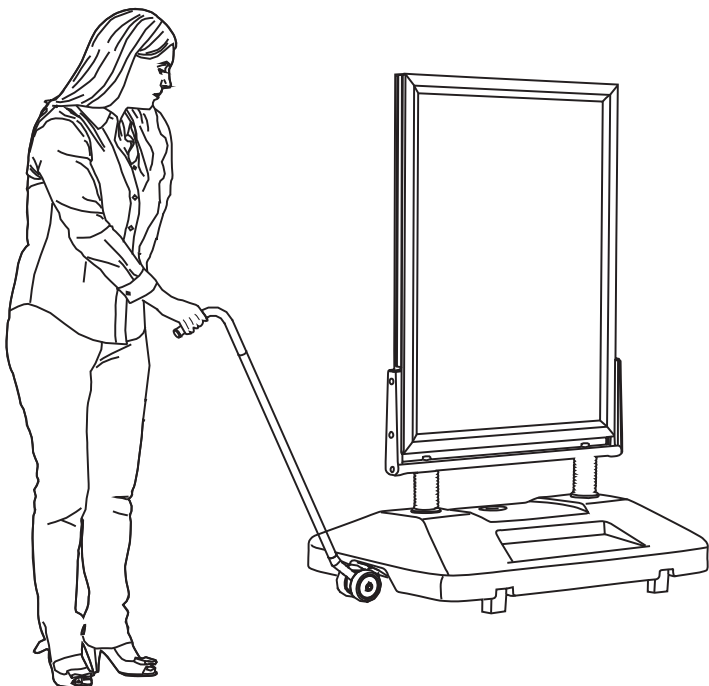
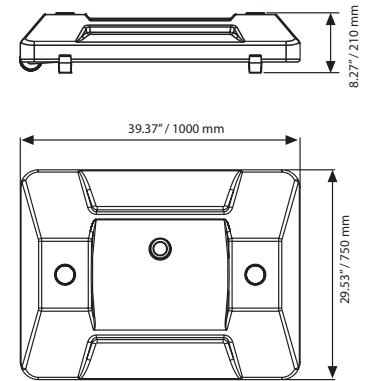

| WIND SIGN BASE | | | WEIGHT | PACKING SIZE |
|----------------|-------------|---------|--------------|-------------------------|
| ARTICLE | DESCRIPTION | SPRINGS | WITH PACKING | *W X H X D |
| UYUP406820 | Small base | 2 | 17.857 lbs | 22.44" X 28.35" X 9.45" |
| UYUP406810 | Medium Base | 2 | 25.353 lbs | 33.07" X 26.38" X 9.45" |
| UYUP406840 | Large Base | 2 | 30.864 lbs | 40.16" X 30.31" X 9.45" |

*W:Width H: Height D: Depth

Pavement Sign Headers



SwingPro® Lite Header
WindPro® Lite Header

SwingPro® Plus Header
WindPro® Plus Header

Eco Swingmaster Header
Eco Waterbase Wind Sign Header

A Board Header
Eco Aboard Header
A Board with Safe Corner Header



SwingPro® Lite



SwingPro® Plus



Eco Swingmaster



A Board



WindPro® Lite



WindPro® Plus



Eco Waterbase Wind Sign

Header / Topchild

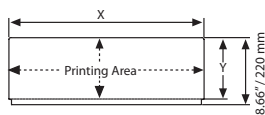

| HEADER: 0.12" PVC Foam | | | | WEIGHT |
|------------------------|-----------|---------------------|--------------|--------|
| ARTICLE | SIZE | PRINTING AREA (x-y) | WITH PACKING | |
| UYFT004022 | 22" X 28" | 23.50" X 7.87" | 0.551 lbs | |
| UYFT004024 | 24" X 36" | 25.51" X 7.87" | 0.595 lbs | |
| UYFT004034 | 30" X 40" | 31.50" X 7.87" | 0.738 lbs | |
| UYFT004084 | 28" X 44" | 29.53" X 7.87" | 0.683 lbs | |

Header / Topchild

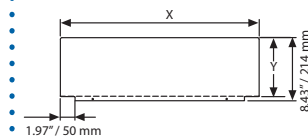

| HEADER: 0.12" PVC Foam | | | | WEIGHT |
|------------------------|-----------|---------------------|--------------|--------|
| ARTICLE | SIZE | PRINTING AREA (x-y) | WITH PACKING | |
| UYFT005022 | 22" X 28" | 25" X 7.87" | 0.551 lbs | |
| UYFT005023 | 20" X 30" | 23.03" X 7.87" | 0.507 lbs | |
| UYFT005024 | 24" X 36" | 27.05" X 7.87" | 0.595 lbs | |
| UYFT005034 | 30" X 40" | 33.03" X 7.87" | 0.738 lbs | |
| UYFT0050F0 | F0 | 34.53" X 7.87" | 0.771 lbs | |

Header / Topchild

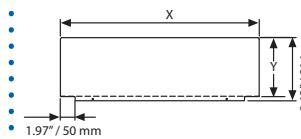

| HEADER: 0.12" PVC Foam | | | | WEIGHT |
|------------------------|-----------|---------------------|--------------|--------|
| ARTICLE | SIZE | PRINTING AREA (x-y) | WITH PACKING | |
| UYFT005022 | 22" X 28" | 25" X 7.87" | 0.551 lbs | |
| UYFT005023 | 20" X 30" | 23.03" X 7.87" | 0.507 lbs | |
| UYFT005024 | 24" X 36" | 27.05" X 7.87" | 0.595 lbs | |
| UYFT005034 | 30" X 40" | 33.03" X 7.87" | 0.738 lbs | |
| UYFT005046 | 40" X 60" | 43.03" X 7.87" | 0.992 lbs | |

Header / Topchild

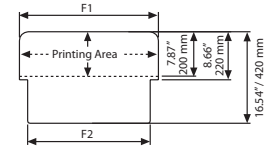

| HEADER FOR 0.16" PVC Foam | | | WEIGHT |
|---------------------------|--------|--------|--------------|
| ARTICLE | F1 | F2 | WITH PACKING |
| UYFT000022 | 23.54" | 20.47" | 1.543 lbs |
| UYFT000023 | 21.57" | 18.50" | 1.763 lbs |
| UYFT000024 | 25.59" | 22.52" | 2.645 lbs |
| UYFT000034 | 31.57" | 28.50" | 3.196 lbs |

| HEADER FOR 1" PVC Foam | | | WEIGHT |
|------------------------|--------|--------|--------------|
| ARTICLE | F1 | F2 | WITH PACKING |
| UYFT250022 | 23.15" | 16.54" | 0.881 lbs |
| UYFT250024 | 25.16" | 16.54" | 1.234 lbs |

Header Holder / Topchild Halter

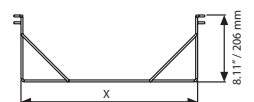

| HEADER HOLDER | | WEIGHT |
|---------------|--------|--------------|
| ARTICLE | X | WITH PACKING |
| UYTT000022 | 17.44" | 1.609 lbs |
| UYTT000023 | 19.41" | 1.653 lbs |
| UYTT000024 | 23.43" | 1.741 lbs |
| UYTT000034 | 29.41" | 1.918 lbs |

| HEADER HOLDER | | WEIGHT |
|---------------|--------|--------------|
| ARTICLE | X | WITH PACKING |
| UYTT250022 | 20.12" | 1.719 lbs |
| UYTT250024 | 22.36" | 1.807 lbs |

*W:Width H: Height D: Depth

Al Maki



See movie at our website www.mtdisplays.com.tr







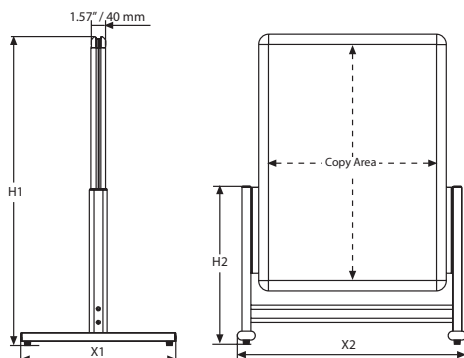

A double-sided customer stopper, practical to change the poster within. 22"X28" size available. 1.26" profile, snap frame. Round or mitred corner options.

 Single packed with an easy-to-understand instruction sheet

 Heavy back panel provides stability. No tool assembly.



| MATERIAL : Silver anodised aluminium | | | | | | WEIGHT | PACKING SIZE |
|--------------------------------------|-----------|--------|--------|--------|--------|--------------|-------------------------|
| ARTICLE | POSTER | X1 | X2 | H1 | H2 | WITH PACKING | *W X H X D |
| UAM321CN22 | 22" X 28" | 24.41" | 28.35" | 34.65" | 18.11" | 13.668 lbs | 25.98" X 33.46" X 2.76" |

       *W:Width H: Height D: Depth



Rectangular Iron A Board



See movie at our website www.mtdisplays.com.tr



Stable & heavy pavement sign, used from both sides. There is a magnetic cover placed over the poster. Suitable for highly frequented public areas.

-  Product is packed single & assembled.
-  No tool assembly. Finger hole allows for an easy change of the poster.
-  Heavy steel feet provide stability. Backing tray is galvanized as a standard product, powder coating is optional. Comes in black, silver, white color options.

Color options:

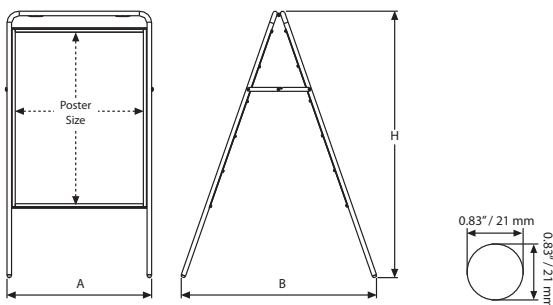

Header / Topchild

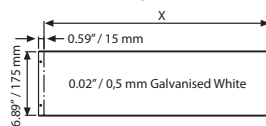

| MATERIAL : Iron A Board | | | | | | | WEIGHT | PACKING SIZE |
|-------------------------|-----------|--------|--------|--------|--------|----------------|--------------|-------------------------|
| ARTICLE | POSTER | A | B | H | X | DESCRIPTION | WITH PACKING | *W X H X D |
| UABD211N23 | 20" X 30" | 22.83" | 35.43" | 48.43" | 21.18" | With header | 29.530 lbs | 24.41" X 53.15" X 3.15" |
| UABD210N23 | 20" X 30" | 22.83" | 35.43" | 48.43" | - | Without header | 27.888 lbs | 24.41" X 53.15" X 3.15" |

*W:Width H: Height D: Depth



Magnetic Iron A Board



Stable & heavy pavement sign, used from both sides. There is a magnetic cover placed over the poster. The poster sizes are 22"x28", 20"x30", 24"x36". Other sizes are available upon request. Suitable for highly frequented public areas.

Product is packed single & assembled.

No tool assembly. Finger hole allows for an easy change of the poster. Header is standard supplied and provides space for corporate logo.

Heavy steel feet provide stability. Backing tray is galvanized in standard product, powder coating is optional. Comes in black, silver, white color options.

Color options:



Header / Topschild

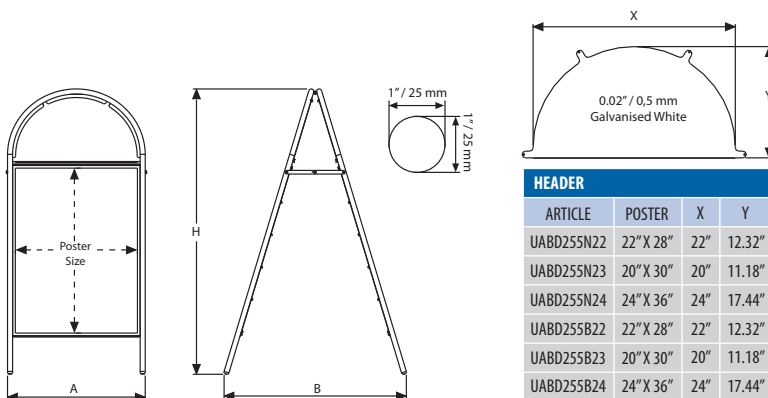

| HEADER | | ARTICLE | POSTER | X | Y |
|------------|-----------|---------|--------|---|---|
| UABD255N22 | 22" X 28" | 22" | 12.32" | | |
| UABD255N23 | 20" X 30" | 20" | 11.18" | | |
| UABD255N24 | 24" X 36" | 24" | 17.44" | | |
| UABD255B22 | 22" X 28" | 22" | 12.32" | | |
| UABD255B23 | 20" X 30" | 20" | 11.18" | | |
| UABD255B24 | 24" X 36" | 24" | 17.44" | | |

| MATERIAL : Iron A Board | | | | | WEIGHT | PACKING SIZE |
|-------------------------|-----------|--------|--------|--------|--------------|-------------------------|
| ARTICLE | POSTER | A | B | H | WITH PACKING | *W X H X D |
| UABD255N22 | 22" X 28" | 25.20" | 27.56" | 45.28" | 34.281 lbs | 26.38" X 51.97" X 2.95" |
| UABD255N23 | 20" X 30" | 23.15" | 33.46" | 48.03" | 33.730 lbs | 24.02" X 51.97" X 2.95" |
| UABD255N24 | 24" X 36" | 33.15" | 39.37" | 64.17" | 40.785 lbs | 31.89" X 70.87" X 2.95" |
| UABD255B22 | 22" X 28" | 25.20" | 27.56" | 45.28" | 34.281 lbs | 26.38" X 51.97" X 2.95" |
| UABD255B23 | 20" X 30" | 23.15" | 33.46" | 48.03" | 33.730 lbs | 24.02" X 51.97" X 2.95" |
| UABD255B24 | 24" X 36" | 33.15" | 39.37" | 64.17" | 40.785 lbs | 31.89" X 70.87" X 2.95" |



*W:Width H: Height D: Depth



Waterbase Pavement Signs



Stable, heavy and enduring pavement sign. Suitable to set aside in parking areas, play grounds, shop entrances and busy pavement roads; especially for windy areas. Standard in metallic RAL 9006 color. By opening the plastic stoppers, you can pour in either water or sand to make the stand heavier.

-  The product is packed unassembled. Each base is supplied with industrial salt to prevent freezing in winter conditions. Printing area has a +/- 0.06" tolerance in size.
-  No tool assembly.
-  Heavy base provides stability. Suitable for outdoor conditions. Stickers are not included in the original box.



Maximum water capacity is 152.163 ounces



Maximum water capacity is 169.070 ounces

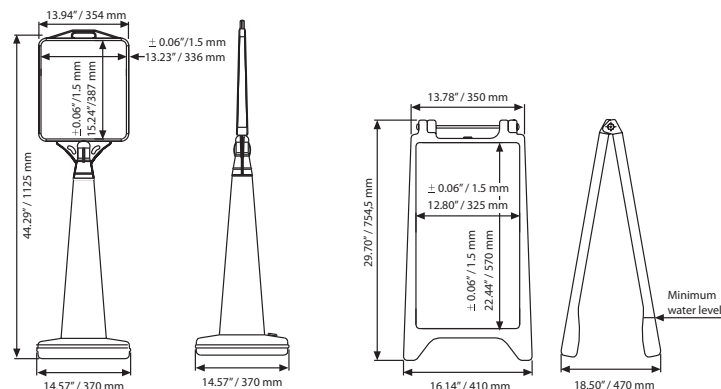

| MATERIAL : Polystyrene | | | WEIGHT | PACKING SIZE |
|------------------------|---------|-------------------|--------------|--------------------------|
| ARTICLE | MODEL | WEIGHT with water | WITH PACKING | *W X H X D |
| UWPS005000 | Pyramid | 12.125 lbs | 7.859lbs | 15.75" X 27.56" X 15.75" |
| UWPS001000 | A Board | 17.636 lbs | 7.848 lbs | 16.54" X 28.35" X 4.92" |

* W:Width H: Height D: Depth





PS Boards



See movie at our website www.mtdisplays.com.tr



Simple plastic pavement board for multiple purposes. PS Display is suitable for inkjet printing and adhesive folio. Easy to move and store. Suitable to write on with water base chalk pens.

-  Product is single packed.
-  No tool assembly.
-  Suitable for chalk pens. We sell pens individually in handy sets.



PS Chalk Board

PS Board

Carry PS Board

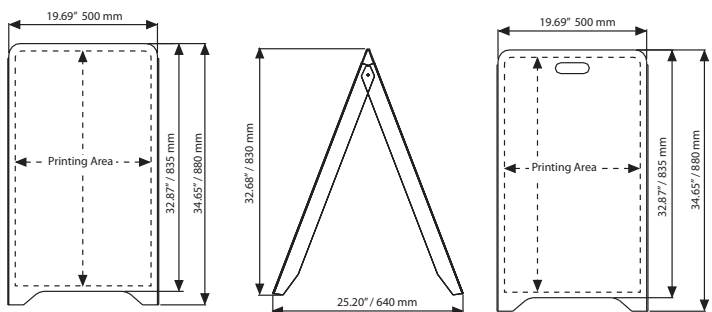

Chalkboard Marker
UYKLM1251 - Colour Marker
UYKLM1250 - White Marker

| MATERIAL : Polystrene | | | | WEIGHT | PACKING SIZE |
|-----------------------|-----------------|-----------------|----------------|--------------|-------------------------|
| ARTICLE | SIZE | PIRINTING AREA | MODEL | WITH PACKING | *W X H X D |
| UPYP000000 | 19.69" X 34.65" | 18.90" X 32.09" | PS Board | 9.479 lbs | 20.87" X 35.83" X 3.15" |
| UPYPE00000 | 19.69" X 34.65" | 18.90" X 32.09" | Carry PS Board | 9.479 lbs | 20.87" X 35.83" X 3.15" |
| UPYP001000 | 19.69" X 34.65" | 18.90" X 32.09" | PS Chalk Board | 9.479 lbs | 20.87" X 35.83" X 3.15" |

*W:Width H: Height D: Depth





Wood Displays

- Wooden Frames
- Wood Slide-in Frame
- Wood A Board Indoor
- Wood A Board Outdoor
- Timber Chalk Board
- Wood Chalk Floor Stand
- Wood Dry Erase Floor Stand
- Nature Line Writing Board
- Wall Mount Wooden Card Holder
- Wood Magazine Rack for Wall
- Free Standing Wood Magazine Rack
- Counter Wood Chalk Frame
- Desktop Easel
- Petite Desktop Easel
- Wooden Roll Stand
- Wood Folding Luggage Rack
- Foldable Wood Box



Chalkboard Markers are ideal for handwriting on boards.

They are waterproof and fade resistant outdoor. Yet remarkably their surfaces can be easily cleared of materials such as glass and plastics. This helps you to change your messages or prices. Our standard pen sets are defined next with the colors inside.



Easy to wipe off

Windows, board and all non-porous surfaces.



0.39" suitable for thick writing.

| BIG CHALKBOARD MARKER SET (5 Pcs) | | | | | |
|-----------------------------------|--------|--------|------|-------|--------|
| ARTICLE | COLOUR | | | | |
| UYAKLM1251 | Red | Yellow | Pink | Green | Orange |
| | | | | | |



0.39" suitable for thick writing.

| WHITE CHALKBOARD MARKER SET (3 Pcs) | |
|-------------------------------------|--------|
| ARTICLE | COLOUR |
| UYAKLM1250 | White |
| | |



Wooden Frames

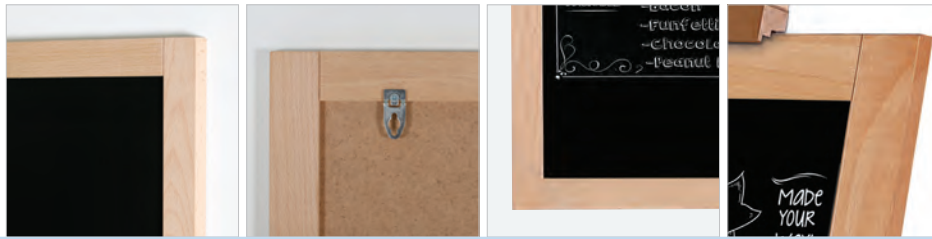

Suitable for the display of messages in restaurants, cafés, bars, malls, offices and education centers. The erasable surface enables you to erase your messages and transmit them to your audience while keeping them updated. You can use a chalkboard pen to write on the black surface. There are also special water-based and scent-free markers. We sell chalk pens individually 2 in convenient sets.

Each unit comes ready with mounting set, and easy to assemble instruction sheet.

Chalkboard pens are not included in the original pack, should be ordered separate. For spotless removing of chalk pens from surface, please use window & glass cleaner otherwise clean with damp cloth.

Easy to wipe off



← Beech wood

Easy Wood Frame



← Easel order separately.



Don't forget to order Chalkboard Marker
UYAKLM1251 - Colour Marker
UYAKLM1250 - White Marker

Easy Wood Frame

Frameless Wooden Frame

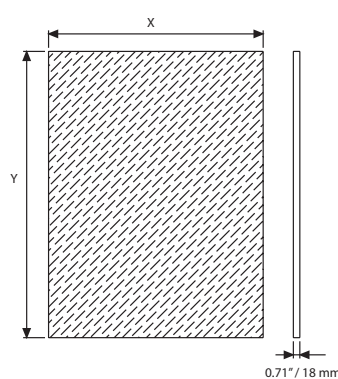
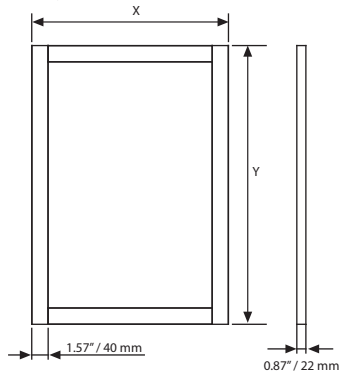

| EASY WOOD FRAME : Beech wood | | | WEIGHT | PACKING SIZE |
|------------------------------|-----------------|-----------------|--------------|-------------------------|
| ARTICLE | EXTERNAL (x-y) | SIZE | WITH PACKING | *W X H X D |
| UWSS010034 | 14.96" X 18.90" | 11.81" X 15.75" | 2,337 lbs | 15.75" X 20.08" X 0.94" |
| UWSS010046 | 18.90" X 26.77" | 15.75" X 23.62" | 3,638 lbs | 19.69" X 27.95" X 0.94" |
| UWSS010049 | 18.90" X 38.58" | 15.75" X 35.43" | 6,769 lbs | 19.69" X 39.76" X 0.94" |
| UWSS010068 | 26.77" X 34.65" | 23.62" X 31.50" | 7,497 lbs | 27.56" X 35.83" X 0.94" |
| UWSS010061 | 26.77" X 48.43" | 23.62" X 45.28" | 9,57 lbs | 27.56" X 51.57" X 0.94" |
| UWSS010081 | 34.65" X 50.39" | 31.50" X 47.24" | 11,135 lbs | 35.43" X 51.57" X 0.94" |

* W:Width H: Height D: Depth



Wood Slide-in Frame



Watch video at our website www.mtdisplays.com



Wood Podium is made of Beech plywood wood. It is a good lectern solution with 15 degrees viewing angle for ergonomic posture. It has an interior shelf for keeping notes and presentation materials organized. Poster clamp in front of the stand allows you to present your brand's logo for a professional fixture. Can be used at business conferences, universities, hotels, or even trade shows. To ensure sustainability of the quality, wood podium holders are lacquered finished.

Packed unassembled with an easy-to-understand instruction sheet & fixing elements.

With and without wheel options are available.

10 mm poster is placed within the clamping system. End caps help to slide the poster in and keeps.

1 pack. See info chart for pack sizes.

Assembly time approx 120 seconds.



Natural Wood



Hanger mounting for double sided use.



Landscape & portrait wall mounting

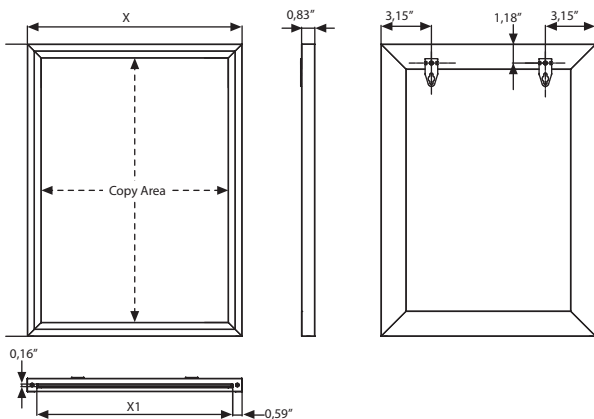

Don't forget to order
Chalkboard Marker
UYAKLM1251 - Colour Marker
UYAKLM1250 - White Marker

| MATERIAL : Beech wood | | | | | WEIGHT | PACKING SIZE |
|-----------------------|--------------|-----------------|------------|--------|--------------|-------------------------|
| DARK WOOD | NATURAL WOOD | EXTERNAL (x-y) | COPY AREA | X1 | WITH PACKING | *W X H X D |
| UWSFD00081 | UWSFN00081 | 10.24" X 12.76" | 8.5" X 11" | 9.06" | 1.279 lbs | 11.02" X 13.39" X 1.18" |
| UWSFD00017 | UWSFN00017 | 12.76" X 18.74" | 11" X 17" | 11.57" | 2.094 lbs | 13.39" X 19.69" X 1.18" |
| UWSFD00018 | UWSFN00018 | 19.76" X 25.75" | 18" X 24" | 18.58" | 3.638 lbs | 20.47" X 26.38" X 1.18" |
| UWSFD00022 | UWSFN00022 | 23.74" X 29.76" | 22" X 28" | 22.56" | 4.85 lbs | 24.41" X 30.31" X 1.18" |
| UWSFD00024 | UWSFN00024 | 25.75" X 37.76" | 24" X 36" | 24.57" | 6.393 lbs | 26.77" X 38.58" X 1.18" |



* W:Width H:Height D:Depth

Wood Chalk Floor Stand



Wood Chalk Floor Stand is made of beech wood. Lacquered finish is applied for long term use. It has a double sided dry-wipe chalk surface. Foldable support can be used on both sides. Chain provides stability. It is an excellent friendly way to advertise your business. Also, Wood Chalk Floor Stand offers perfect solution where announcements change frequently such as bars, restaurants, hotels and any more. 3 size options are available.

Der Wood Chalk Floor Stand ist aus Buchenholz gefertigt. Lackiertes Finish wird für den Langzeitgebrauch aufgetragen. Es hat eine doppelseitige, trocken abwischbare Kreideoberfläche. Faltbare Stütze beidseitig verwendbar. Kette sorgt für Stabilität. Es ist eine ausgezeichnete freundliche Art, für Ihr Unternehmen zu werben. Außerdem bietet der Wood Chalk Floor Stand die perfekte Lösung, wenn sich Ankündigungen häufig ändern, wie z. B. in Bars, Restaurants, Hotels und mehr. 3 Größenoptionen sind verfügbar.

Do not forget to order chalkboard marker. Vergessen Sie nicht, Tafelmarker zu bestellen.

Unassembled packaging. Unmontierte Verpackung.

Assembly in 10 seconds. Montage in 10 Sekunden.

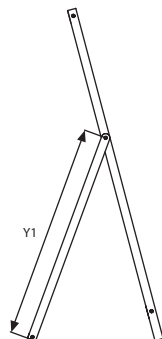
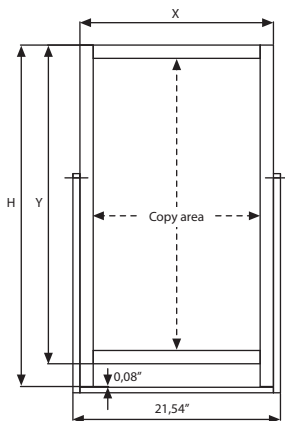
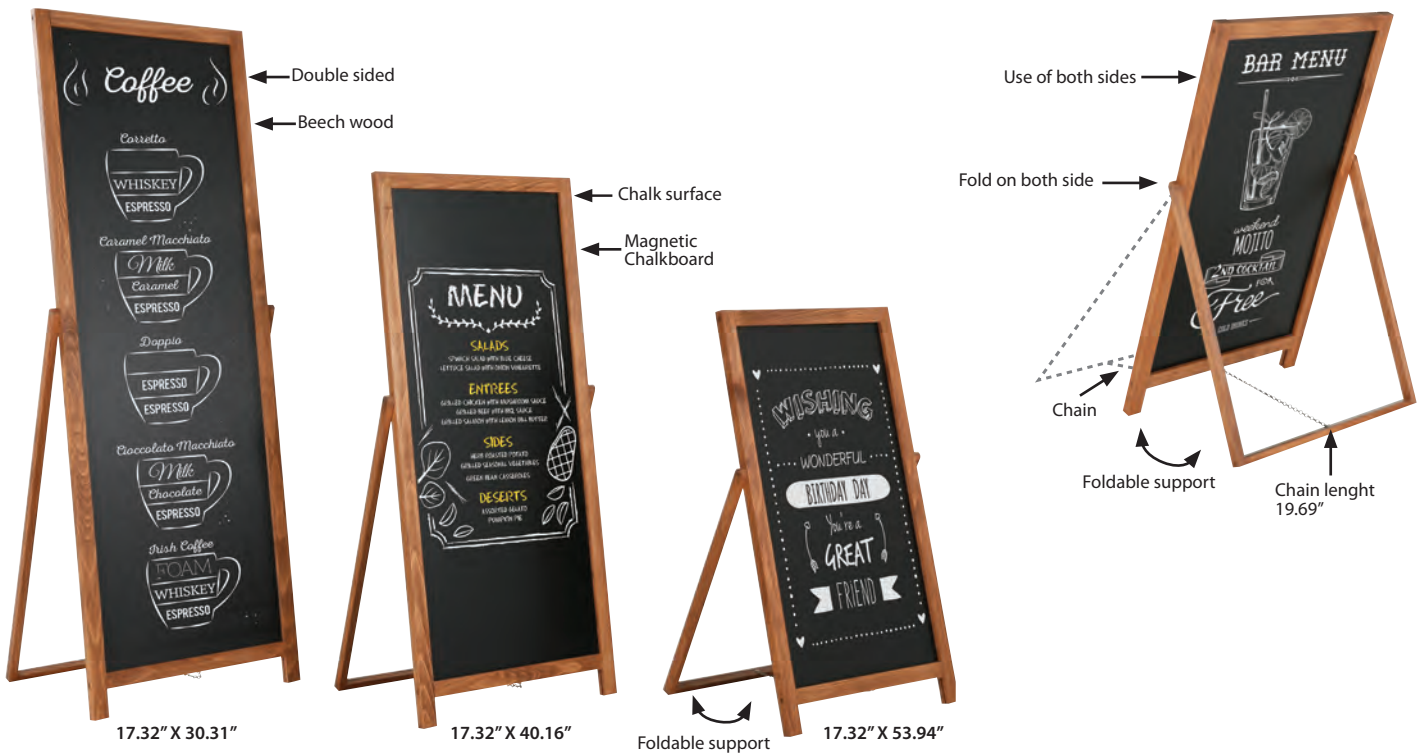

Don't forget to order Chalkboard Marker
UYAKLM1251 - Colour Marker
UYAKLM1250 - White Marker

| MATERIAL : Beech wood | | | | | WEIGHT | PACKING SIZE |
|-----------------------|-----------------|-----------------|--------|--------|-------------|-----------------------------------|
| ARTICLE | EXTERNAL (x-y) | COPY AREA | H | Y1 | DESCRIPTION | *W X H X D |
| UWCF50D010 | 20.08" X 33.07" | 17.32" X 30.31" | 35.43" | 22.30" | Dark Wood | 8,6 lbs 22.64" X 37.4" X 1.69 |
| UWCF50D020 | 20.08" X 42.91" | 17.32" X 40.16" | 45.28" | 27.62" | Dark Wood | 10,253 lbs 22.64" X 48.43" X 1.69 |
| UWCF50D030 | 20.08" X 44.88" | 17.32" X 53.94" | 59.06" | 34.11" | Dark Wood | 13,01 lbs 22.64" X 61.42" X 1.69 |



*W:Width H:Height D:Depth



Wood Dry Erase Floor Stand



Wood Dry Erase Floor Stand is made of fir wood. It has a double sided magnetic and dry-wipe chalkboard surface. It offers a perfect solution where announcements change frequently such as bars, restaurants, hotels and its wooden look creates a friendly atmosphere to your business advertisement. Foldable support can be used on both sides. Chain provides stability. 3 size options are available.

-  Do not forget to order chalkboard marker.
-  Unassembled packaging.
-  Assembly in 10 seconds.



17,32" X 30,31"

17,32" X 40,16"

17,32" X 53,94"

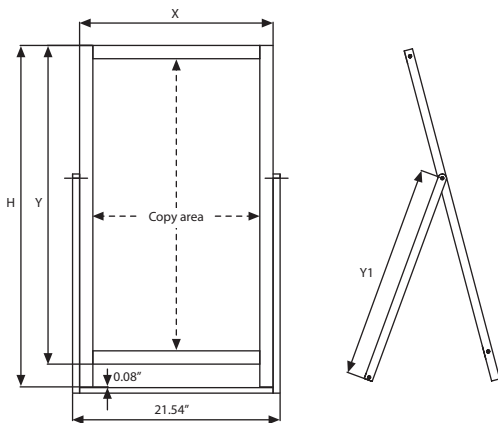

Don't forget to order Chalkboard Marker
UYAKLM1251 - Colour Marker
UYAKLM1250 - White Marker

| MATERIAL : Fir wood | | | | | | WEIGHT | PACKING SIZE |
|---------------------|-----------------|-----------------|--------|--------|-------------|--------------|-------------------------|
| ARTICLE | EXTERNAL (x-y) | COPY AREA | H | Y1 | DESCRIPTION | WITH PACKING | *W X H X D |
| UWDFS0D010 | 20.08" X 33.07" | 17.32" X 30.31" | 35.43" | 22.3" | Dark Wood | 8.6 lbs | 23.62" X 38.19" X 1.77" |
| UWDFS0D020 | 20.08" X 42.91" | 17.32" X 40.16" | 45.28" | 27.62" | Dark Wood | 10.253 lbs | 23.62" X 48.03" X 1.77" |
| UWDFS0D030 | 20.08" X 44.88" | 17.32" X 53.94" | 59.06" | 34.11" | Dark Wood | 13.01 lbs | 23.62" X 61.81" X 1.77" |

*W:Width H: Height D: Depth



Nature Line Writing Board

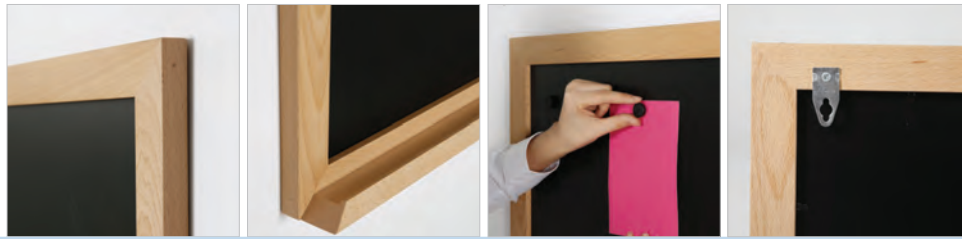

Suitable for the display of messages in restaurants, cafés, bars, malls, offices and education centers. The erasable surface enables you to erase your messages and transmit them to your audience while keeping them updated. You can use a chalkboard pen to write on the black surface. There are also special water-based and scent-free markers. We sell chalk pens individually 2 in convenient sets.

 Each unit comes ready with mounting set, and easy to assemble instruction sheet.

 Chalkboard pens are not included in the original pack, should be ordered separate. For spotless removing of chalk pens from surface, please use window & glass cleaner otherwise clean with damp cloth.

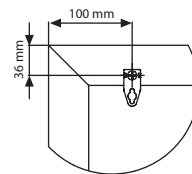
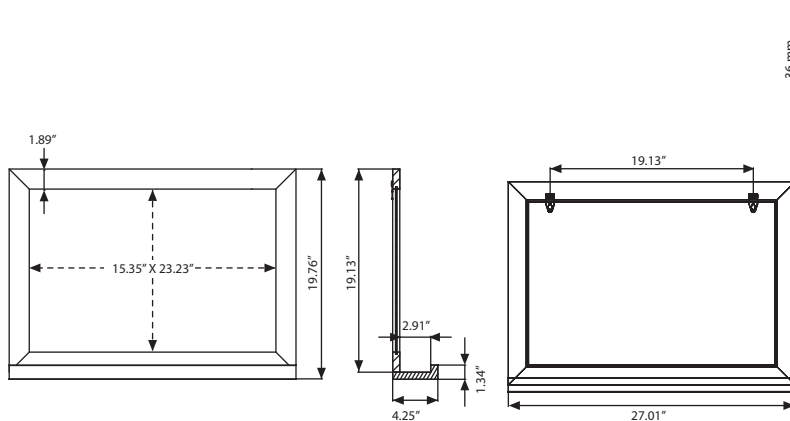
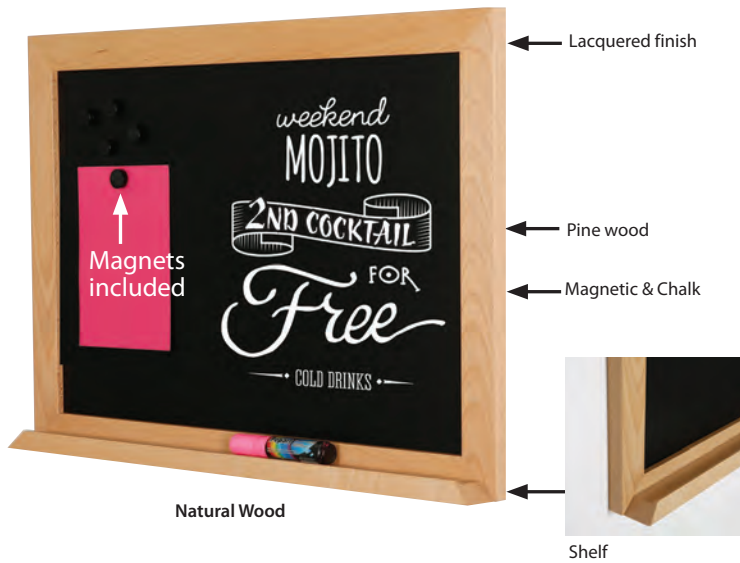

4 magnetic buttons included in the box



Don't forget to order Chalkboard Marker
UYAKLM1251 - Colour Marker
UYAKLM1250 - White Marker

| MATERIAL : Pine Wood | | | WEIGHT | PACKING SIZE |
|----------------------|-----------------|---------------------------------|--------------|-------------------------|
| ARTICLE | PANEL SIZE | DESCRIPTION | WITH PACKING | *W X H X D |
| UWNLWONOF2 | 15.75" X 23.62" | Natural Wood - Black Chalkboard | 5.027 lbs | 22.44" X 28.74" X 1.77" |
| UWNLWODOF2 | 15.75" X 23.62" | Dark Wood - Black Chalkboard | 5.027 lbs | 22.44" X 28.74" X 1.77" |



*W:Width H: Height D: Depth

Wood A Board Outdoor



It is made of solid wood. Aluminum composite backing provides availability for open air usage for Outdoor A Board.

The erasable surface enables for erasing the messages and transmit them to your audience while keeping as updated easily. Chalkboard pen can be used for black surfaces to display the messages. Also water-based and scent free markers are proper for writing on it. Suitable for outdoor places such as restaurants, cafes, bars, malls, offices and education centers.

Each unit comes ready to use without any tool for assembly.

Chalkboard pen should be ordered separately. Henge and chain is different on 18.11"x26.77" than other sizes which aims to increase performance of small size.

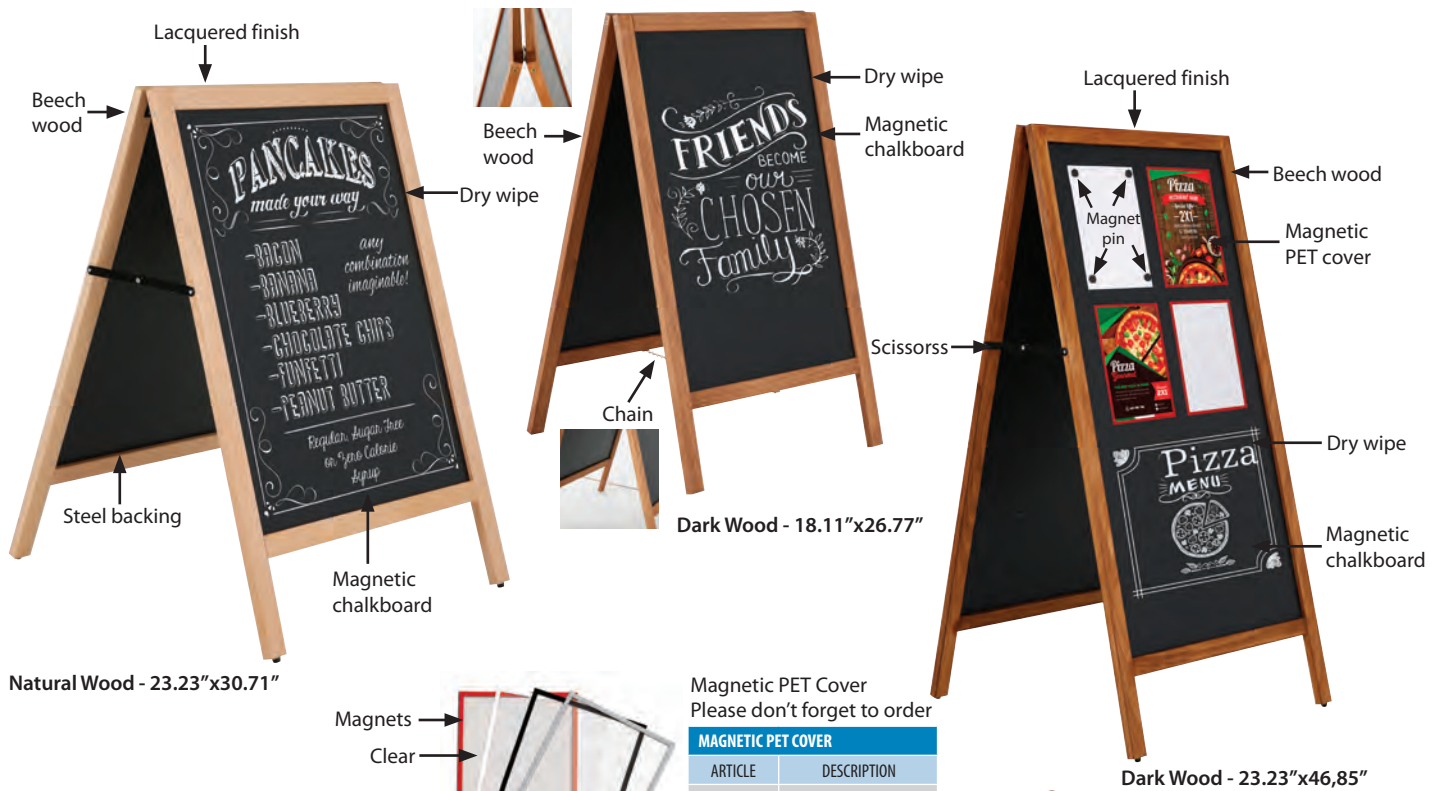

Natural Wood - 23.23"x30.71"

Dark Wood - 18.11"x26.77"

Dark Wood - 23.23"x46.85"

Magnetic PET Cover
Please don't forget to order

| MAGNETIC PET COVER | |
|--------------------|---------------------------|
| ARTICLE | DESCRIPTION |
| UPCMOR00A4 | Magnetic 8.5" X 11" Red |
| UPCMOB00A4 | Magnetic 8.5" X 11" Black |
| UPCMOW00A4 | Magnetic 8.5" X 11" White |
| UPCMOG00A4 | Magnetic 8.5" X 11" Gray |



Don't forget to order
Chalkboard Marker
UYAKLM1251 - Colour Marker
UYAKLM1250 - White Marker

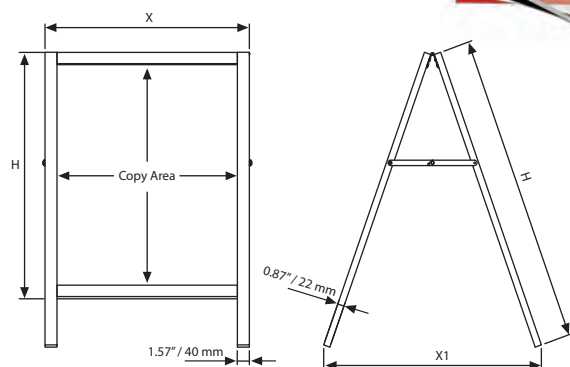

| MATERIAL : Beech wood | | | | | | WEIGHT | PACKING SIZE |
|-----------------------|-----------------|-----------------|--------------|--------|--------|--------------|-------------------------|
| ARTICLE | EXTERNAL (x-y) | SIZE | DESCRIPTION | H | X1 | WITH PACKING | *W X H X D |
| UWOD004668 | 21.26" X 29.92" | 18.11" X 26.77" | Natural Wood | 37.40" | 20.08" | 17.196 lbs | 22.05" X 37.40" X 2.36" |
| UWOD004668 | 21.26" X 29.92" | 18.11" X 26.77" | Dark Wood | 37.40" | 20.08" | 17.196 lbs | 22.05" X 37.40" X 2.36" |
| UWOD006078 | 26.38" X 33.86" | 23.23" X 30.71" | Natural Wood | 41.34" | 22.05" | 18.673 lbs | 28.15" X 41.34" X 2.17" |
| UWOD006078 | 26.38" X 33.86" | 23.23" X 30.71" | Dark Wood | 41.34" | 22.05" | 18.673 lbs | 28.15" X 41.34" X 2.17" |
| UWOD006012 | 26.38" X 50" | 23.23" X 46.85" | Natural Wood | 57.09" | 29.53" | 33.422 lbs | 28.15" X 58.66" X 2.36" |
| UWOD006012 | 26.38" X 50" | 23.23" X 46.85" | Dark Wood | 57.09" | 29.53" | 33.422 lbs | 28.15" X 58.66" X 2.36" |

*W:Width H: Height D: Depth



Wood A Board Indoor



It is made of solid wood. MDF backing provides availability for closed area usage for Indoor A Board. The erasable surface enables for erasing the messages and transmit them to your audience while keeping as updated. Chalkboard pen can be used for black surfaces to display the messages. Also water-based and scent free markers are proper for writing on it. Suitable for indoor places such as restaurants, cafes, bars, malls, offices and education centers.

- Each unit comes ready to use without any tool for assembly
- Chalkboard pen should be ordered separately.

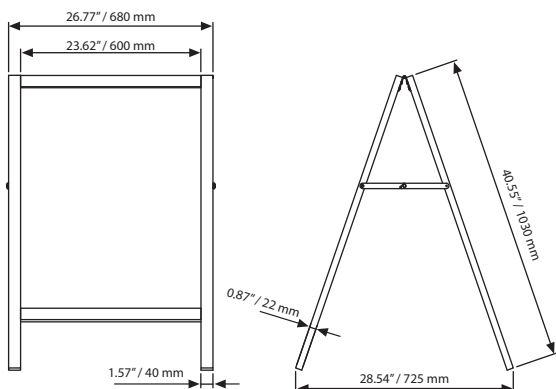

Don't forget to order
Chalkboard Marker
UYAKLM1251 - Colour Marker
UYAKLM1250 - White Marker

| MATERIAL : Beech wood | | WEIGHT | PACKING SIZE |
|-----------------------|-----------------|--------------|-------------------------|
| ARTICLE | SIZE | WITH PACKING | *W X H X D |
| UWID006078 | 23.62" X 30.71" | 16.865 lbs | 28.15" X 41.34" X 2.17" |

*W:Width H:Height D:Depth



Timber Chalk Board



Timber Chalk Board is made of solid Beech wood. Slide in panels are galvanised steel sheets which ensures for outdoor use as heavy and rust-free. The erasable surface enables for erasing the messages and transmit them to your audience while keeping as updated easily. Slide in panels are double sided to make sure timely use of A Frame. So two different messages of advertisement can be stored on the panels. Chalk or chalkboard water-based pen can be used for black surfaces to display the messages. Suitable for outdoor places such as restaurants, cafes, bars, malls, offices and many more.



Each unit comes ready to use



Chalkboard pen and magnetic covers should be ordered separately.



Natural Wood



Dark Wood

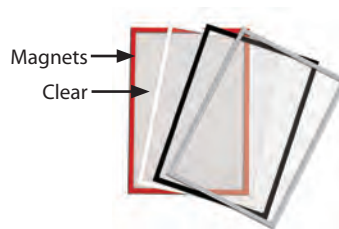
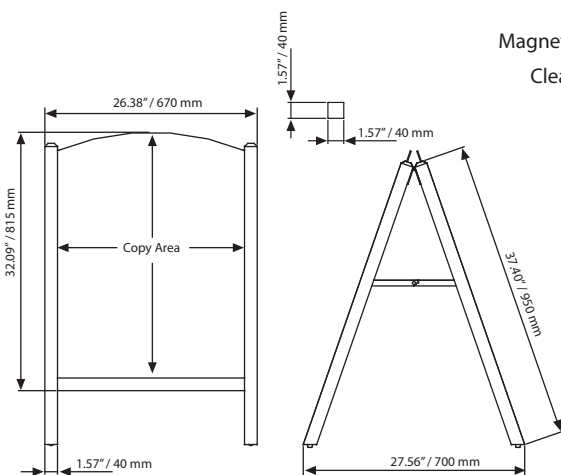

Magnetic PET Cover
Please don't forget to order

| MAGNETIC PET COVER | |
|--------------------|---------------------------|
| ARTICLE | DESCRIPTION |
| UPCMOR00A4 | Magnetic 8.5" X 11" Red |
| UPCMOB00A4 | Magnetic 8.5" X 11" Black |
| UPCMOW00A4 | Magnetic 8.5" X 11" White |
| UPCMOG00A4 | Magnetic 8.5" X 11" Gray |



Don't forget to order
Chalkboard Marker
UYAKLM1251 - Colour Marker
UYAKLM1250 - White Marker

| MATERIAL : Beech wood | | | | WEIGHT | PACKING SIZE |
|-----------------------|-----------------|-----------------|----------------------|--------------|-------------------------|
| ARTICLE | SIZE | COPY | DESCRIPTION | WITH PACKING | *W X H X D |
| UWTC006078 | 26.77" X 30.71" | 23.23" X 30.51" | Natural Wood-Outdoor | 30.467 lbs | 27.17" X 40.55" X 4.33" |
| UWTC006078 | 26.77" X 30.71" | 23.23" X 30.51" | Dark Wood-Outdoor | 30.467 lbs | 27.17" X 40.55" X 4.33" |
| UWTC016078 | 26.77" X 30.71" | 23.23" X 30.51" | Natural Wood-Indoor | 23.545 lbs | 27.17" X 40.55" X 4.33" |
| UWTC016078 | 26.77" X 30.71" | 23.23" X 30.51" | Dark Wood-Indoor | 23.545 lbs | 27.17" X 40.55" X 4.33" |



*W:Width H:Height D:Depth



Wall Mount Wooden Card Holder



See movie at our website www.mtdisplays.com.tr



Wall Mount Wooden Card Holder is designed to store and information packages in one convenient location. It is constructed of lacquered finished beech wood. Clear Acrylic pockets provide a full view of flyers or brochures stored in. The pockets are tiered one on top of each other. It provides you gain a wider area in offices, banks, schools, hospitals, hotels and more.

-  Each unit comes ready to use without any tool for assembly.
-  Complete with wall hangers.
-  Assembly time approx 30 seconds.

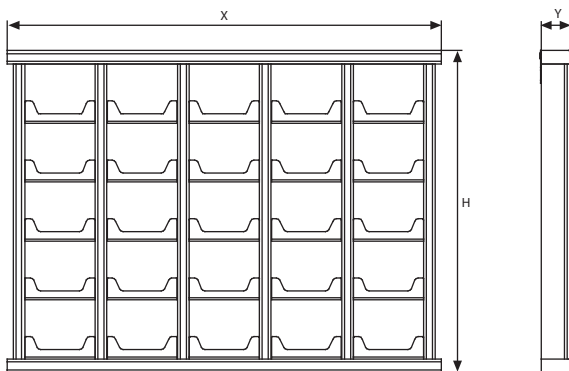
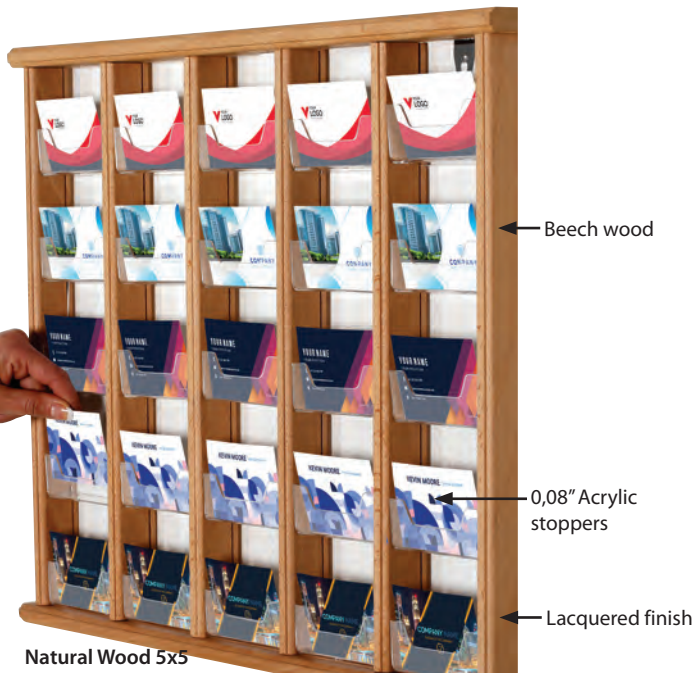

| MATERIAL : Beech wood | | | | | | WEIGHT | PACKING SIZE |
|-----------------------|----------|--------------|--------|-------|--------|--------------|-------------------------|
| ARTICLE | CAPACITY | DESCRIPTION | X | Y | H | WITH PACKING | *W X H X D |
| UWCHWN0035 | 3 X 5 | Natural Wood | 14.57" | 1.57" | 17.32" | 4.409 lbs | 15.75" X 18.50" X 2.36" |
| UWCHWN0055 | 5 X 5 | Natural Wood | 23.23" | 1.57" | 17.32" | 6.393 lbs | 18.11" X 24.02" X 2.36" |
| UWCHWD0035 | 3 X 5 | Dark Wood | 14.57" | 1.57" | 17.32" | 4.409 lbs | 15.75" X 18.50" X 2.36" |
| UWCHWD0055 | 5 X 5 | Dark Wood | 23.23" | 1.57" | 17.32" | 6.393 lbs | 18.11" X 24.02" X 2.36" |

*W:Width H: Height D: Depth





Desktop Easel



Desktop Easel is made of beech wood. Lacquered finish is applied for long term use. Chalkboard is included. It is suitable for desktop usage. Its modern and traditional combination wooden look creates a friendly atmosphere to your business, menu or announcements. It has a dry-wipe chalkboard surface that is easy to change notes. Natural rope provides stability. Its foldable flat design is space saving.

 Chalkboard is included. Do not forget to chalkboard marker.

Unassembled packaging.

  Assembly in 10 seconds.

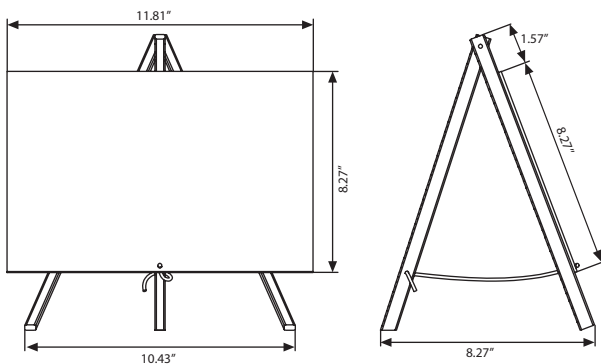

Don't forget to order
Chalkboard Marker
UYAKLM1251 - Colour Marker
UYAKLM1250 - White Marker

| MATERIAL : Beech wood | | | WEIGHT | PACKING SIZE |
|-----------------------|-------------------------------|------------------------------|--------------|-------------------------|
| ARTICLE | SIZE | DESCRIPTION | WITH PACKING | *W X H X D |
| UWDECD00A4 | 8.5" X 11" - 215,9 X 279,4 mm | Dark Wood - Black Chalkboard | 1,544 lbs | 12.99" X 14.57" X 0.87" |

*W:Width H: Height D: Depth





Petite Desktop Easel



Petite Desktop Easel is made of beech wood. Lacquered finish is applied for long term use. Its modern and traditional combination wooden look creates a friendly atmosphere to your business, menu or announcements. Adjustable back support helps to achieve perfect placement. Its foldable flat design is space saving. Optional chalk panel max. size is 8.5" x 11".

 Do not forget to chalk panel and chalkboard marker.

 Optional chalk panel max. size is 8.5"x11".

 Assembly in 10 seconds.

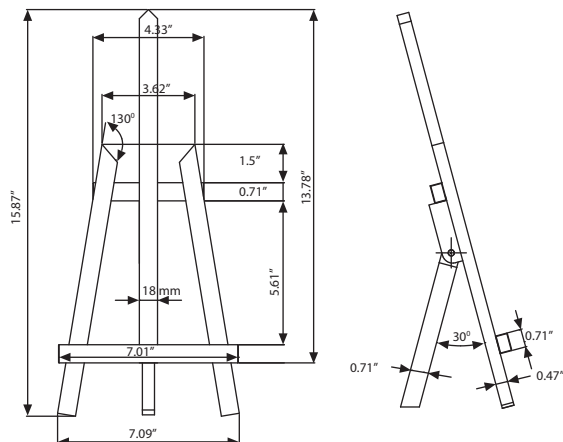

Don't forget to order
Chalkboard Marker
UYAKLM1251 - Colour Marker
UYAKLM1250 - White Marker

| MATERIAL : Beech wood | | | WEIGHT | PACKING SIZE |
|-----------------------|--------------|---------------------------------|--------------|-------------------|
| ARTICLE | SIZE (x-y) | DESCRIPTION | WITH PACKING | *W X H X D |
| UWDEPN0010 | 410 X 180 mm | Natural Wood - Black Chalkboard | 0,310 kg | 210 X 430 X 55 mm |

*W:Width H: Height D: Depth



Counter Wood Chalk Frame



Counter Wood Chalk Frame is made of beech wood. Lacquered finish is applied for long term use. Foldable support provides stability. It is suitable for desktop usage and 3 size options are available. Its wooden look creates a friendly atmosphere to your business, menu or announcements. It has a dry-wipe chalkboard surface that easy to change notes. Chalkboard marker is optional.



Do not forget to chalkboard marker.

Unassembled packaging.



Assembly in 10 seconds.

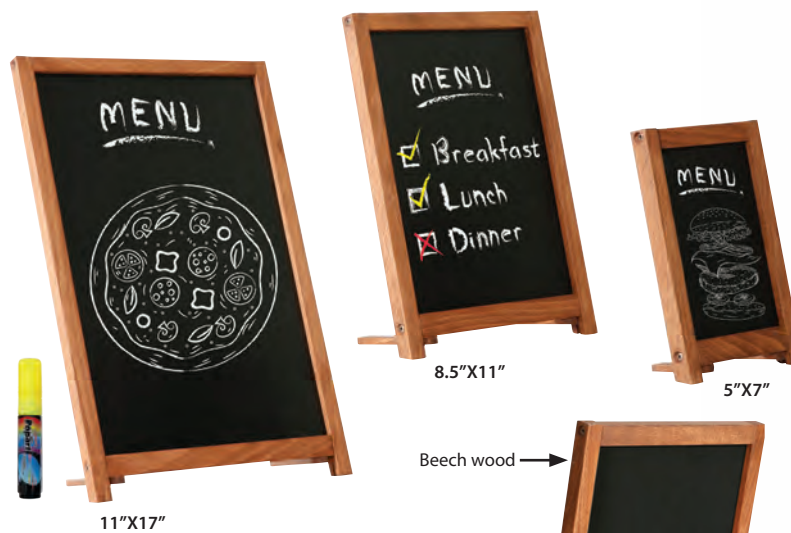

Beech wood

Black chalkboard

Lacquered finish

Foldable support

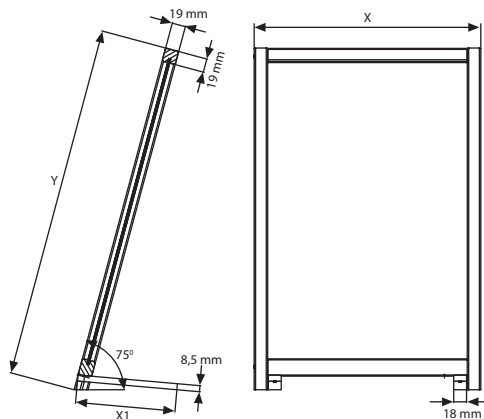

Don't forget to order
Chalkboard Marker
UYAKLM1251 - Colour Marker
UYAKLM1250 - White Marker

| MATERIAL : Beech wood | | | | | WEIGHT | PACKING SIZE |
|-----------------------|----------------|-------------------------------|--------|------------------------------|--------------|-------------------|
| ARTICLE | EXTERNAL (x-y) | SIZE | X1 | DESCRIPTION | WITH PACKING | *W X H X D |
| UWCFD00057 | 165 X 235 mm | 5" X 7" - 127 X 177,8 mm | 60 mm | Dark Wood - Black Chalkboard | 0,350 kg | 190 X 260 X 30 mm |
| UWCFD00081 | 254 X 341 mm | 8.5" X 11" - 215,9 X 279,4 mm | 100 mm | Dark Wood - Black Chalkboard | 0,600 kg | 280 X 360 X 30 mm |
| UWCFD00017 | 318 X 496,5 mm | 11" X 17" - 279,4 X 431,8 mm | 140 mm | Dark Wood - Black Chalkboard | 0,950 kg | 340 X 510 X 30 mm |



*W:Width H:Height D:Depth



Wooden Roll Stand



Wooden Roll Stand is made of plywood. Lacquered finish is applied for long term use. It has 9 rolls capacity. It has 4 wheels that 2 of them are caster wheels. Equipped with handle for easy carriage.

-  Has 9 rolls capacity.
-  Unassembled packaging.
-  Assembly in 10 seconds.

4 wheels, 2 with casters

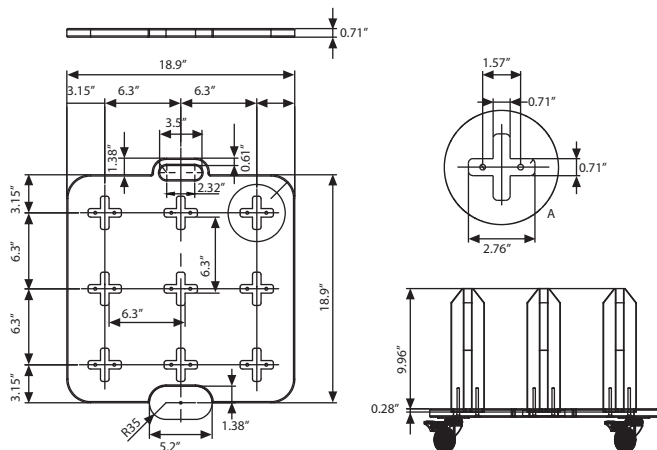
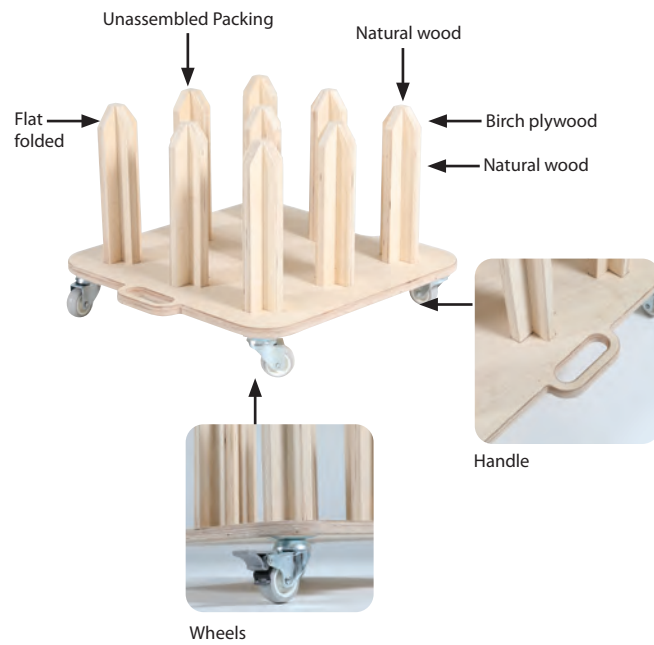

| MATERIAL : Birch wood | | | WEIGHT | PACKING SIZE |
|-----------------------|---------------|--------------|--------------|-------------------------|
| ARTICLE | SIZE | DESCRIPTION | WITH PACKING | *W X H X D |
| UWRSON0000 | 18.9" X 18.9" | Natural Wood | 19,404 lbs | 19.69" X 21.26" X 3.94" |

*W:Width H:Height D:Depth







Wood Folding Luggage Rack



Watch video at our website www.mtdisplays.com



Wood Folding Luggage Rack is made of beech wood. Lacquered finish is applied for long term use. It is equipped with woven strips. Its shelf has 198,45 lbs carriage capacity. It has with or without shelf options. Foldable flat design is space saving.

-  With or without shelf options.
-  Shelf has 198,45 lbs carriage capacity.
-  Assembly in 10 seconds.
-  1 box.

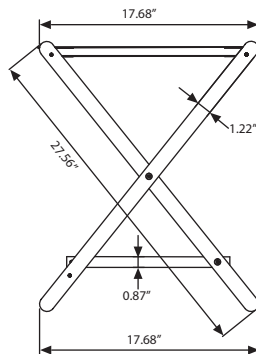
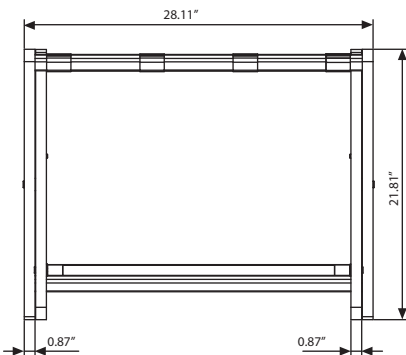
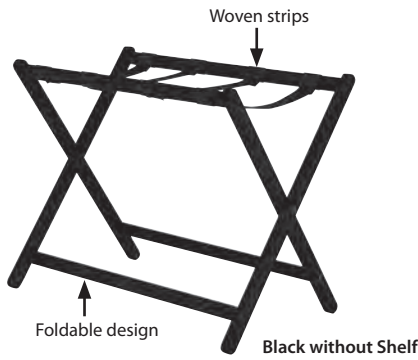
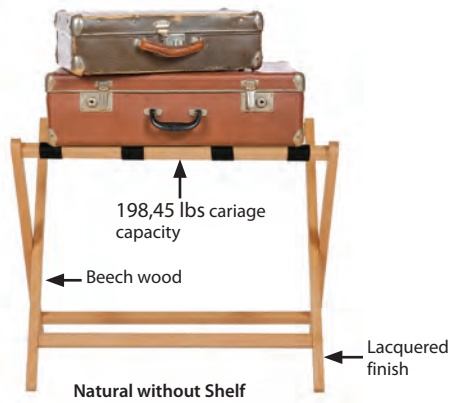

| MATERIAL : Beech wood | | | WEIGHT | PACKING SIZE |
|-----------------------|------------|--------------|--------------|-------------------------|
| WITHOUT SHELF | WITH SHELF | DESCRIPTION | WITH PACKING | *W X H X D |
| UWFLR1N000 | UWFLR2N000 | Natural Wood | 8,6 lbs | 28.74" X 29.13" X 3.15" |
| UWFLR1D000 | UWFLR2D000 | Dark Wood | 8,6 lbs | 28.74" X 29.13" X 3.15" |
| UWFLR1B000 | UWFLR2B000 | Black | 8,6 lbs | 28.74" X 29.13" X 3.15" |

* W:Width H: Height D: Depth







Wood Magazine Rack for Wall



See movie at our website www.mtdisplays.com.tr



Wood Magazine Rack for Wall is designed to store and organize magazines, catalogs, flyers and information packages in one convenient location. It is one of the best and space saving organizers for busy areas. Back and sides are constructed of lacquered finished beech wood. Clear PET G pockets provide a full view of flyers or brochures stored in. The pockets are tiered one on top of each other. It provides you gain a wider area in travel agents, offices, banks, schools, hospitals, hotels and more. Mountseasily on the wall.

-  Product is packed assembled.
-  Complete with wall hangers.
-  No tool assembly & ready to use.
-  Assembly time approx 80 seconds.

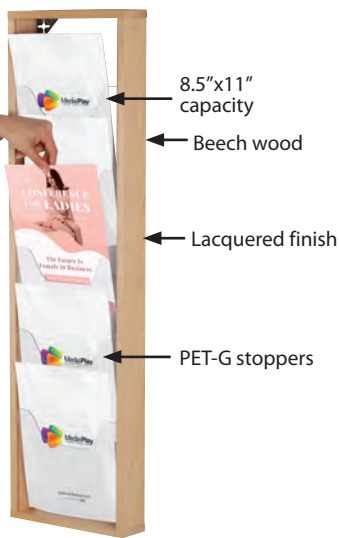

Natural Wood 1x5 (8.5"x11")



Dark Wood 2x5 (8.5"x11")



Natural Wood 3x5 (8.5"x11")



Dark Wood 4x5 (8.5"x11")

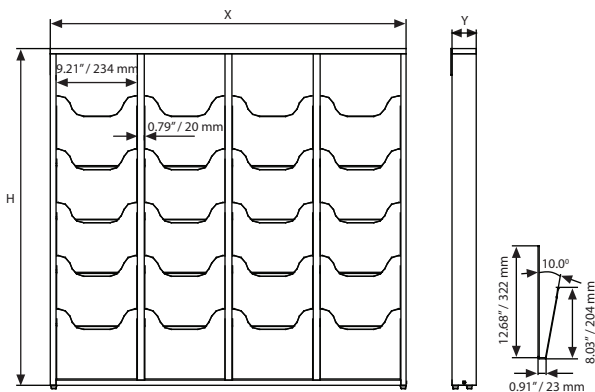

| MATERIAL : Beech wood | | | | | | | | WEIGHT | PACKING SIZE |
|-----------------------|-----------------|------------------|--------------|--------|-------|--------|--------------|-------------------------|--------------|
| ARTICLE | POSTER SIZE | CAPACITY | DESCRIPTION | X | Y | H | WITH PACKING | *W X H X D | |
| UWMRWN15A4 | 5 X (8.5"X11") | 1 X 5 (8.5"X11") | Natural Wood | 10.43" | 2.95" | 38.03" | 8.377 lbs | 11.42" X 41.34" X 3.54" | |
| UWMRWN25A4 | 10 X (8.5"X11") | 2 X 5 (8.5"X11") | Natural Wood | 20.47" | 2.95" | 38.03" | 14.330 lbs | 21.26" X 41.34" X 3.54" | |
| UWMRWN35A4 | 15 X (8.5"X11") | 3 X 5 (8.5"X11") | Natural Wood | 30.51" | 2.95" | 38.03" | 22.928 lbs | 31.50" X 41.34" X 3.54" | |
| UWMRWN45A4 | 20 X (8.5"X11") | 4 X 5 (8.5"X11") | Natural Wood | 40.16" | 2.95" | 38.03" | 26.455 lbs | 41.54" X 41.34" X 3.54" | |
| UWMRD15A4 | 5 X (8.5"X11") | 1 X 5 (8.5"X11") | Dark Wood | 10.43" | 2.95" | 38.03" | 8.377 lbs | 11.42" X 41.34" X 3.54" | |
| UWMRD25A4 | 10 X (8.5"X11") | 2 X 5 (8.5"X11") | Dark Wood | 20.47" | 2.95" | 38.03" | 14.330 lbs | 21.26" X 41.34" X 3.54" | |
| UWMRD35A4 | 15 X (8.5"X11") | 3 X 5 (8.5"X11") | Dark Wood | 30.51" | 2.95" | 38.03" | 22.928 lbs | 31.50" X 41.34" X 3.54" | |
| UWMRD45A4 | 20 X (8.5"X11") | 4 X 5 (8.5"X11") | Dark Wood | 40.16" | 2.95" | 38.03" | 26.455 lbs | 41.54" X 41.34" X 3.54" | |

*W:Width H: Height D: Depth



Free Standing Wood Magazine Rack



See movie at our website www.mtdisplays.com.tr



Free Standing Wood Magazine Rack is designed to store and organize magazines, catalogs, flyers and information packages in one convenient location. Back and sides are constructed of lacquered finished beech wood. Clear PET G pockets provide a full view of flyers or brochures stored in. The pockets are tiered one on top of each other. It provides you gain a wider area in offices, banks, schools, hospitals, hotels and more.



Product is packed unassembled with an easy to understand instruction for assembly.



Complete with fixing components.



Easy to assemble.



Assembly time approx 30 seconds.



Natural Wood 1x5 (8.5"x11")

Dark Wood 2x5 (8.5"x11")

Natural Wood 3x5 (8.5"x11")

Dark Wood 4x5 (8.5"x11")

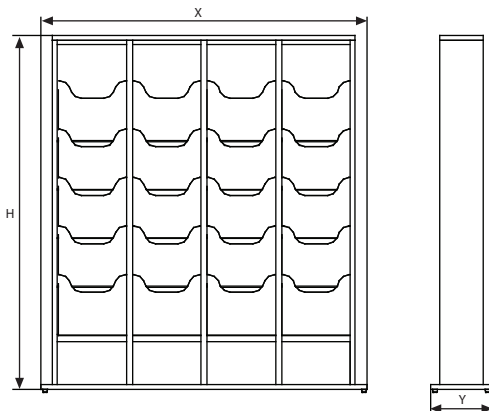

| MATERIAL : Beech wood | | | | | | | WEIGHT | PACKING SIZE |
|-----------------------|-----------------|------------------|--------------|--------|-------|--------|--------------|-----------------------|
| ARTICLE | POSTER SIZE | CAPACITY | DESCRIPTION | X | Y | H | WITH PACKING | *W X H X D |
| UWMRFN15A4 | 10 X (8.5"X11") | 1 X 5 (8.5"X11") | Natural Wood | 13.58" | 8.07" | 46.26" | 22.487 lbs | 11.42"X 46.85"X 7.68" |
| UWMRFN25A4 | 20 X (8.5"X11") | 2 X 5 (8.5"X11") | Natural Wood | 23.62" | 8.07" | 46.26" | 37.147 lbs | 21.65"X 46.85"X 7.68" |
| UWMRFN35A4 | 30 X (8.5"X11") | 3 X 5 (8.5"X11") | Natural Wood | 33.27" | 8.07" | 46.26" | 53.903 lbs | 31.50"X 46.85"X 7.68" |
| UWMRFN45A4 | 40 X (8.5"X11") | 4 X 5 (8.5"X11") | Natural Wood | 42.91" | 8.07" | 46.26" | 69.335 lbs | 41.54"X 46.85"X 7.68" |
| UWMRFD15A4 | 10 X (8.5"X11") | 1 X 5 (8.5"X11") | Dark Wood | 13.58" | 8.07" | 46.26" | 22.487 lbs | 11.42"X 46.85"X 7.68" |
| UWMRFD25A4 | 20 X (8.5"X11") | 2 X 5 (8.5"X11") | Dark Wood | 23.62" | 8.07" | 46.26" | 37.147 lbs | 21.65"X 46.85"X 7.68" |
| UWMRFD35A4 | 30 X (8.5"X11") | 3 X 5 (8.5"X11") | Dark Wood | 33.27" | 8.07" | 46.26" | 53.903 lbs | 31.50"X 46.85"X 7.68" |
| UWMRFD45A4 | 40 X (8.5"X11") | 4 X 5 (8.5"X11") | Dark Wood | 42.91" | 8.07" | 46.26" | 69.335 lbs | 41.54"X 46.85"X 7.68" |

*W:Width H:Height D:Depth



Wood Podium



See movie at our website www.mtdisplays.com.tr



Wood Podium is made of Beech plywood wood. It is a good lectern solution with 15 degrees viewing angle for ergonomic posture. It has an interior shelf for keeping notes and presentation materials organized. Poster clamp in front of the stand allows you to present your brand's logo for a professional fixture. Can be used at business conferences, universities, hotels, or even trade shows. To ensure sustainability of the quality, wood podium holders are lacquered finished.

- Packed unassembled with an easy-to-understand instruction sheet & fixing elements.
- With and without wheel options are available.
- 10 mm poster is placed within the clamping system. End caps help to slide the poster in and keeps.
- 1 pack. See info chart for pack sizes.
- Assembly time approx 120 seconds.



Black without wheels

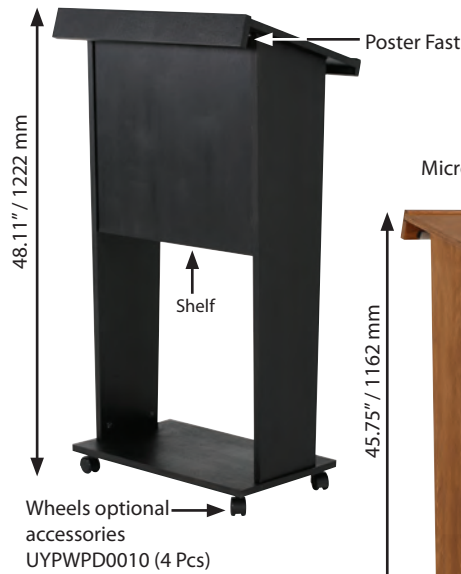

Black with wheels



Dark Wood without wheels



Dark Wood with wheels

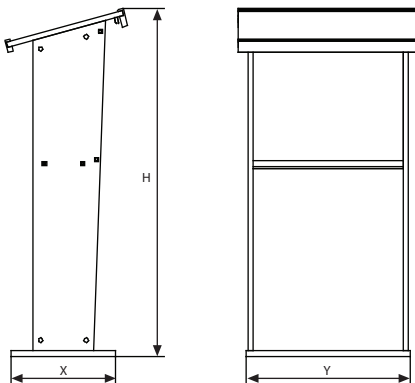

| MATERIAL : Beech plywood | | | | | WEIGHT | PACKING SIZE |
|--------------------------|-------------|--------|--------|--------|--------------|-------------------------|
| ARTICLE | DESCRIPTION | X | Y | H | WITH PACKING | *W X H X D |
| UWPDD00000 | Dark Wood | 13.78" | 21.65" | 45.75" | 41.887 lbs | 20.08" X 44.88" X 3.74" |
| UWPDB00000 | Black | 13.78" | 21.65" | 45.75" | 41.887 lbs | 20.08" X 44.88" X 3.74" |

*W:Width H: Height D: Depth



Foldable Wood Box





new



See movie at our website www.mtdisplays.com.tr



Foldable Wood Box is made of solid pine wood. Suitable for use in restaurants, cafés and various retail stores for decorative purpose or separate different areas. Can be used for store items like plants, pottery, or other decorative items. Rustic look makes these wood boxes both practical and decorative. 2 rope handles on each side help to hold the box.

-  Packed unassembled with an easy-to-understand instruction sheet & fixing elements.
-  No tool assembly.
-  Once mounted, can't be dismantled.
-  1 pack. See info chart for pack sizes.
-  Assembly time approx 20 seconds.



Pine wood →

↑ Lacquered finish



Flat pack

| MATERIAL : Pine wood | | | WEIGHT | PACKING SIZE |
|----------------------|------------|-------------|--------------|-------------------------|
| ARTICLE | SIZE | DESCRIPTION | WITH PACKING | *W X H X D |
| UWFBM01116 | 11"X16"X6" | Dark Wood | 6,064 lbs | 13.39" X 17.72" X 2.56" |
| UWFBM01420 | 14"X20"X8" | Dark Wood | 8,82 lbs | 16.93" X 21.65" X 2.56" |
| UWFBM01432 | 14"X32"X8" | Dark Wood | 11,576 lbs | 16.93" X 33.46" X 2.56" |
| UWFBM01445 | 14"X45"X8" | Dark Wood | 19,845 lbs | 16.93" X 46.85" X 2.56" |
| UWFBM02050 | 20"X50"X8" | Dark Wood | 22,05 lbs | 23.23" X 51.57" X 2.48" |

*W:Width H: Height D: Depth





Stanchions

- Q Belt
- Q Belt for Wall
- Retractable Stanchion Crowd Control Posts
- Crowd Control Stanchion Poles & Ropes
- Q Rope
- Street Barrier



Q Belt



See movie at our website www.mtdisplays.com.tr



Retractable crowd control system, Q Belt, is ready to use in place which offers a choice of post finishes combined with a selection of belt colours. It is suitable to be used wherever people come together. Such as airports, cinema halls, hotels, museums etc. 4 way pole provides the flexibility to create the optimum pedestrian flow. Retractable tape is controlled with tension to keep the tape straight when the tape is moved or pulled out. Q Belt is constructed from sturdy, durable steel. It features with rubberized and heavy weight base.

114.17 tape (+/- 1.97") is available in 3 colour: Black, Red and Blue.

Post and base is available in Silver, Chrome and Black.

Tape is suitable for branding in printing size of max 1.57"x106.30". Belt length may change between 82.68"-114.17" depending on belt color and double side printing option and print design.

2 packs. See info chart for pack sizes.

Choice of 3 Belt colours:

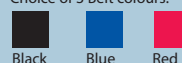

Accessories available!

Available only 8.5"x11" Landscape & Portrait

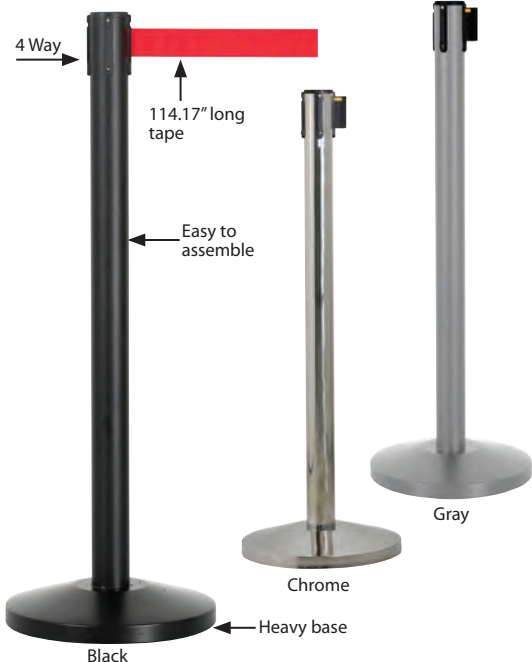

| HEADER: Acrylic | | WEIGHT | PACKING SIZE |
|-----------------|----------------------|-------------|-------------------|
| ARTICLE | DESCRIPTION | WITHPACKING | *W X H X D |
| UQBL0011A4 | Portrait, 8.5"X 11" | 1,000 kg | 245 X 335 X 75 mm |
| UQBL0012A4 | Landscape, 8.5"X 11" | 1,000 kg | 245 X 335 X 75 mm |

| HEADER: Sign Frame | | WEIGHT | PACKING SIZE |
|--------------------|--|-------------|-------------------|
| ARTICLE | DESCRIPTION | WITHPACKING | *W X H X D |
| TWBSFH0305 | Barrier Sign Frame, Horizontal, Black 8.5" X 11" | 1,500 kg | 350 X 410 X 80 mm |
| TWBSFV0305 | Barrier Sign Frame, Vertical, Black 8.5" X 11" | 1,500 kg | 260 X 490 X 80 mm |
| TWBASF0405 | Adaptor Of Sign Frame | | 80 X 130 X 85 mm |

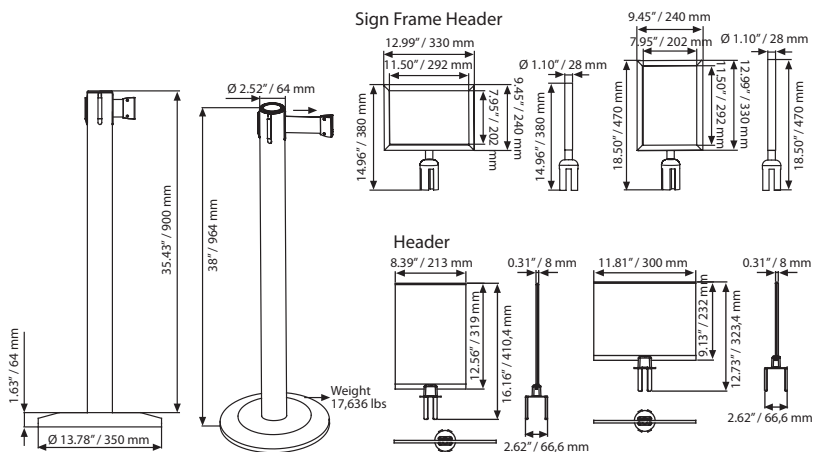

| MATERIAL : Steel post | | WEIGHT | PACKING SIZE |
|-----------------------|-------------------|-------------|--|
| ARTICLE | DESCRIPTION | WITHPACKING | *W X H X D |
| UQBL01BB00 | Black-Black Tape | 20.635 lbs | 3.94" X 38.19" X 4.92" / 15.35" X 15.35" X 2.36" |
| UQBL01BR00 | Black-Red Tape | 20.635 lbs | 3.94" X 38.19" X 4.92" / 15.35" X 15.35" X 2.36" |
| UQBL01BL00 | Black-Blue Tape | 20.635 lbs | 3.94" X 38.19" X 4.92" / 15.35" X 15.35" X 2.36" |
| UQBL01GB00 | Grey-Black Tape | 20.635 lbs | 3.94" X 38.19" X 4.92" / 15.35" X 15.35" X 2.36" |
| UQBL01GR00 | Grey-Red Tape | 20.635 lbs | 3.94" X 38.19" X 4.92" / 15.35" X 15.35" X 2.36" |
| UQBL01GL00 | Grey-Blue Tape | 20.635 lbs | 3.94" X 38.19" X 4.92" / 15.35" X 15.35" X 2.36" |
| UQBL01CB00 | Chrome-Black Tape | 20.635 lbs | 3.94" X 38.19" X 4.92" / 15.35" X 15.35" X 2.36" |
| UQBL01CR00 | Chrome-Blue Tape | 20.635 lbs | 3.94" X 38.19" X 4.92" / 15.35" X 15.35" X 2.36" |
| UQBL01CL00 | Chrome-Red Tape | 20.635 lbs | 3.94" X 38.19" X 4.92" / 15.35" X 15.35" X 2.36" |

* W:Width H: Height D: Depth



Q Belt For Wall

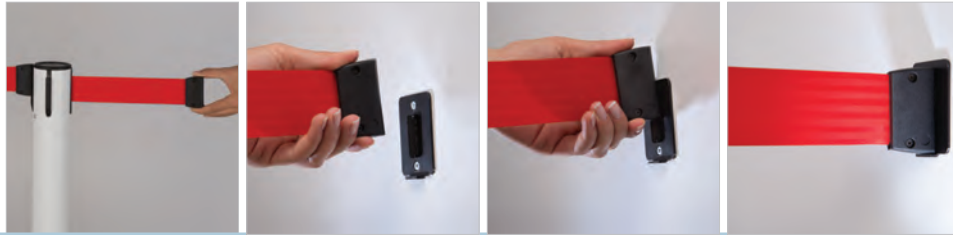



Q Belt for Wall saves space in the busy environments. Made of strong and durable plastic, it is easy to fix on the wall.

 Wall connection is supplied with screws and receiver.

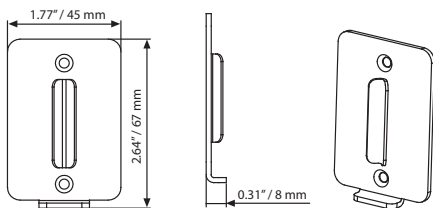
 Available only in black.



| MATERIAL : Steel | |
|------------------|-----------------------|
| ARTICLE | DESCRIPTION |
| UQBLOWC00 | Black wall connection |

Retractable Stanchion Crowd Control Posts



See movie at our website www.mtdisplays.com.tr



Made of stainless steel, Stanchion with Smart Retractable Belt has heavy decorative base. 118.11" long retractable belt has Red and Blue options. Post options are Titanium Gold or Chrome Polish. Suitable for receptions, airports, cinema and theatre ticket windows, museums and more.

118.11" tape (+/- 1.97") is available in 2 colour: Red and Blue.

Post and base is available in Silver, Chrome, Black and White.

Tape is suitable for branding in printing size of max 1.57"x106.30".

2 packs. See info chart for pack sizes.

Choice of 3 Belt colours:



Accessories available!

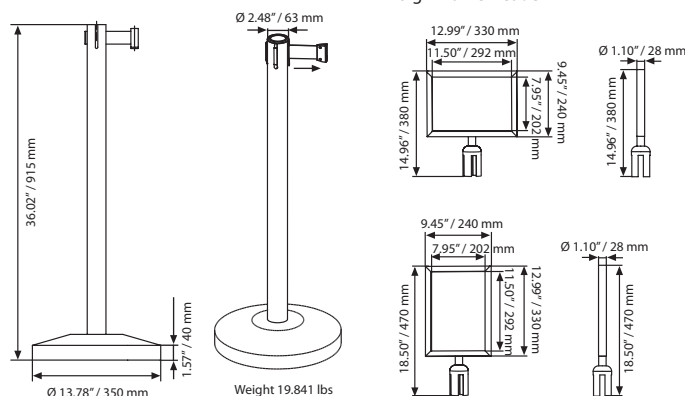
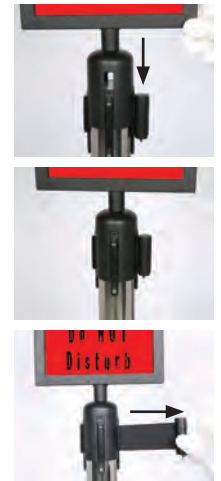

| HEADER: Sign Frame | | WEIGHT | PACKING SIZE |
|--------------------|--|-------------|-------------------------|
| ARTICLE | DESCRIPTION | WITHPACKING | *W X H X D |
| TWBSFH0305 | Barrier Sign Frame, Horizontal, Black 8.5"X11" | 3.306 lbs | 13.78" X 16.14" X 3.15" |
| TWBSFV0305 | Barrier Sign Frame, Vertical, Black 8.5"X11" | 3.306 lbs | 10.24" X 19.29" X 3.15" |
| TWBASF0405 | Adaptor Of Sign Frame | | 3.15" X 5.12" X 3.35" |

| MATERIAL : Stainless steel post | | WEIGHT | PACKING SIZE |
|---------------------------------|--|-------------|---------------------------------------|
| ARTICLE | DESCRIPTION | WITHPACKING | *W X H X D |
| TWBSTG0101 | Titanium Gold Finish - Retractable Red Belt | 9,000 kg | 90 X 1070 X 95 mm / 380 X 380 X 75 mm |
| TWBSTG0102 | Titanium Gold Finish - Retractable Blue Belt | 9,000 kg | 90 X 1070 X 95 mm / 380 X 380 X 75 mm |
| TWBSCP0101 | Chrome Polish - Retractable Red Belt | 9,000 kg | 90 X 1070 X 95 mm / 380 X 380 X 75 mm |
| TWBSCP0102 | Chrome Polish - Retractable Blue Belt | 9,000 kg | 90 X 1070 X 95 mm / 380 X 380 X 75 mm |

*W:Width H:Height D:Depth



Crowd Control Stanchion Poles & Ropes



Made of stainless steel, Crown Top Stanchion has heavy decorative base. 118.11" long twisted rope has red, blue and black options. Post options are Titanium Gold or Chrome Polish. Suitable for receptions, airports, cinema and theatre ticket windows, museums and more.

- Please order the rope individually.
- Post and base is available in titanium gold or chrome polish.
- 2 packs. See info chart for pack sizes.

Choice of 3 Belt colours:

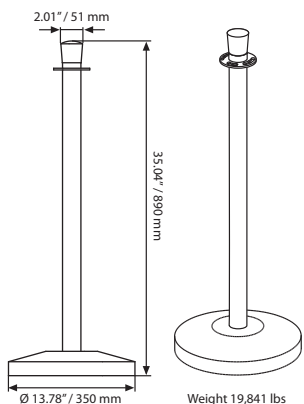
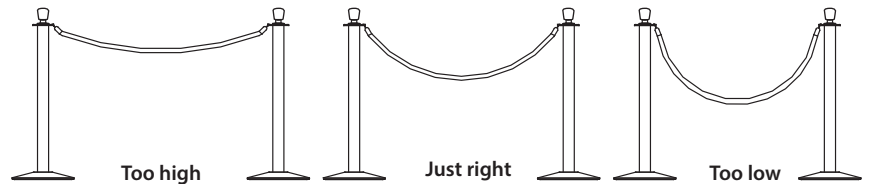
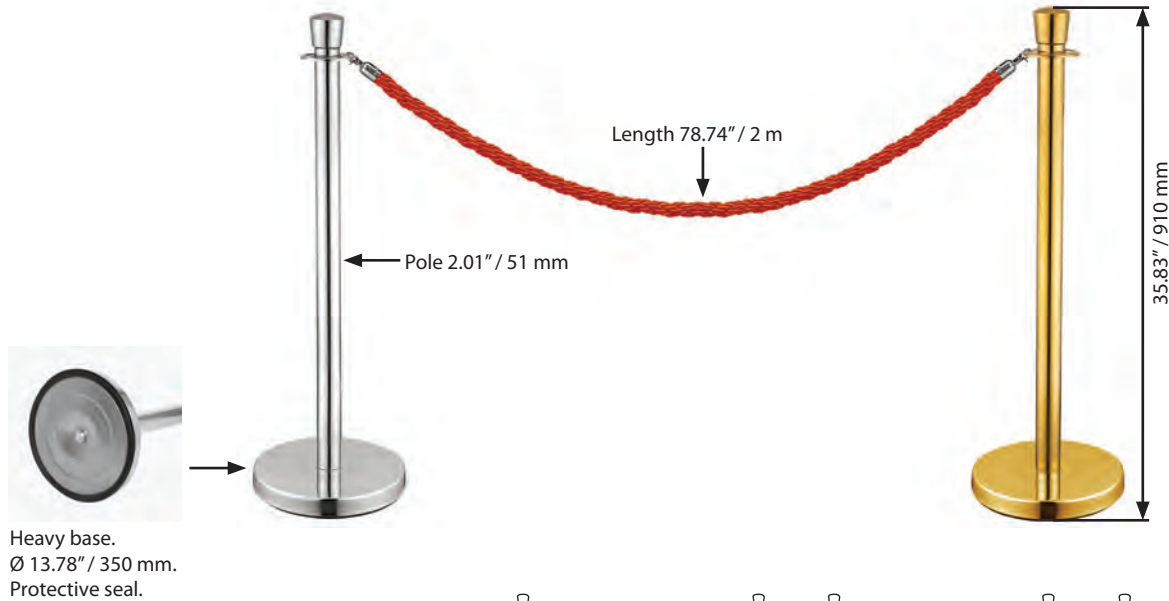

Blue-Chrome Length 78.74"



Black-Chrome Length 78.74"



Red-Chrome Length 78.74"



Red-Gold Length 118.11"

| MATERIAL : Stainless steel post | | WEIGHT | PACKING SIZE |
|---------------------------------|---|-------------|--|
| ARTICLE | DESCRIPTION | WITHPACKING | *W X H X D |
| TWBCTT05P3 | Q Rope Basic Titanium Gold Post w/out Rope | 19,841 lbs | 4.53" X 37.80" X 4.72" - 13.39" X 13.39" X 2.95" |
| TWBCTC05P4 | Q Rope Basic Chrome Polish Post w/out Rope | 19,841 lbs | 4.53" X 37.80" X 4.72" - 13.39" X 13.39" X 2.95" |
| TWBCTT05C3 | Q Rope Basic Titanium Gold Crown Top w/out Rope | 19,841 lbs | 4.53" X 37.80" X 4.72" - 13.39" X 13.39" X 2.95" |
| TWBCTC05C4 | Q Rope Basic Chrome Polish Crown Top w/out Rope | 19,841 lbs | 4.53" X 37.80" X 4.72" - 13.39" X 13.39" X 2.95" |
| TWBCTT05B3 | Q Rope Basic Titanium Gold Base w/out Rope | 19,841 lbs | 4.53" X 37.80" X 4.72" - 13.39" X 13.39" X 2.95" |
| TWBCTC05B4 | Q Rope Basic Chrome Polish Base w/out Rope | 19,841 lbs | 4.53" X 37.80" X 4.72" - 13.39" X 13.39" X 2.95" |
| UQRPOOL000 | Blue-Chrome Rope | 2,094 lbs | 4.72" X 18.11" X 3.74" |
| UQRPO0B000 | Black-Chrome Rope | 2,094 lbs | 4.72" X 18.11" X 3.74" |
| UQRPO0R000 | Red-Chrome Rope | 2,094 lbs | 4.72" X 18.11" X 3.74" |
| TWBTRT0201 | Red-Gold Rope | 3,306 lbs | 3.94" X 31.50" X 2.76" |





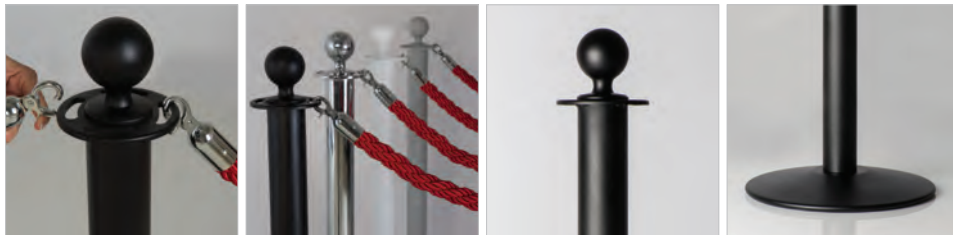

*W:Width H: Height D: Depth

Q Rope Knob Top



Strong and high quality Q Rope is ready to use. It is constructed from sturdy, durable steel. 4-way pole provides flexibility for the use. Ideal in banks, hotels, receptions, retail shops and anywhere that required a crowd management system. Contemporary finish of the pole with knob-flat-top offers differentiation. Q Rope incorporate twisted design barrier rope, which looks high quality and professional. It features with rubberized base.

-  2mt rope is available in 3 colour: Black, Red and Blue.
-  Post and base is available in Gray, Chrome, Black and White.
-  Sold as individual components.
-  2 packs. See info chart for pack sizes.

Choice of 3 Belt colours:

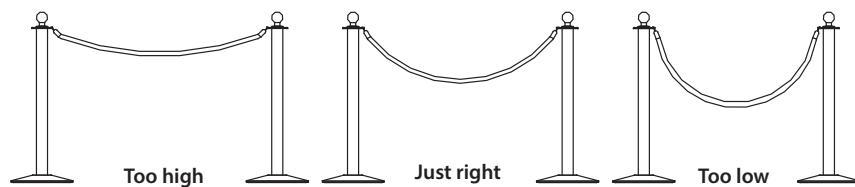
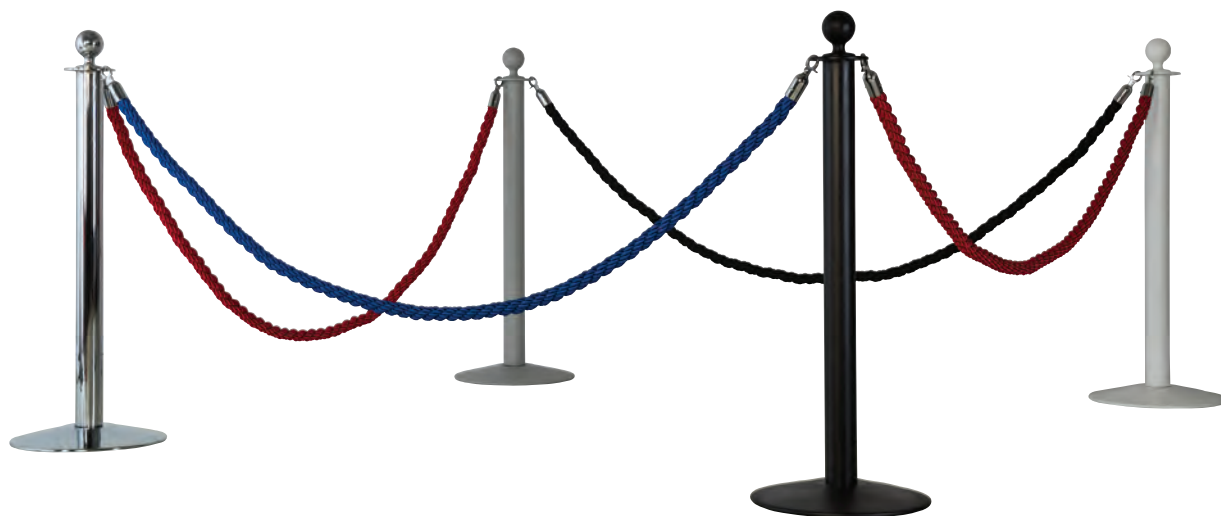

Blue-Chrome Length 78.74"
 Black-Chrome Length 78.74"
 Red-Chrome Length 78.74"
 Red-Gold Length 118.11"

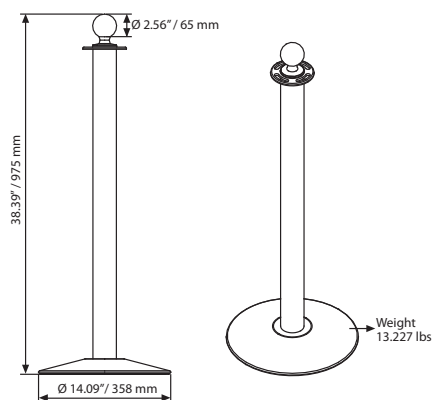

| MATERIAL : Steel | | WEIGHT | PACKING SIZE |
|------------------|--|-------------|--|
| ARTICLE | DESCRIPTION | WITHPACKING | *W X H X D |
| UQRPP1B010 | Black - Knob Top. W/out Weight W/out Rope | 13.778 lbs | 5.51" X 38.19" X 5.51" / 15.35" X 15.35" X 2.36" |
| UQRPP1G010 | Grey - Knob Top. W/out Weight W/out Rope | 13.778 lbs | 5.51" X 38.19" X 5.51" / 15.35" X 15.35" X 2.36" |
| UQRPP1C010 | Chrome - Knob Top. W/out Weight W/out Rope | 13.778 lbs | 5.51" X 38.19" X 5.51" / 15.35" X 15.35" X 2.36" |
| UQRPP1W010 | White - Knob Top. W/out Weight W/out Rope | 13.778 lbs | 5.51" X 38.19" X 5.51" / 15.35" X 15.35" X 2.36" |
| UQRPOOL000 | Blue-Chrome / only rope | 2.094 lbs | 4.72" X 18.11" X 3.74" |
| UQRPOOB000 | Black-Chrome / only rope | 2.094 lbs | 4.72" X 18.11" X 3.74" |
| UQRPOOR000 | Red-Chrome / only rope | 2.094 lbs | 4.72" X 18.11" X 3.74" |
| TWBTRT0201 | Red-Gold / only rope | 2.094 lbs | 4.72" X 18.11" X 3.74" |





* W:Width H: Height D: Depth



Q Rope Flat Top



Strong and high quality Q Rope is ready to use. It is constructed from sturdy, durable steel. 4-way pole provides flexibility for the use. Ideal in banks, hotels, receptions, retail shops and anywhere that required a crowd management system. Contemporary finish of the pole with knob-flat-top offers differentiation. Q Rope incorporate twisted design barrier rope, which looks high quality and professional. It features with rubberized base.

-  2mt rope is available in 3 colour: Black, Red and Blue.
-  Post and base is available in Gray, Chrome, Black and White.
-  Sold as individual components.
-  2 packs. See info chart for pack sizes.

Choice of 3 Belt colours:

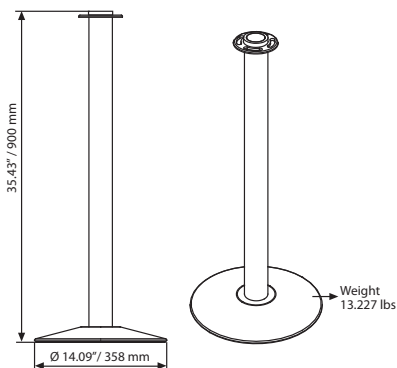
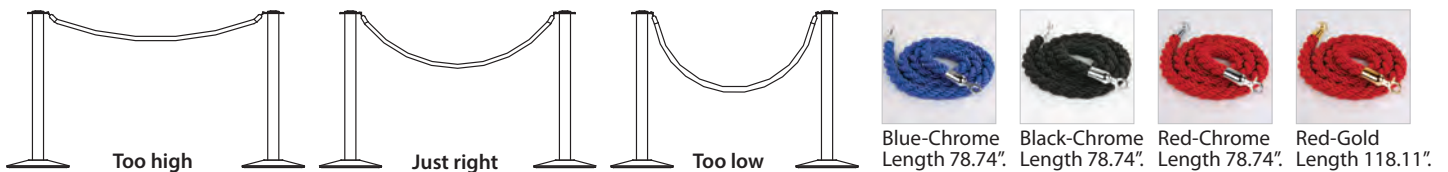

| MATERIAL : Steel | | WEIGHT | PACKING SIZE |
|------------------|--|-------------|--|
| ARTICLE | DESCRIPTION | WITHPACKING | *W X H X D |
| UQRPP1B020 | Black - Flat Top. W/out Weight W/out Rope | 13.778 lbs | 5.51" X 38.19" X 5.51" / 15.35" X 15.35" X 2.36" |
| UQRPP1G020 | Grey - Flat Top. W/out Weight W/out Rope | 13.778 lbs | 5.51" X 38.19" X 5.51" / 15.35" X 15.35" X 2.36" |
| UQRPP1C020 | Chrome - Flat Top. W/out Weight W/out Rope | 13.778 lbs | 5.51" X 38.19" X 5.51" / 15.35" X 15.35" X 2.36" |
| UQRPP1W020 | White - Flat Top. W/out Weight W/out Rope | 13.778 lbs | 5.51" X 38.19" X 5.51" / 15.35" X 15.35" X 2.36" |
| UQRP00L000 | Blue-Chrome / only rope | 2.094 lbs | 4.72" X 18.11" X 3.74" |
| UQRP00B000 | Black-Chrome / only rope | 2.094 lbs | 4.72" X 18.11" X 3.74" |
| UQRP00R000 | Red-Chrome / only rope | 2.094 lbs | 4.72" X 18.11" X 3.74" |
| TWBTRT0201 | Red-Gold / only rope | 2.094 lbs | 4.72" X 18.11" X 3.74" |

* W:Width H: Height D: Depth



Street Barrier





See movie at our website www.mtdisplays.com.tr



Large format Street Barriers create a unique space by making the advertising stand out. As it is constructed by steel, it is heavy and suitable for outdoor use. Available in 42"x24" and 65"x24" as standard.

 O rings included in the product.

 Stain free outdoor powder coating metal.

 Eye lets are not included with the product.



Included in the packed.



Unassembled feet.



8.818 lbs for each feet

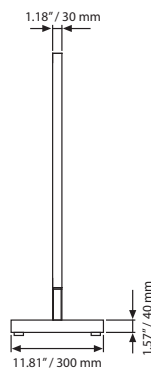
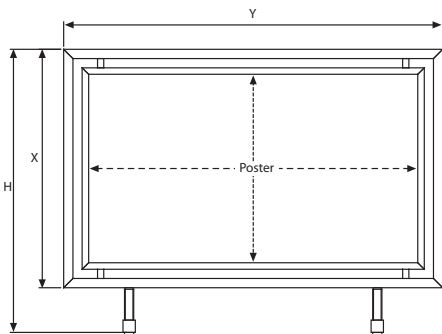

| MATERIAL : Black powder coated | | | | | | WEIGHT | PACKING SIZE |
|--------------------------------|-----------------|-----------|--------|-------------|--------------|-------------------------|--------------|
| ARTICLE | EXTERNAL (x-y) | POSTER | H | DESCRIPTION | WITH PACKING | *W X H X D | |
| UBSON00042 | 30.47" X 48.46" | 24" X 42" | 36.18" | Gray | 35.273 lbs | 37.80" X 49.61" X 1.97" | |
| UBSON00065 | 30.47" X 71.46" | 24" X 65" | 36.18" | Gray | 44.092 lbs | 37.80" X 73.23" X 1.97" | |
| UBSOB00042 | 30.47" X 48.46" | 24" X 42" | 36.18" | Black | 35.273 lbs | 37.80" X 49.61" X 1.97" | |
| UBSOB00065 | 30.47" X 71.46" | 24" X 65" | 36.18" | Black | 44.092 lbs | 37.80" X 73.23" X 1.97" | |

*W:Width H: Height D: Depth





Exhibition Displays

- Crown Truss
- Pop-up with Magnetic
- Panset
- Panset Hexagonal Counter
- Panset Convex Counter
- Midsize Convex Counter
- Foldable Wood Counter
- Pop-up Counter
- Promostand
- Seed Promostand
- Rectangular Promostand
- Circle Promostand
- Bean Promostand
- Tumble Box
- Puzzle Tumble Box
- Free Standing Puzzle Tumble Box



Crown Truss 15x15



See movie at our website www.mtdisplays.com.tr



A modular truss system with unlimited possibilities. Made in strong and durable materials - aluminium, steel and composite. At the same time it is a lightweight and foldable truss construction.

The perfect function and unique design allow the creation of custom expressions fitted to your individual needs. Very easy to assemble, disassemble, pack and carry. Available as standard models as well as parts.

3D design allows creating your own stands: www.crown3d.net

Color options



Black White

Design software is available on internet. Please ask for login details.

3 promotion packs are available; Sample Kit, Trolley Kit and Showroom Kits.

Technical data sheet available on request.



Build your own display in 3D!

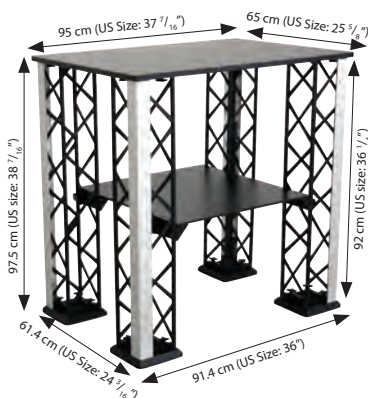

CROWN TRUSS COUNTER

| BLACK | WHITE | MODEL |
|------------|------------|---------------|
| UCT15BSP00 | UCT15WSP00 | With shelf |
| UCT15BS010 | UCT15WS010 | Without shelf |



Crown Truss Models 15x15



Model 768 / UCT15BM768

Truss L-Shape 3 x 3

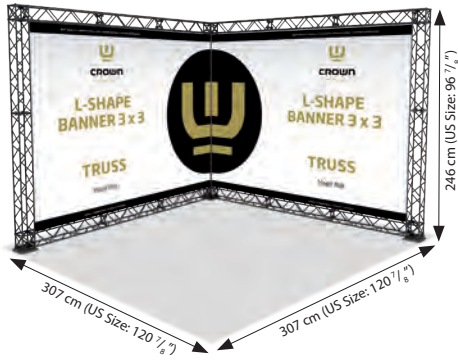

Model 771 / UCT15BM771

Truss U-Shape 4 x 4

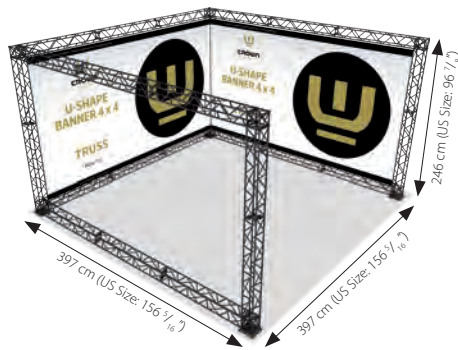

Model 772 / UCT15BM772

Truss L-Shape 5 x 5

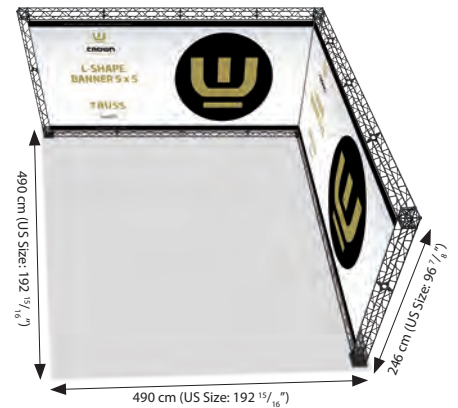

Model 775 / UCT15BM775

Truss U-Shape 4 x 6

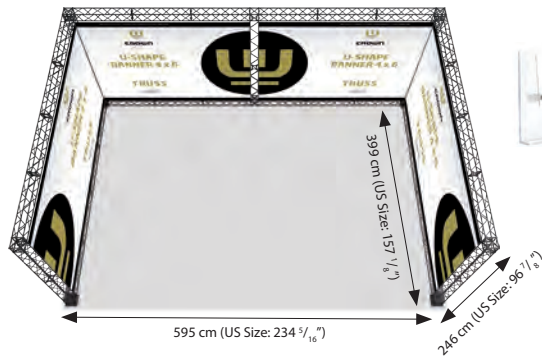

Crown Truss Parts 15x15

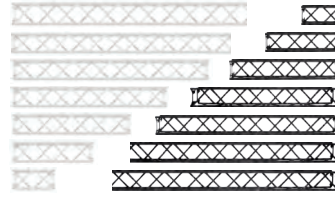

| MODULE 150X150 MM | | | WEIGHT | PACKING SIZE (5 Pcs) |
|-------------------|------------|------------------------------------|--------------|-------------------------|
| BLACK | WHITE | SIZE | WITH PACKING | *W X H X D |
| UCT15BM030 | UCT15WM030 | 11 ¹³ / ₁₆ " | 10.042 lbs | 11.22" X 12.99" X 8.27" |
| UCT15BM060 | UCT15WM060 | 23 ⁵ / ₈ " | 16.226 lbs | 11.22" X 24.80" X 8.27" |
| UCT15BM090 | UCT15WM090 | 35 ⁷ / ₁₆ " | 22.409 lbs | 11.22" X 36.61" X 8.27" |
| UCT15BM120 | UCT15WM120 | 47 ¹ / ₄ " | 28.593 lbs | 11.22" X 48.43" X 8.27" |
| UCT15BM150 | UCT15WM150 | 59 ¹ / ₁₆ " | 34.777 lbs | 11.22" X 60.24" X 8.27" |
| UCT15BM180 | UCT15WM180 | 70 ⁷ / ₈ " | 40.961 lbs | 11.22" X 72.05" X 8.27" |
| UCT15BM210 | UCT15WM210 | 82 ¹ / ₁₆ " | 47.145 lbs | 11.22" X 83.86" X 8.27" |



| REGULAR BASE | | | WEIGHT | PACKING SIZE (5 Pcs) |
|--------------|------------|---|--------------|-----------------------|
| BLACK | WHITE | SIZE | WITH PACKING | *W X H X D |
| UCT15BF220 | UCT15WF220 | 7 ¹ / ₂ " X 7 ¹ / ₂ " | 2.678 lbs | 7.87" X 7.87" X 5.91" |

| SIDE BASE | | | WEIGHT | PACKING SIZE (5 Pcs) |
|------------|------------|--|--------------|------------------------|
| BLACK | WHITE | SIZE | WITH PACKING | *W X H X D |
| UCT15BF245 | UCT15WF245 | 7 ¹ / ₂ " X 13 ⁵ / ₄ " | 4.784 lbs | 7.68" X 17.13" X 4.92" |

| MIDDLE BASE | | | WEIGHT | PACKING SIZE (5 Pcs) |
|-------------|------------|--|--------------|----------------------|
| BLACK | WHITE | SIZE | WITH PACKING | *W X H X D |
| UCT15BF260 | UCT15WF245 | 7 ¹ / ₂ " X 23 ⁵ / ₈ " | 6.613 lbs | 7.68" X 25" X 4.92" |

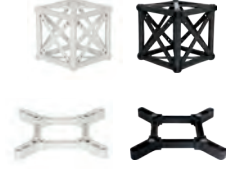

| CORNER BLOCK | | WEIGHT | PACKING SIZE (5 Pcs) |
|--------------|------------|--------------|-------------------------|
| BLACK | WHITE | WITH PACKING | *W X H X D |
| UCT15BK800 | UCT15WK800 | 11.464 lbs | 12.60" X 18.50" X 6.69" |

| CONNECTOR CROSS | | WEIGHT | PACKING SIZE (5 Pcs) |
|-----------------|------------|--------------|-----------------------|
| BLACK | WHITE | WITH PACKING | *W X H X D |
| UCT15BAE00 | UCT15WAE00 | 1.322 lbs | 6.69" X 6.69" X 3.15" |

| FOR BANNER HANGING | | WEIGHT |
|--------------------|------------------------------------|--------------|
| ARTICLE | SIZE | WITH PACKING |
| UCT15BP030 | 11 ¹³ / ₁₆ " | 6.503 lbs |
| UCT15BP060 | 23 ⁵ / ₈ " | 13.007 lbs |
| UCT15BP090 | 35 ⁷ / ₁₆ " | 19.510 lbs |
| UCT15BP120 | 47 ¹ / ₄ " | 26.014 lbs |
| UCT15BP150 | 59 ¹ / ₁₆ " | 32.518 lbs |
| UCT15BP180 | 70 ⁷ / ₈ " | 39.021 lbs |
| UCT15BP210 | 82 ¹ / ₁₆ " | 45.525 lbs |

| CLIP-ON FITTING | | WEIGHT |
|-----------------|------------|--------------|
| BLACK | WHITE | WITH PACKING |
| UCT15BBT00 | UCT15WBT00 | 2.425 lbs |



| CLIPS FOR BANNER | | | WEIGHT | PACKING SIZE (100 Pcs) |
|------------------|------------|--------------|--------------|------------------------|
| BLACK | WHITE | SIZE | WITH PACKING | *W X H X D |
| UCT15BAU00 | UCT15WAU00 | Top clips | 1.278 lbs | 5.12" X 8.07" X 4.33" |
| UCT15BAA00 | UCT15WAA00 | Bottom clips | 1.488 lbs | 5.12" X 8.07" X 4.33" |



| SHELFS | | | WEIGHT | PACKING SIZE |
|------------|------------|-----------------------------------|--------------|-------------------------|
| BLACK | WHITE | SIZE | WITH PACKING | *W X H X D |
| UCT15BR062 | UCT15WR062 | 23 ⁵ / ₈ " | 6.613 lbs | 10.43" X 24.41" X 2.76" |
| UCT15BR092 | UCT15WR092 | 35 ⁷ / ₁₆ " | 9.149 lbs | 10.43" X 36.22" X 2.76" |
| UCT15BR122 | UCT15WR122 | 47 ¹ / ₄ " | 11.684 lbs | 10.43" X 48.03" X 2.76" |
| UCT15BR152 | UCT15WR152 | 59 ¹ / ₁₆ " | 14.219 lbs | 10.43" X 59.84" X 2.76" |
| UCT15BR440 | UCT15WR440 | L Shape | 1.873 lbs | 16.34" X 16.34" X 2.76" |
| UCT15BRT00 | UCT15WRT00 | Shelf holder | 0.440 lbs | |



| ACRYLIC HOLDER | | | WEIGHT | PACKING SIZE (5 Pcs) |
|----------------|------------|---|--------------|-------------------------|
| BLACK | WHITE | SIZE | WITH PACKING | *W X H X D |
| UCT15BB0A4 | UCT15WB0A4 | 8 ¹ / ₂ " X 11" | 3.880 lbs | 10.43" X 12.01" X 9.25" |
| UCT15BB0A5 | UCT15WB0A5 | 5 ¹ / ₂ " X 8 ¹ / ₂ " | 2.491 lbs | 7.28" X 10.83" X 6.98" |
| UCT15BB0A3 | UCT15WB0A3 | 4" X 6" | 2.050 lbs | 6.98" X 6.98" X 7.28" |



| SPOTS | | WEIGHT |
|------------|-------------------------|--------------|
| ARTICLE | DESCRIPTION | WITH PACKING |
| UCT10BLT10 | Spotlight 150 W | 1.543 lbs |
| UCT15BLT00 | Spotlight fitting-Black | 0.705 lbs |
| UCT15WLT00 | Spotlight fitting-White | 0.705 lbs |



*W:Width H: Height D: Depth

Crown Truss 10x10

new

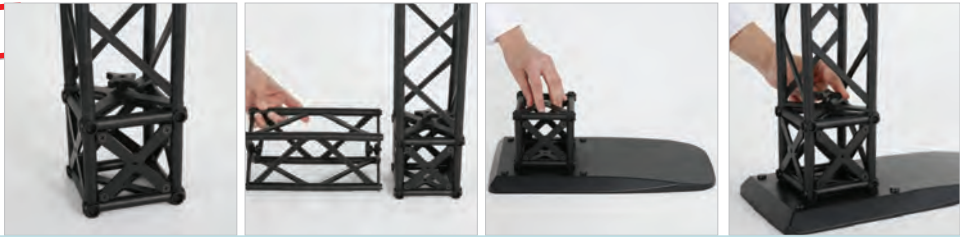

Crown Truss System 10x10 is developed for the display and exhibition industry for modular and practical advertisement purpose. It is made of strong and durable materials; aluminium, steel and composite. At the same time it is a lightweight truss construction. Very easy to assemble, disassemble, pack and carry.

 White and Black colours available.

 Technical data sheet available on request.

Color options

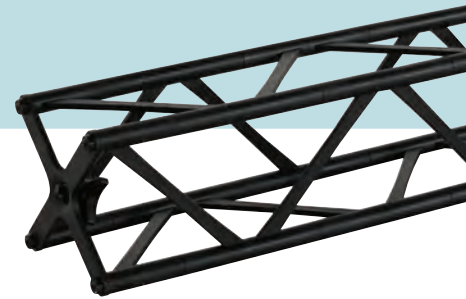

Crown Truss Parts 10x10

| MODULE 100X100 MM | | | WEIGHT | PACKING SIZE (5 Pcs) |
|-------------------|------------|---------|--------------|-------------------------|
| BLACK | WHITE | SIZE | WITH PACKING | *W X H X D |
| UCT10BM020 | UCT10WM020 | 7 7/8" | 5.996 lbs | 4.92" X 20.67" X 10.04" |
| UCT10BM040 | UCT10WM040 | 15 3/4" | 8.708 lbs | 4.92" X 20.67" X 17.91" |
| UCT10BM060 | UCT10WM060 | 23 5/8" | 11.464 lbs | 4.92" X 20.67" X 25.79" |
| UCT10BM080 | UCT10WM080 | 31 1/2" | 14.219 lbs | 4.92" X 20.67" X 33.66" |
| UCT10BM100 | UCT10WM100 | 39 3/8" | 16.755 lbs | 4.92" X 20.67" X 41.54" |
| UCT10BM120 | UCT10WM120 | 47 1/4" | 19.731 lbs | 4.92" X 20.67" X 49.41" |
| UCT10BM140 | UCT10WM140 | 55 1/8" | 22.487 lbs | 4.92" X 20.67" X 57.28" |
| UCT10BM160 | UCT10WM160 | 63" | 25.132 lbs | 4.92" X 20.67" X 65.16" |
| UCT10BM180 | UCT10WM180 | 70 7/8" | 27.888 lbs | 4.92" X 20.67" X 73.03" |
| UCT10BM200 | UCT10WM200 | 78 3/4" | 30.644 lbs | 4.92" X 20.67" X 80.91" |

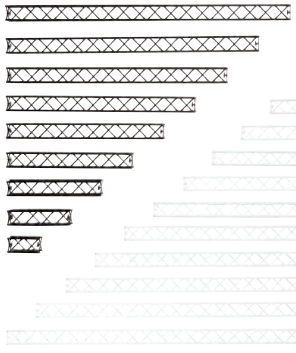

| CORNER BLOCK | | WEIGHT | PACKING SIZE (5 Pcs) |
|--------------|-----------|--------------|------------------------|
| BLACK | WHITE | WITH PACKING | *W X H X D |
| UCT10BK00 | UCT10WK00 | 7.517 lbs | 4.92" X 4.92" X 21.85" |

| CONNECTOR CROSS (5 Pcs) | | WEIGHT | PACKING SIZE (5 Pcs) |
|-------------------------|------------|--------------|-----------------------|
| BLACK | WHITE | WITH PACKING | *W X H X D |
| UCT10BAE00 | UCT10WAE00 | 0.705 lbs | 4.92" X 4.92" X 4.13" |

| FOR BANNER HANGING | | WEIGHT |
|--------------------|---------|--------------|
| ARTICLE | SIZE | WITH PACKING |
| UCT10BP020 | 7 7/8" | 0.440 lbs |
| UCT10BP040 | 15 3/4" | 0.881 lbs |
| UCT10BP060 | 31 1/2" | 1.752 lbs |
| UCT10BP080 | 39 3/8" | 2.182 lbs |
| UCT10BP120 | 55 1/8" | 3.064 lbs |
| UCT10BP150 | 63" | 3.494 lbs |
| UCT10BP180 | 78 3/4" | 4.365 lbs |

| REGULAR BASE | | | WEIGHT | PACKING SIZE (5 Pcs) |
|--------------|------------|-----------------|--------------|-----------------------|
| BLACK | WHITE | SIZE | WITH PACKING | *W X H X D |
| UCT10BF220 | UCT10WF220 | 7 1/2" X 7 1/2" | 2.910 lbs | 8.07" X 8.07" X 6.10" |



| SIDE BASE | | | WEIGHT | PACKING SIZE (5 Pcs) |
|------------|------------|------------------|--------------|------------------------|
| BLACK | WHITE | SIZE | WITH PACKING | *W X H X D |
| UCT10BF245 | UCT10WF245 | 7 1/2" X 15 3/4" | 4.784 lbs | 7.68" X 17.13" X 4.92" |



| MIDDLE BASE | | | WEIGHT | PACKING SIZE (5 Pcs) |
|-------------|------------|------------------|--------------|----------------------|
| BLACK | WHITE | SIZE | WITH PACKING | *W X H X D |
| UCT10BF260 | UCT10WF245 | 7 1/2" X 23 5/8" | 6.613 lbs | 7.68" X 25" X 4.92" |



| ACRYLIC HOLDER | | | WEIGHT | PACKING SIZE (5 Pcs) |
|----------------|------------|-----------------|--------------|-------------------------|
| BLACK | WHITE | SIZE | WITH PACKING | *W X H X D |
| UCT10BB0A4 | UCT10WB0A4 | 8 1/2" X 11" | 3.880 lbs | 10.43" X 12.01" X 9.25" |
| UCT10BB0A5 | UCT10WB0A5 | 5 1/2" X 8 1/2" | 2.491 lbs | 7.28" X 10.83" X 6.98" |
| UCT10BB0A3 | UCT10WB0A3 | 4" X 6" | 2.050 lbs | 6.98" X 6.98" X 7.28" |



| CLIP-ON FITTING | | WEIGHT |
|-----------------|------------|--------------|
| BLACK | WHITE | WITH PACKING |
| UCT10BBT00 | UCT10WBT00 | 2.425 lbs |



| CLIPS FOR BANNER | | | WEIGHT | PACKING SIZE (100 Pcs) |
|------------------|------------|--------------|--------------|------------------------|
| BLACK | WHITE | SIZE | WITH PACKING | *W X H X D |
| UCT10BAU00 | UCT10WAU00 | Top clips | 1.278 lbs | 5.12" X 8.07" X 4.33" |
| UCT10BAA00 | UCT10WAA00 | Bottom clips | 1.488 lbs | 5.12" X 8.07" X 4.33" |

| SPOTS | | WEIGHT |
|-------------|-------------------------|--------------|
| ARTICLE | DESCRIPTION | WITH PACKING |
| UCT10BLT10 | Spotlight 150 W | 1.543 lbs |
| UCT10BLI00 | Spotlight fitting-Black | 0.705 lbs |
| UCT10WLIT00 | Spotlight fitting-White | 0.705 lbs |

*W:Width H:Height D:Depth



Panset



Panset exhibition system is a portable & friendly assembled panel construction. The durable framework of Panset can be positioned between 0-360° The framework of the construction can be easily unassembled to permit a quick change of the panel inside. The Poster can easily change by laminating. Panset systems have a variety of sizes 3X3,3X4,3x5. Panset black carry bag main body for all size is available.

Application of the inner panels
Open the top profiles by using an allen key. Take out the unprinted panels. After the application of the printings on the panels, slide them into the construction through the channels on both sides. Fix the top profiles in the side channels as shown in the photo. Use the allen key to firm the positioning of profiles. Repeat the same process for all the panels. Fix the header panels on the second floor panels first. On last step place in the bottom floor with the top part. Here is the complete Exhibition stand.

 Please consider during planning that the visual area of the graphic panel will diminish by 0,5 cm on every side because of the profile covering.

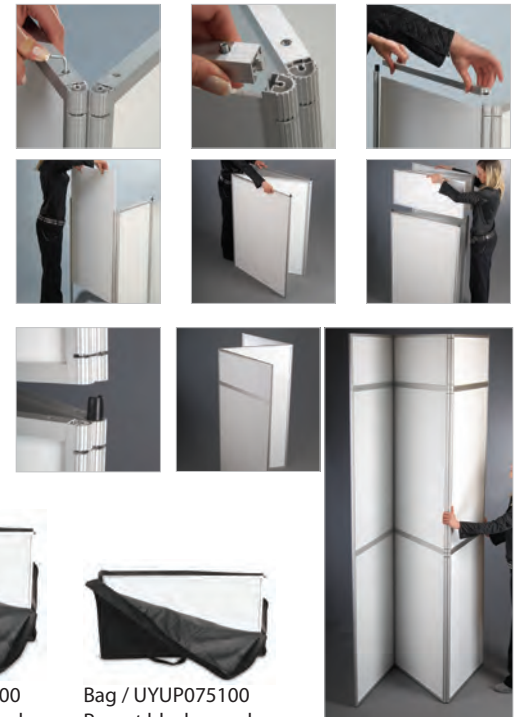

Bag / UYUP076100
Panset black carry bag main body for all size. Don't forget to order.



Bag / UYUP075100
Panset black carry bag for logo for all size. Don't forget to order.

3x5 / 3x4 / 3x3 Panset

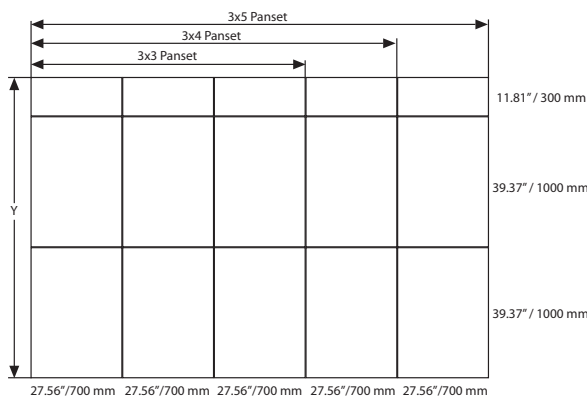

| MATERIAL : Silver anodised aluminium PANEL: Plastech PVC Foam | | | | WEIGHT | PACKING SIZE |
|---|------------------|-----------------|-----------------|--------------|-------------------------|
| ARTICLE | EXTERNAL (x-y) | PANEL | HEADER | WITH PACKING | *W X H X D |
| UPNS000035 | 137.80" X 90.55" | 27.56" X 39.37" | 11.81" X 27.56" | 79.256 lbs | 13.78" X 29.92" X 5.51" |
| | | | | | 13.78" X 44.09" X 5.51" |
| | | | | | 13.78" X 44.09" X 5.51" |
| UPNS000034 | 110.24" X 90.55" | 27.56" X 39.37" | 11.81" X 27.56" | 65.102 lbs | 13.78" X 29.92" X 4.72" |
| | | | | | 13.78" X 44.09" X 4.72" |
| | | | | | 13.78" X 44.09" X 4.72" |
| UPNS000033 | 82.68" X 90.55" | 27.56" X 39.37" | 11.81" X 27.56" | 49.956 lbs | 13.78" X 29.92" X 3.15" |
| | | | | | 13.78" X 44.09" X 3.15" |
| | | | | | 13.78" X 44.09" X 3.15" |



*W:Width H: Height D: Depth



Pop-up with Magnetic



Pop-up stands with clips or magnetic are still the most popular standard display for large graphic displays. They are easy to transport, light weight, simple pop-ups and packable into a roto-molded plastic carry bag for transportation. Pop-up displays have a variety of sizes 3x3, 3x4. Panels are fitted to create a round display. Lights are available upon request.

-  Product is packed unassembled.
-  Simple pop-ups, no tool assembly.
-  Lighting equipment is optional, not included in the original pack.



Light / UYUP367130

3x4 Printing Panel Sizes

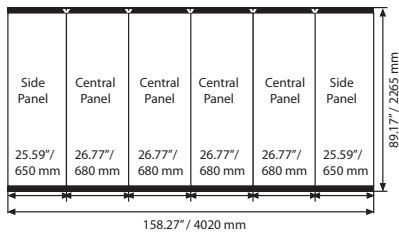

3x3 Printing Panel Sizes

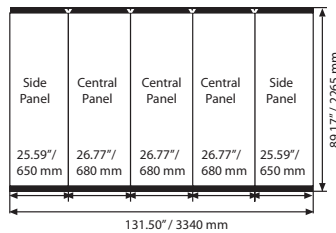

| MATERIAL : Aluminium | | WEIGHT | PACKING SIZE |
|----------------------|----------------------------------|--------------|--------------------------|
| ARTICLE | MODEL | WITH PACKING | *W X H X D |
| UPPC220033 | Pop Up 3x3 (with Bag) | 64.110 lbs | 16.14" X 36.22" X 23.62" |
| UPPC220034 | Pop Up 3x4 (with Bag) | 77.823 lbs | 16.14" X 36.22" X 23.62" |
| UPPC230033 | Pop Up 3x3 (with Bag & Lighting) | 67.505 lbs | 16.14" X 36.22" X 23.62" |
| UPPC230034 | Pop Up 3x4 (with Bag & Lighting) | 77.823 lbs | 16.14" X 36.22" X 23.62" |

| MATERIAL : Aluminium | | | | | | | | | | WEIGHT | PACKING SIZE | | |
|----------------------|-------|-----------------|----------|-----------------|----------|------------------------|----------|------------------------|----------|--------------|-------------------|--------------|--------------------------|
| ARTICLE | MODEL | PVC PANEL | | | | HOLDER | | | | MAGNETIC BAR | MAGNETIC STRIPES | WITH PACKING | *W X H X D |
| | | CENTRAL | QUANTITY | SIDE | QUANTITY | CENTRAL | QUANTITY | SIDE | QUANTITY | | | | |
| UPPC200033 | 3 X 3 | 26.77" X 89.17" | 3 | 25.59" X 89.17" | 2 | 26.77" X 2.20" X 0.08" | 6 | 25.59" X 2.20" X 0.03" | 4 | 1 set 18 pcs | 1181.10" (1 rulo) | 48.832 lbs | 16.54" X 33.86" X 16.54" |
| UPPC200034 | 3 X 4 | 26.77" X 89.17" | 4 | 25.59" X 89.17" | 2 | 26.77" X 2.20" X 0.08" | 8 | 25.59" X 2.20" X 0.03" | 4 | 1 set 21 pcs | 1181.10" (1 rulo) | 55.115 lbs | 16.54" X 33.86" X 16.54" |

* W:Width H: Height D: Depth



Pop-up Assembly

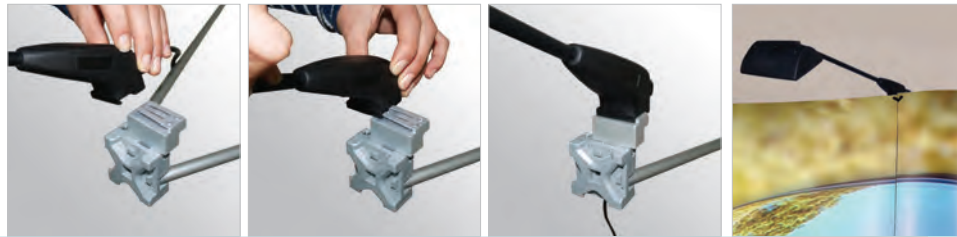

Slide the light properly into the spot ready on the top of the main construction. Please note that this optional item is not supplied with the pop-ups. If need be, 2 of lights come with 3x3 and 3 off lights come with 3x4.

Caution:

After the printing is applied on the black PVC panels, the brut sizes should be cut & resized to net panel sizes using at least trimming knives.

The system is suitable for 2 lights in 3x3 and 3 lights in 3x4.

This pack includes; Pop-up 3x3



1 x Pop-up Wall Magnetic.



18 x Bars with magnetic tape inside its textile bag.



1 x Roll self adhesive magnetic tape.



2 x Black PVC (Magnetic: Brut:27.17"x90.94"x0.02"
Net:25.59"x89.17"x0.02")
3 x Black PVC (Magnetic: Brut:28.74"x90.94"x0.02"
Net:26.77"x89.17"x0.02")



2 x Hanging straps with slot (25.59"x2.20"x0.03")
2 x Simple straps (27.17"x2.20"x0.03")



3 x Hanging straps with slot (26.77"x2.20"x0.08")
3 x Simple straps (26.77"x2.20"x0.08")



2 x Hanging straps with magnet (25.59"x2.20"x0.03")
2 x Simple straps (25.59"x2.20"x0.03")



2 x Hanging straps with magnet (25.59"x2.20"x0.03")
2 x Simple straps (25.59"x2.20"x0.03")



2 x Lights when it is required.

This pack includes; Pop-up 3x4



1 x Pop-up Wall Magnetic.



21 x Bars with magnetic tape inside its textile bag.



1 x Roll self adhesive magnetic tape.



2 x Black PVC (Magnetic: Brut:27.17"x90.94"x0.02"
Net:25.59"x89.17"x0.02")
4 x Black PVC (Magnetic: Brut:28.74"x90.94"x0.02"
Net:26.77"x89.17"x0.02")



2 x Hanging straps with slot (25.59"x2.20"x0.03")
2 x Simple straps (27.17"x2.20"x0.03")



4 x Hanging straps with slot (26.77"x2.20"x0.08")
4 x Simple straps (26.77"x2.20"x0.08")



2 x Hanging straps with magnet (25.59"x2.20"x0.03")
2 x Simple straps (25.59"x2.20"x0.03")



4 x Hanging straps with magnet (25.59"x2.20"x0.03")
4 x Simple straps (25.59"x2.20"x0.03")





3 x Lights when it is required.

Panset Hexagonal Counter



Panset counters are ideal products with a light & compact structure. They can be carried to different locations and re-used many times. It is easy and quick to install. Different models meet your needs in the most convenient manner. These counters are lightweight and fit quickly in the corner of a car.

 After the panels are assembled, due to the fitting of panels inside the construction, the visual area is 0,5 cm smaller on all sides.

 Please first fix the shelf and then the top plate. Black textile carry bag is optional.



Max. carriage capacity
55.115lbs



Max. carriage capacity
22.046 lbs



Transport bag / UYUP074100

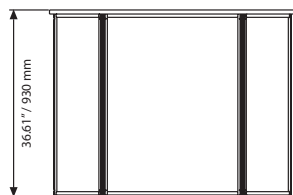
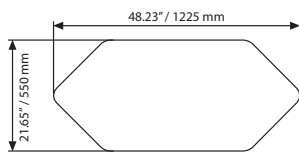

| MATERIAL : Silver anodised aluminium PANEL: Plastech PVC Foam | | | | WEIGHT | PACKING SIZE |
|--|----------------|-----------------|----------|--------------|----------------------|
| ARTICLE | MODEL | PANEL | QUANTITY | WITH PACKING | *W X H X D |
| UPSM001000 | Hexagonal | 34.57" X 25.94" | 1 | 42,549 lbs | 28.35" X 50" X 5.12" |
| | | 34.57" X 12.24" | 4 | | |
| UPSM007000 | Wood Hexagonal | 34.57" X 25.94" | 1 | 46,958 lbs | 28.35" X 50" X 5.12" |
| | | 34.57" X 12.24" | 4 | | |





* W:Width H: Height D: Depth

Panset Convex Counters



Panset counters are ideal products of light & compact structure, they can be carried to different locations and re-used many times. It is easy and fast in assembly. Different models offer you the most convenient choice for your needs. These lightweight counters fit quickly in the corner of a car.

 After the panels are assembled, due to the fitting of panels inside the construction, the visual area is 0,5 cm smaller on all sides.

 Please first fix the shelf and then the top plate. Black textile carry bag is optional.

Convex Counter



Max. carriage capacity 33.069 lbs

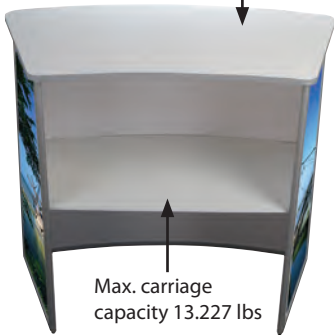

Max. carriage capacity 13.227 lbs

Wood Convex Counter



Max. carriage capacity 44.092 lbs

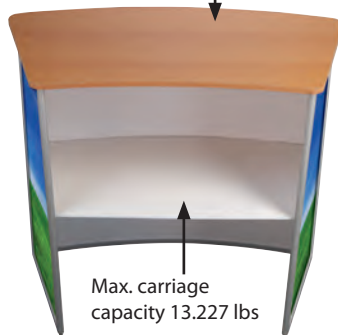

Max. carriage capacity 13.227 lbs

Midsize Convex Counter



Max. carriage capacity 33.069 lbs



Max. carriage capacity 13.227 lbs



Transport bag / UYUP074000



Transport bag / UYUP070200

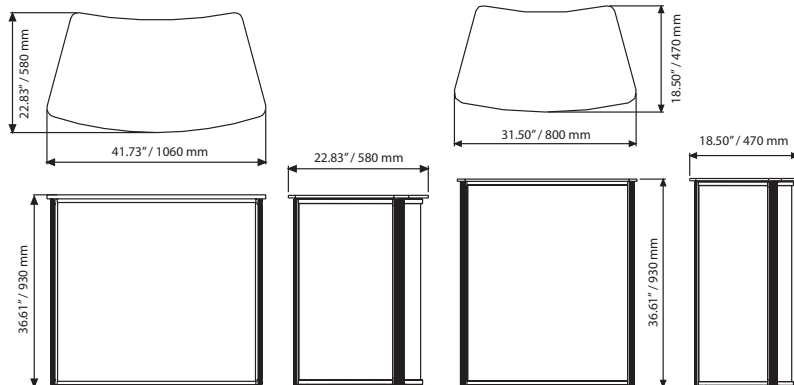

| MIDSIZE COUNTER : Silver anodised aluminium PANEL: Plastech PVC Foam | | | WEIGHT | PACKING SIZE |
|--|-----------------|----------|--------------|-------------------------|
| ARTICLE | PANEL | QUANTITY | WITH PACKING | *W X H X D |
| UPSM052000 | 28.2" X 34.57" | 1 | 39.903 lbs | 37.40" X 46.46" X 5.51" |
| | 13.19" X 34.57" | 2 | | |

| CONVEX COUNTER : Silver anodised aluminium PANEL: Plastech PVC Foam | | | | WEIGHT | PACKING SIZE |
|---|-------------|-----------------|----------|--------------|-------------------------|
| ARTICLE | MODEL | PANEL | QUANTITY | WITH PACKING | *W X H X D |
| UPSM002000 | Convex | 34.57" X 38.58" | 1 | 44.312 lbs | 37.40" X 46.46" X 5.51" |
| | | 34.57" X 16.93" | 2 | | |
| UPSM008000 | Wood Convex | 34.57" X 38.58" | 1 | 44.423 lbs | 37.40" X 46.46" X 5.51" |
| | | 34.57" X 16.93" | 2 | | |



*W:Width H: Height D: Depth

Foldable Wood Counter



Foldable Wood Counter is compact and easy carry counter desk suitable for exhibitions, demonstrations and other kinds of presentation with 3 holders for 2x4 brochures. It is made of steel and hard MDF. Locking system ensures safe use. Heavy steel base provides stability. The counter comes ready to use with optional carry bag and folds flat for easy transportation.

The counter comes ready to use with an easy-to-understand instruction sheet.

Flat folded and flat packed.

Optional carry bag.

1 pack. See info chart for pack sizes.

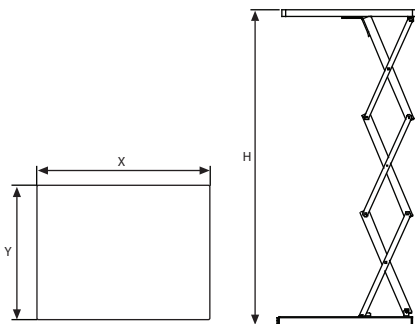
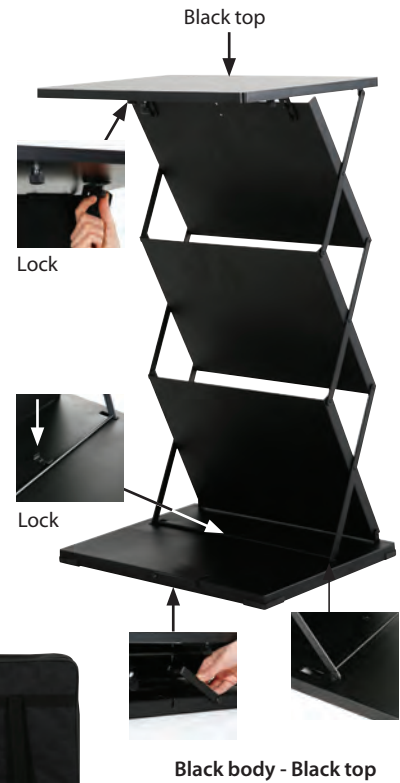

| MATERIAL: Sheet metal & wood | | | | | | WEIGHT | PACKING SIZE (5 Pcs) |
|------------------------------|-----------------|----------------|--------|--------|-------------------------------------|--------------|-----------------------|
| ARTICLE | SIZE (x-y) | CAPACITY | H max. | H min. | DESCRIPTION | WITH PACKING | *W X H X D |
| UWFC1B0324 | 20.47" X 15.75" | 2 X (8.5"X11") | 36.42" | 5.31" | Black body - Black top | 2.910 lbs | 8.07" X 8.07" X 6.10" |
| UWFC1B1324 | 20.47" X 15.75" | 2 X (8.5"X11") | 36.42" | 5.31" | Black body - Black top with bag | | |
| UWFC1D0324 | 20.47" X 15.75" | 2 X (8.5"X11") | 36.42" | 5.31" | Black body - Dark wood top | | |
| UWFC1D1324 | 20.47" X 15.75" | 2 X (8.5"X11") | 36.42" | 5.31" | Black body - Dark wood top with bag | | |
| UWFC2B0324 | 20.47" X 15.75" | 2 X (8.5"X11") | 36.42" | 5.31" | Silver body - Black top | | |
| UWFC2B1324 | 20.47" X 15.75" | 2 X (8.5"X11") | 36.42" | 5.31" | Silver body - Black top with bag | | |
| UWFC2D0324 | 20.47" X 15.75" | 2 X (8.5"X11") | 36.42" | 5.31" | Silver body-Dark wood top | | |
| UWFC2D1324 | 20.47" X 15.75" | 2 X (8.5"X11") | 36.42" | 5.31" | Silver body -Dark wood top with bag | | |

*W:Width H: Height D: Depth



Pop-up Counter



The pop-up counter offers an easy low-budget solution that can be carried to various locations and even re-used after many events. The counter can pop up in a second with no tools required.

When we put the panel on the bag, the panel ends will overlap each other by 20 mm.

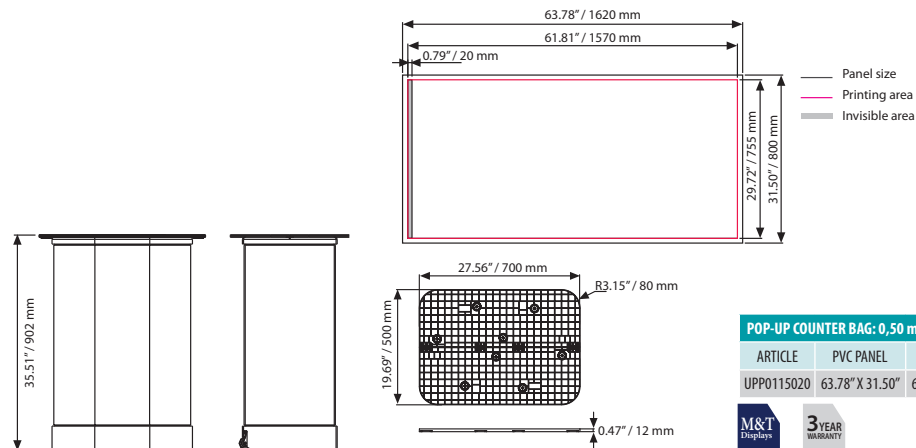

| POP-UP COUNTER BAG: 0,50 mm, black PVC panel | | | | | WEIGHT | PACKING SIZE |
|--|-----------------|-----------------|-----------------|--------------|--------------|--------------------------|
| ARTICLE | PVC PANEL | COPY SIZE | TOP PLATE | MAGNETIC BAR | WITH PACKING | *W X H X D |
| UPP0115020 | 63.78" X 31.50" | 61.02" X 29.72" | 27.56" X 19.69" | 1 Pcs | 28.682 lbs | 16.54" X 36.22" X 23.62" |



*W:Width H: Height D: Depth

Promostand



This simple counter is suitable for exhibitions, demonstrations and other kinds of presentation. Produced in white plastic material, ready for any kind of decoration. Foldable and easy to transport and mount. Delivered with or without carry bag. We use powder coated steel pipes to hold 0.12" thick header panel made of Plastech PVC foam.

Product is packed unassembled with an easy-to-understand instruction sheet.

After the front panel is assembled due to fitting of panels inside the plastic construction, the visual area is 1.50" smaller on top & bottom ends. Thickness of front panel is 0.12". Thickness of counter & shelves is 0.12".

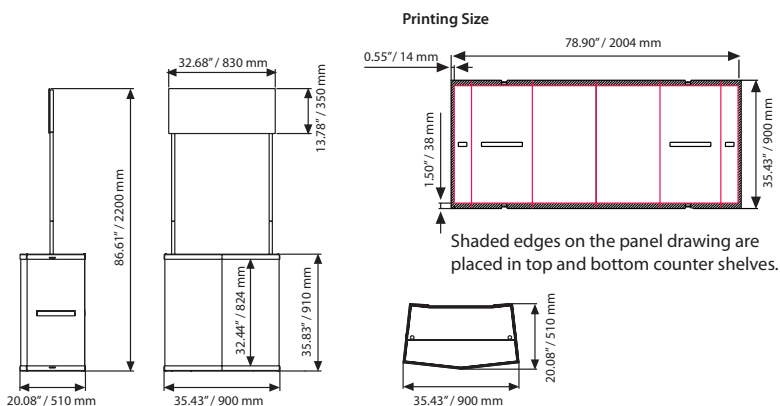

| MATERIAL : Plastic | | | | WEIGHT | PACKING SIZE |
|--------------------|-------------|-----------------|-----------------|--------------|-------------------------|
| ARTICLE | DESCRIPTION | PANEL SIZE | COPY SIZE | WITH PACKING | *W X H X D |
| UTSOON5000 | Without bag | 78.90" X 35.43" | 78.43" X 32.44" | 29.982 lbs | 21.65" X 37.40" X 6.30" |
| UTSOON5100 | With bag | 78.90" X 35.43" | 78.43" X 32.44" | 31,085 lbs | 21.65" X 37.40" X 6.30" |



*W:Width H: Height D: Depth





Seed Promostand



See movie at our website www.mtdisplays.com.tr



Seed Promostand is suitable for all kind of promotion events for retail promotions such as exhibitions, supermarkets, demonstrations. With its unique seed shape, it takes attention and occupies small place where it stands. Seed Promostand is a stock saving product. Ledge Seed Promostand that gives more space for item promoted. Header Seed Promostand allows for personalizing. Seed Promostand with Pole System offers choice of shelves, banners, and header. Also offered with a choice of felt fabric in grey.

-  Packed unassembled with an easy-to-understand instruction sheet.
-  Flat - pack design.
-  Inner shelf, header, carry bag, brochure holders excluded. See Free Standing System pages for more accessory options.
-  2 packs. See info chart for pack sizes.

Don't forget to order separately

- Inner shelf
- Grey felt
- Carry bag
- Header
- Ledge

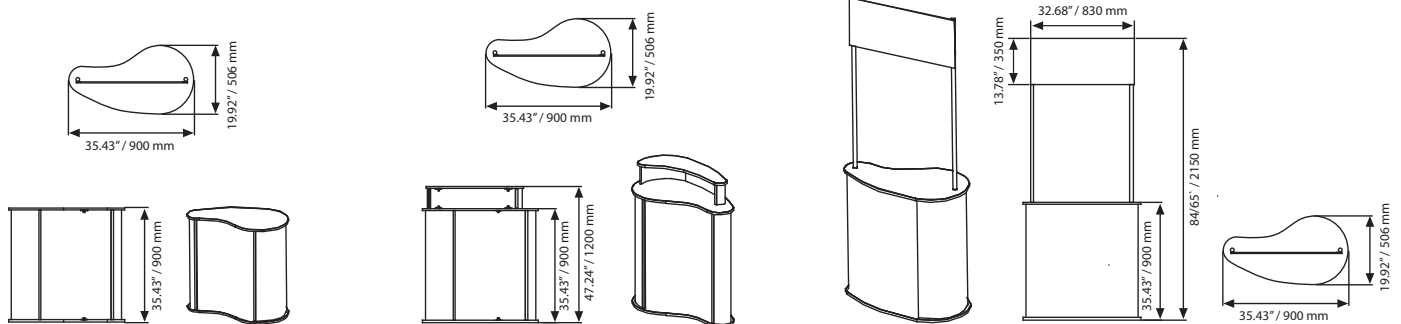



See movie at our website www.mtdisplays.com.tr

Seed Ledge Promostand

- Hard white top plate.
- Max. carriage capacity 154.323 lbs



- Hard white top plate.
- Max. carriage capacity 154.323 lbs



Max. carriage capacity 66.138 lbs



UYPOTS0030
Velcro Roll with double sided tape 59 ft.



UYPOTSC03G
Grey felt only for Seed Promostand incl. Velcro set for 35.43"



See movie at our website www.mtdisplays.com.tr

Seed Promostand with Header

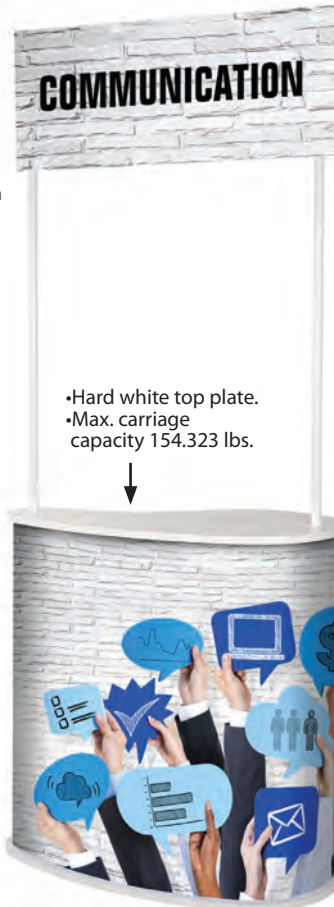

- Hard white top plate.
- Max. carriage capacity 154.323 lbs.



UYPOTS1050
Carry bag

0.12" / 3 mm
PVC Foam.

Don't forget to order separately

- Inner shelf
- Grey felt
- Carry bag
- Header
- Ledge



Strong & elegant powder coated steel pipes.

Max. carriage capacity 66.138 lbs.

| MATERIAL : Plastic | | | | WEIGHT | PACKING SIZE |
|--------------------|--|-----------------|-----------------|--------------|--|
| ARTICLE | DESCRIPTION | PANEL SIZE | PRINTING SIZE | WITH PACKING | *W X H X D |
| UTSC00909 | w/out bag,w/out felt,w/out shelf | 60.24" X 35.12" | 58.90" X 34.06" | 18.077 lbs | 21.06" X 37.01" X 2.76" / 7.87" X 37.01" X 7.87" |
| UTSC020909 | with header,w/out bag,w/out felt,w/out shelf | 60.24" X 35.12" | 58.90" X 34.06" | 24.250 lbs | 21.06" X 37.01" X 3.74" / 7.87" X 48.82" X 7.87" |
| UTSC010912 | Ledge w/out bag,w/out felt,w/out shelf | 60.24" X 35.12" | 58.90" X 34.06" | 20.943 lbs | 22.44" X 40.94" X 3.74" / 7.87" X 37.01" X 7.87" |
| UYPOTSC010 | Inner shelf only,white | 33.46" X 17.48" | | 2.204 lbs | 33.66" X 17.68" X 0.28" |
| UYPOTSC020 | Inner shelf only for header ,white | 33.46" X 17.48" | | 2.204 lbs | 33.66" X 17.68" X 0.28" |
| UYPOTSC03G | Grey felt only incl.Velcro. | 61.42" X 34.06" | 61.42" X 34.06" | 0.749 lbs | 9.84" X 9.84" X 3.94" |
| UTSC030909 | Pole system,w/out bag or felt or shelf or header | 61.30" X 35.12" | 59.96" X 34.06" | 23.809 lbs | 21.06" X 37.01" X 2.76" / 8.07" X 51.97" X 5.71" |
| UYPOTSC040 | Header only for pole system | 13.78" X 19.69" | 13.78" X 19.69" | 1.102 lbs | 12.60" X 20.08" X 1.18" |
| UYPOTSP010 | Inner shelf only for pole system,White | 34.37" X 17.48" | | 2.535 lbs | 34.57" X 17.68" X 0.28" |
| UYPOTSP03G | Grey felt only for pole system incl.Velcro | 62.32" X 34.06" | 62.32" X 34.06" | 0.771 lbs | 9.84" X 9.84" X 3.94" |

*W:Width H: Height D: Depth



Variations & Seed Promostand with Pole System



See movie at our website www.mtdisplays.com.tr

Make up movie your stand to fit your own wishes!



Mix and match your own stand!

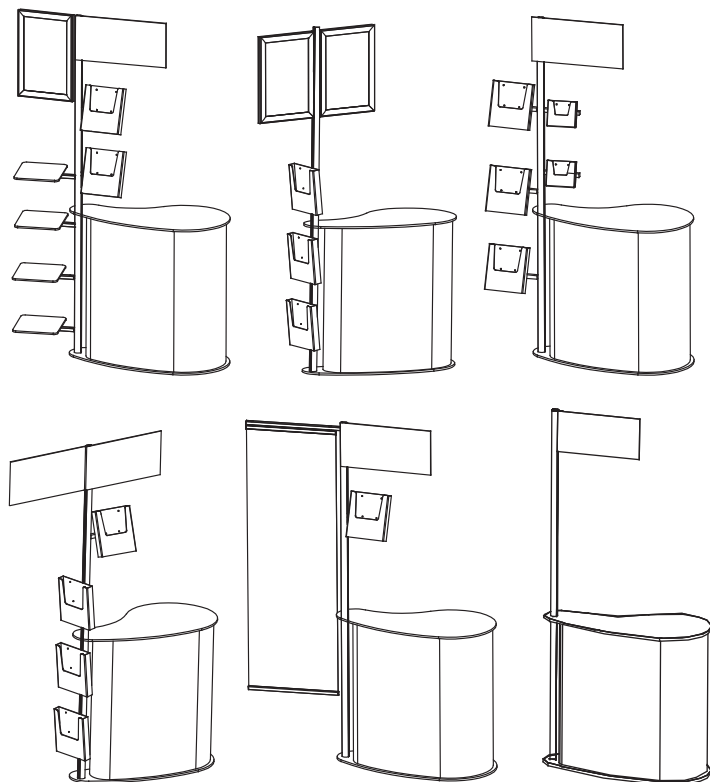

Don't forget to order separately

- Inner shelf
- Grey felt
- Carry bag
- Header
- Ladder
- Circle & square shelves
- Leaflet holders
- Slide-in frames
- Banner holder

UYPOTS0030
Velcro Roll with double sided tape 59 ft.

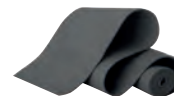

UYPOTSP03G
Grey felt only for Seed Promostand with Pole System incl. Velcro set for 35.43\"/>



UYPOTS2050 / Carry bag

Acrylic Shelf 8.5\"/>

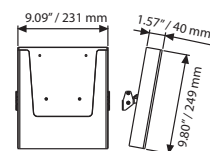

MDF Shelf Circle
UFSL002500

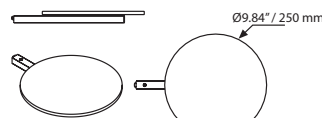

MDF Shelf Square
UFSL002510

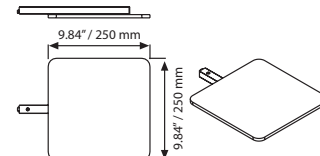

Rectangular Promostand



See movie at our website www.mtdisplays.com.tr

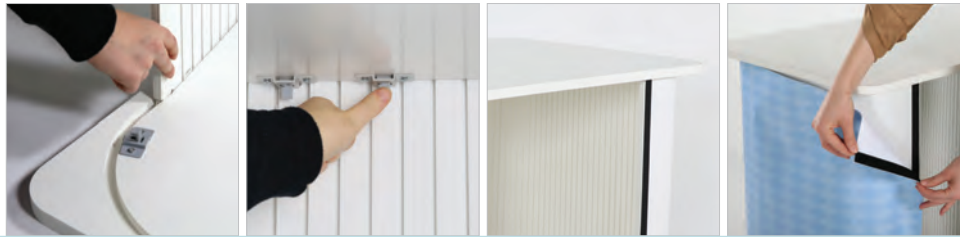

This simple counter is suitable for all kind of promotion events for retail promotions such as exhibitions, supermarkets, demonstrations. Rectangular Promostand is a stock saving product. Ledge Rectangular Promostand that gives more space for item promoted. Header Rectangular Promostand allows for personalizing and helps the brand and promotion to be seen from a distance. Also offered with a choice of felt fabric in grey.

Packed unassembled with an easy-to-understand instruction sheet.

Flat - pack design.

Inner shelf, header, carry bag, brochure holders excluded. See Free Standing System pages for more accessory options.

2 packs. See info chart for pack sizes.



Don't forget to order separately

- Inner shelf
- Grey felt
- Carry bag
- Header
- Ledge

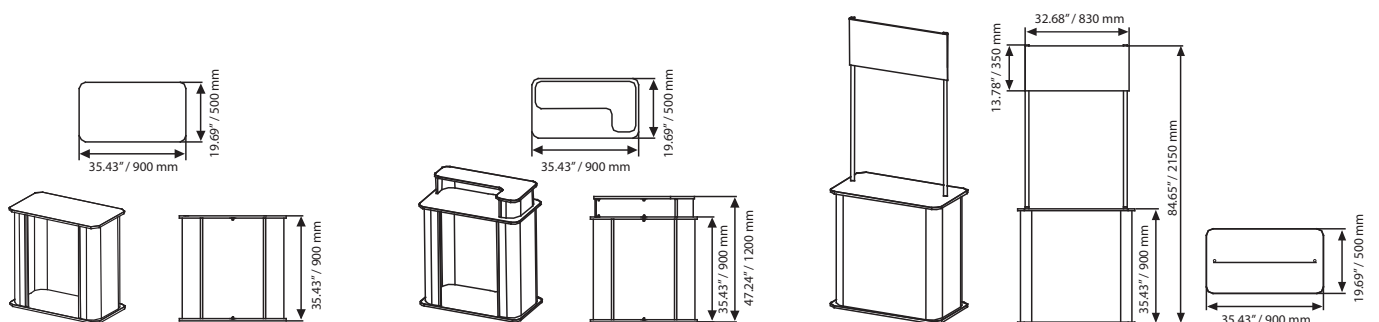
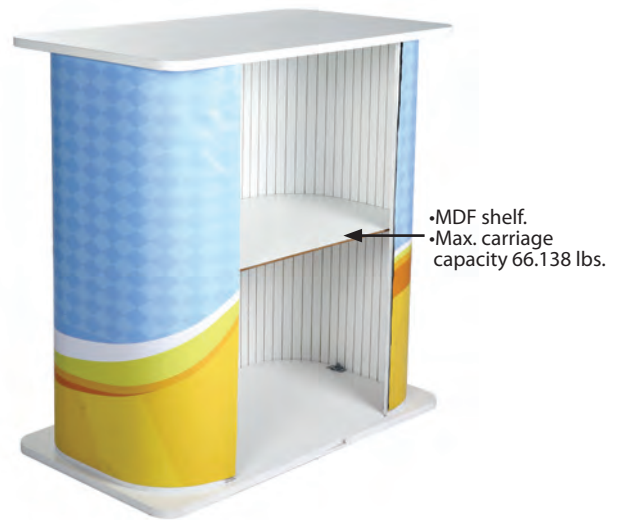



See movie at our website www.mtdisplays.com.tr

Rectangular Ledge Promostand



0.39" / 10 mm
Multiwall PP.

•Hard white top plate.
•Max. carriage
capacity 154.323 lbs.

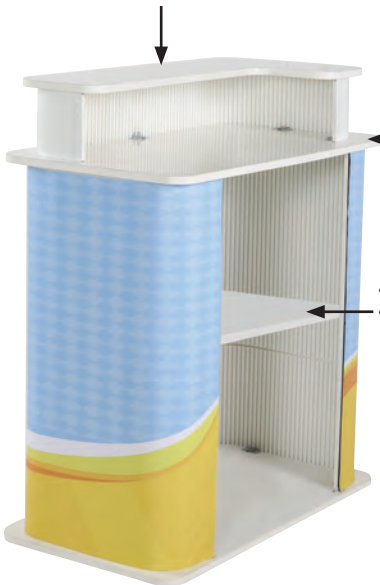

•Hard white top
plate.
•Max. carriage
capacity
154.323 lbs.

•MDF shelf.
•Max. carriage
capacity 66.138 lbs.



See movie at our website www.mtdisplays.com.tr

Rectangular Promostand with Header

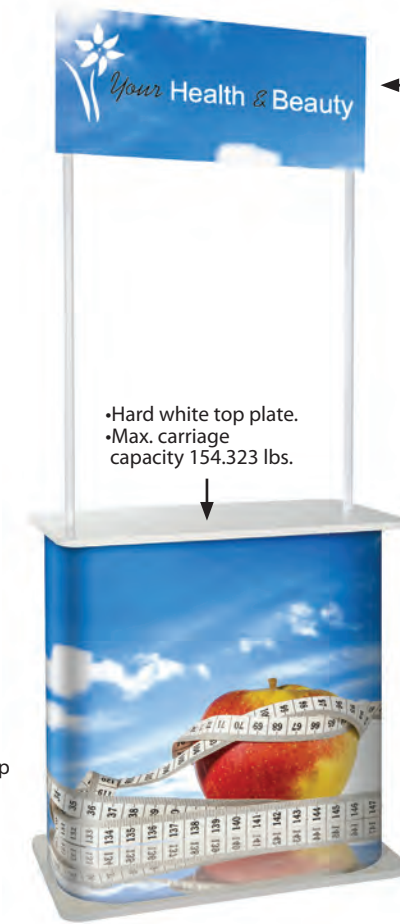

0.12" / 3 mm
PVC Foam.

•Hard white top plate.
•Max. carriage
capacity 154.323 lbs.

Don't forget to order
separately
• Inner shelf
• Grey felt
• Carry bag
• Header
• Ledge

Strong &
elegant powder
coated steel
pipes.



0.39" / 10 mm
Multiwall PP.



UYPOTS1050
Carry bag



UYPOTS0030
Velcro Roll with double
sided tape 59 ft.



UYPOTSD03G
Grey felt only for Rectangular
Promostand incl.
Velcro set for 35.43"

| MATERIAL : Plastic | | | | WEIGHT | PACKING SIZE |
|--------------------|--|-----------------|-----------------|--------------|--|
| ARTICLE | DESCRIPTION | PANEL SIZE | PRINTING SIZE | WITH PACKING | *W X H X D |
| UTSD000909 | w/out bag,w/out felt,w/out shelf | 72.80" X 35.12" | 71.46" X 34.06" | 25.353 lbs | 21.06" X 37.01" X 2.76" / 7.87" X 37.01" X 7.87" |
| UTSD020909 | with header,w/out bag,w/out felt,w/out shelf | 72.80" X 35.12" | 71.46" X 34.06" | 31.526 lbs | 21.06" X 37.01" X 3.74" / 7.87" X 48.82" X 7.87" |
| UTSD010912 | Ledge w/out bag,w/out felt,w/out shelf | 72.80" X 35.12" | 71.46" X 34.06" | 31.967 lbs | 22.44" X 40.94" X 3.74" / 7.87" X 37.01" X 7.87" |
| UYPOTSD010 | Inner shelf only,white | 33.46" X 17.72" | | 3.858 lbs | 33.66" X 17.68" X 0.28" |
| UYPOTSD020 | Inner shelf only for header ,white | 33.46" X 17.72" | | 3.858 lbs | 33.66" X 17.68" X 0.28" |
| UYPOTSD03G | Grey felt only incl.Velcro. | 73.62" X 34.06" | 73.62" X 34.06" | 0.793 lbs | 9.84" X 9.84" X 3.94" |

*W:Width H: Height D: Depth



Circle Promostand



See movie at our website www.mtdisplays.com.tr



This round counter is suitable for all kind of promotion events for retail promotions such as exhibitions, supermarkets, demonstrations. Round shape takes attention and gives more space for visitors to examine items presented. Circle Promostand is a stock saving product. Keeping components available in stock as flat-pack, it enables to offer numerous of variations. Ledge Circle Promostand that gives more space for item promoted. Header Circle Promostand allows for personalizing and helps the brand and promotion to be seen from a distance. Also offered with a choice of felt fabric in grey.

Packed unassembled with an easy-to-understand instruction sheet.

Flat - pack design.

Inner shelf, header, carry bag, brochure holders excluded. See Free Standing System pages for more accessory options.

2 packs. See info chart for pack sizes.



Don't forget to order separately

- Inner shelf
- Grey felt
- Carry bag
- Header
- Ledge

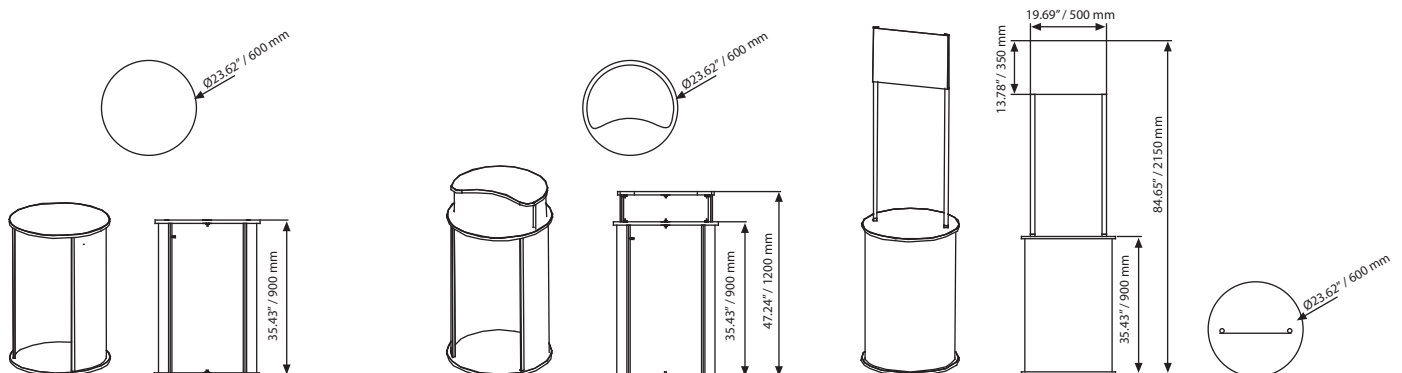



See movie at our website www.mtdisplays.com.tr

Circle Ledge Promostand



- Hard white top plate.
- Max. carriage capacity 154.323 lbs.



See movie at our website www.mtdisplays.com.tr



- 0.39" / 10 mm Multiwall PP.

Circle Promostand with Header

Don't forget to order separately

- Inner shelf
- Grey felt
- Carry bag
- Header
- Ledge



- 0.12" / 3 mm PVC Foam.

- Strong & elegant powder coated steel pipes

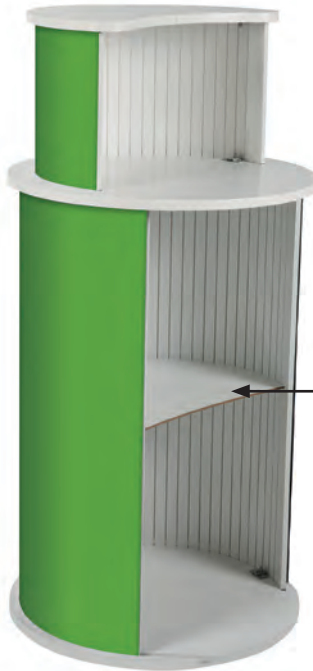

- Hard white top plate.
- Max. carriage capacity 154.323 lbs.

- MDF shelf.
- Max. carriage capacity 66.138 lbs.



- Hard white top plate.
- Max. carriage capacity 154.323 lbs.

- 0.39" / 10 mm Multiwall PP.

- MDF shelf.
- Max. carriage capacity 66.138 lbs.



UYPOTS3050 Carry bag

| MATERIAL : Plastic | | | | WEIGHT | PACKING SIZE |
|--------------------|--|-----------------|-----------------|--------------|--|
| ARTICLE | DESCRIPTION | PANEL SIZE | PRINTING SIZE | WITH PACKING | *W X H X D |
| UTSR000609 | w/out bag,w/out felt,w/out shelf | 48.74" X 35.12" | 47.40" X 34.06" | 16.534 lbs | 24.80" X 24.80" X 2.76" / 7.87" X 37.01" X 7.87" |
| UTSR020609 | with header,w/out bag,w/out felt,w/out shelf | 48.74" X 35.12" | 47.40" X 34.06" | 22.487 lbs | 24.80" X 24.80" X 3.74" / 7.87" X 40.94" X 7.87" |
| UTSR010612 | Ledge w/out bag,w/out felt,w/out shelf | 48.74" X 35.12" | 47.40" X 34.06" | 21.384 lbs | 24.80" X 24.80" X 3.74" / 7.87" X 48.82" X 7.87" |
| UYPOTSR010 | Inner shelf only,white | 21.65" X 16.34" | | 1.984 lbs | 21.85" X 16.54" X 0.28" |
| UYPOTSR020 | Inner shelf only for header ,white | 21.65" X 16.34" | | 1.984 lbs | 21.85" X 16.54" X 0.28" |
| UYPOTSR03G | Grey felt only incl.Velcro. | 49.33" X 34.06" | 49.33" X 34.06" | 0.683 lbs | 9.84" X 9.84" X 3.94" |

*W:Width H: Height D: Depth



UYPOTS0030
Velcro Roll with double sided tape 59 ft.



UYPOTSR03G
Grey felt only for Circle Promostand incl. Velcro set for 35.43"



Bean Promostand



See movie at our website www.mtdisplays.com.tr



This contemporary counter is suitable for all kind of promotion events for retail promotions such as exhibitions, supermarkets, demonstrations. Bean Promostand is a stock saving product. Keeping components available in stock as flat-pack, it enables to offer numerous of variations. Ladder Bean Promostand that gives more space for item promoted. Header Bean Promostand allows for personalizing. Also offered with a choice of felt fabric in grey.

Packed unassembled with an easy-to-understand instruction sheet.

Flat - pack design.

Inner shelf, header, carry bag, brochure holders excluded. See Free Standing System pages for more accessory options.

2 packs. See info chart for pack sizes.

Don't forget to order separately

- Inner shelf
- Grey felt
- Carry bag
- Header
- Ledge

•Hard white top plate.
•Max. carriage capacity 154.323 lbs.



← 0.39" / 10 mm
Multiwall PP.



•MDF shelf.
•Max. carriage capacity 66.138 lbs.

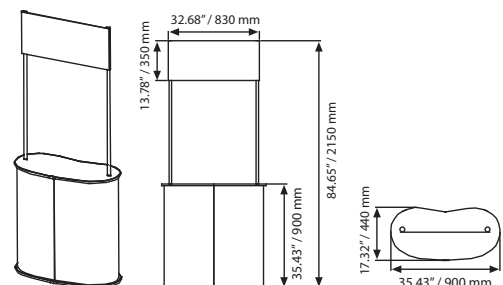
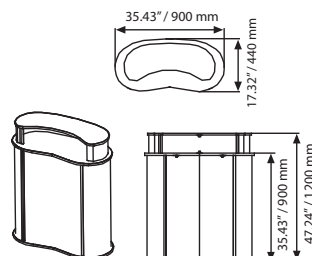
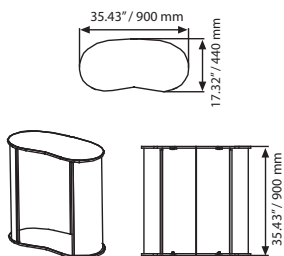



See movie at our website www.mtdisplays.com.tr

Bean Ledge Promostand



0.39" / 10 mm
Multiwall PP.

•Hard white top plate.
•Max. carriage
capacity 154.323 lbs.



•Hard white top plate.
•Max. carriage
capacity 154.323 lbs.

•MDF shelf.
•Max. carriage
capacity 66.138 lbs.



UYPOTS1050
Carry bag

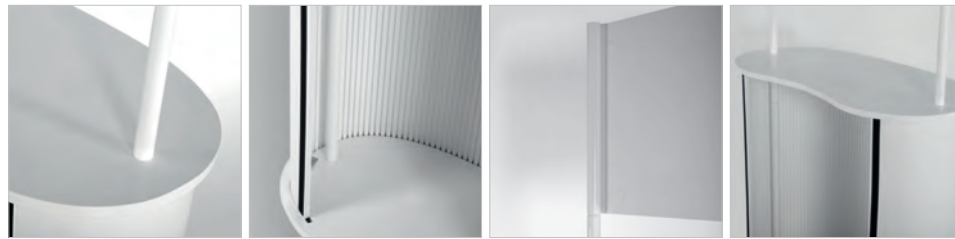

See movie at our website www.mtdisplays.com.tr

Bean Promostand with Header



•Hard white top plate.
•Max. carriage
capacity 154.323 lbs.

Strong & elegant
powder coated
steel pipes

Don't forget to order
separately
• Inner shelf
• Grey felt
• Carry bag
• Header
• Ledge



0.12" / 3 mm
PVC Foam.

•MDF shelf.
•Max. carriage
capacity 66.138 lbs.

0.39" / 10 mm
Multiwall PP.



UYPOTS0030
Velcro Roll with double
sided tape 59 ft.

UYPOTSB03G
Grey felt only for Bean
Promostand incl. Velcro
set for 35.43".

| MATERIAL : Plastic | | | | WEIGHT | PACKING SIZE |
|--------------------|--|-----------------|-----------------|--------------|--|
| ARTICLE | DESCRIPTION | PANEL SIZE | PRINTING SIZE | WITH PACKING | *W X H X D |
| UTSB000909 | w/out bag,w/out felt,w/out shelf | 61.30" X 35.12" | 59.96" X 34.06" | 20.943 lbs | 18.50" X 18.50" X 2.76" / 7.87" X 37.01" X 7.87" |
| UTSB020909 | with header,w/out bag,w/out felt,w/out shelf | 61.30" X 35.12" | 59.96" X 34.06" | 26.896 lbs | 18.50" X 37.01" X 3.74" / 7.87" X 48.82" X 7.87" |
| UTSB010912 | Ledge w/out bag,w/out felt,w/out shelf | 61.30" X 35.12" | 59.96" X 34.06" | 27.116 lbs | 510 X 1040 X 3.74" / 7.87" X 37.01" X 7.87" |
| UYPOTSB010 | Inner shelf only,white | 33.66" X 14.57" | | 2.645 lbs | 33.86" X 15.20" X 0.28" |
| UYPOTSB020 | Inner shelf only for header ,white | 33.66" X 14.57" | | 2.645 lbs | 33.86" X 15.20" X 0.28" |
| UYPOTSB03G | Grey felt only incl.Velcro. | 62.01" X 34.06" | 62.01" X 34.06" | 0.749 lbs | 9.84" X 9.84" X 3.94" |



* W:Width H: Height D: Depth



Tumble Box



The clear acrylic Tumble Box makes voting transparent, by granting the people insight into the box. Also this box helps to collect the demands, suggestions or complaints of workers in companies, restaurants or offices. Serves the collection of different tickets. Fits perfect in a counter with limited space. Accepts printing on surrounding walls. There is a lock system at its top keeping the documents safe inside at the front side of the cube.

-  Each box includes 1 key set of single variation.
-  Please handle with care during transportation.

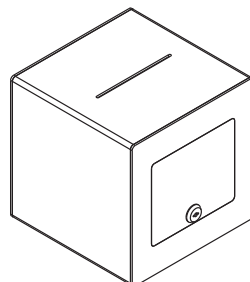
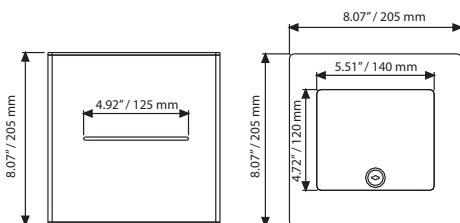
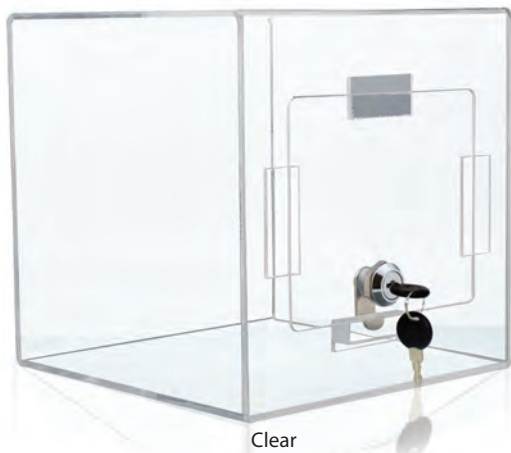

| MATERIAL : Acrylic | | WEIGHT | PACKING SIZE |
|--------------------|-------------|--------------|-----------------------|
| ARTICLE | DESCRIPTION | WITH PACKING | *W X H X D |
| UTBCOS000 | Clear | 2.821 lbs | 9.45" X 9.84" X 9.45" |
| UTBCOW000 | Opaque | 2.821 lbs | 9.45" X 9.84" X 9.45" |

*W:Width H: Height D: Depth



Puzzle Tumble Box



See movie at our website www.mtdisplays.com.tr



Locking Puzzle Box is suitable for different environments. Easy to assemble with help of mounting sheet provided. Key and padlock securely protect the box content. Flat pack saves from space. This suggestion box is perfect for high traffic areas. Available in 2 sizes.

 Please handle with care during transportation. Please peel of the film over the product before use.

 Available with header and without header. Available in Opaque and Transparent finishes.

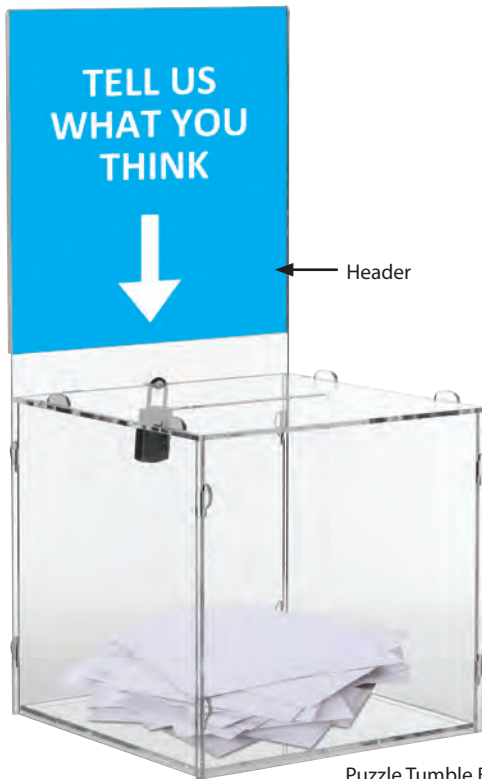

Puzzle Tumble Box with Header

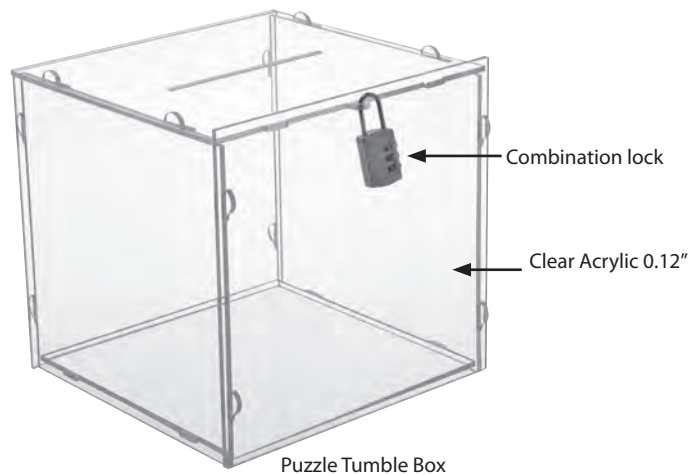

Puzzle Tumble Box



Flat pack

Puzzle Tumble Box

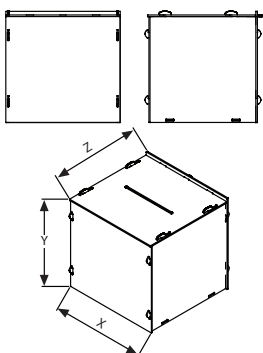

Puzzle Tumble Box with Header

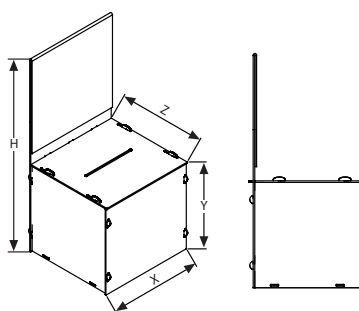

| MATERIAL : Clear acrylic 3 mm | | | | | WEIGHT | PACKING SIZE |
|-------------------------------|------------|--------------------------|--------|-------------------|--------------|-------------------------|
| ARTICLE | SIZE | EXTERNAL (x-y-z) | H | DESCRIPTION | WITH PACKING | *W X H X D |
| UTBP0S0085 | 8.5" X 11" | 8.50" X 8.27" X 8.50" | - | Clear | 3.306 lbs | 9.84" X 20.08" X 0.83" |
| UTBP0S0012 | 12" X 12" | 12.01" X 11.77" X 12.01" | - | Clear | 5.180 lbs | 13.78" X 26.77" X 0.83" |
| UTBP0S1085 | 8.5" X 11" | 8.50" X 8.27" X 8.50" | 17.52" | Clear with header | 4.122 lbs | 9.84" X 20.08" X 0.83" |
| UTBP0S1012 | 12" X 12" | 12.01" X 11.77" X 12.01" | 24.80" | Clear with header | 6.922 lbs | 13.78" X 26.77" X 0.83" |

*W:Width H: Height D: Depth



Free Standing Puzzle Tumble Box



See movie at our website www.mtdisplays.com.tr



Locking Floor Standing Puzzle Box is suitable for different environment where the space is very tight. Easy to assemble with help of mounting sheet provided. Key and padlock securely protect the box content. Flat pack saves from space. This suggestion box is perfect for high traffic areas and suitable for tradeshows and fundraising even as well. Available in 2 sizes. It has a sturdy metal base which provide stability.

Please handle with care during transportation. Please peel of the film over the product before use.

Available with header and without header. Available in Opaque and Transparent finishes.

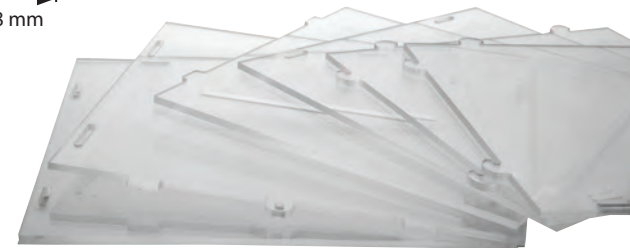
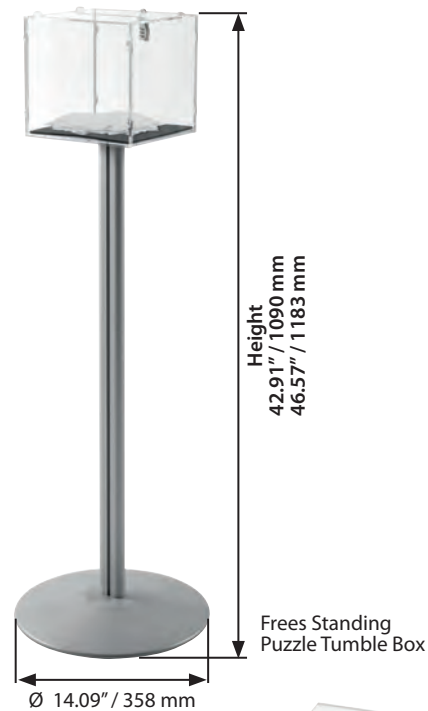
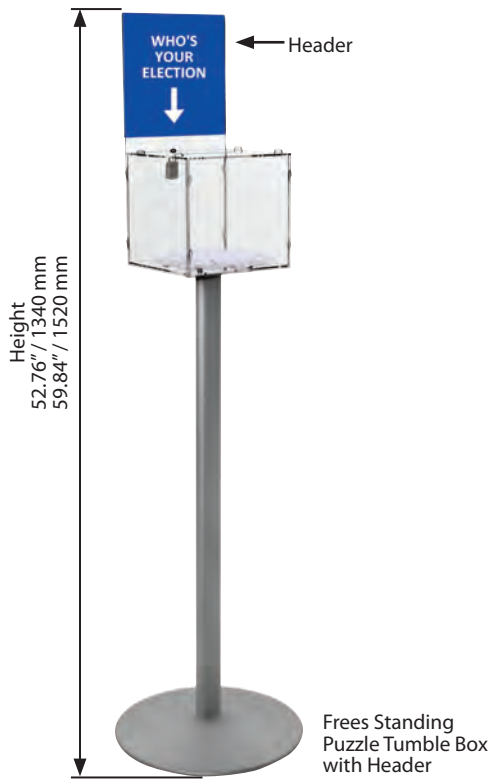

Flat pack

Free Standing Puzzle Tumble Box

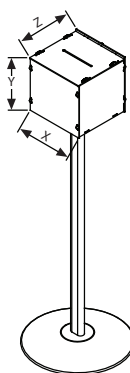

Weight of base is 1.763 lbs.

Free Standing Puzzle Tumble Box with Header

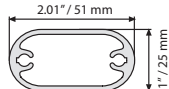
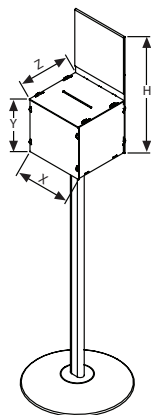

| MATERIAL : Clear acrylic 3 mm | | | | | WEIGHT | PACKING SIZE |
|-------------------------------|------------|--------------------------|--------|-------------------|--------------|-------------------------|
| ARTICLE | SIZE | EXTERNAL (x-y-z) | H | DESCRIPTION | WITH PACKING | *W X H X D |
| UTBP1S0085 | 8.5" X 11" | 8.50" X 8.27" X 8.50" | - | Clear | 13.580 lbs | 16.93" X 36.22" X 2.76" |
| UTBP1S0012 | 12" X 12" | 12.01" X 11.77" X 12.01" | - | Clear | 16.534 lbs | 16.93" X 44.09" X 2.76" |
| UTBP1S1085 | 8.5" X 11" | 8.50" X 8.27" X 8.50" | 17.52" | Clear with header | 14.021 lbs | 16.93" X 36.22" X 2.76" |
| UTBP1S1012 | 12" X 12" | 12.01" X 11.77" X 12.01" | 24.80" | Clear with header | 16.534 lbs | 16.93" X 44.09" X 2.76" |

*W:Width H: Height D: Depth



Rectangular Promostand with Header





Office Products

- Door Signs
- Desktop Sign
- Wall Sign System
- Wall Sign Double Sided
- Sign Systems
 - Toilet Logo Systems Chrome
 - Decorative Toilet Signs
 - Aluminum Panel Braille Signs
 - ABS Plastic Braille Signs
 - Plastic Chromed House Numbers
- Clip Board
- Fast Note
- Magnetic Glass Board
- Business Card Holder
- Coat Racks
 - Spring Coat Rack
 - Pine Coat Rack
 - Sunflower Coat Rack
 - Fountain Coat Rack
 - Ladder Coat Rack
 - Coat Hanger Stand
 - Maze Coat Rack
 - Trio Coat Rack
- Waste Baskets
 - Flat Pedal Trash Can
 - Hotel Trash Can
 - Flat Pedal Trash Can Inner Bucket
 - Stainless Steel Push Can Dust Bin
 - Single Wall Stainless Steel Waste Basket
 - Double Wall Stainless Steel Waste Basket
 - Angled Top Stainless Steel Stand-up Ashtray
 - Stainless Steel Stand-up Ashtray
- 2 Step Plastic Stepstool **NEW**



Door Signs

0.59" - 1.02"



See movie at our website www.mtdisplays.com.tr



Suitable for use in open-air spaces or public areas such as schools, offices, hospitals, etc.. It is an elegant and practical product. You merely need to open the front profile in order to change your documents. An anti-reflex PET cover protects your documents from tearing and suffering damage. It can be used both in portrait and landscape positions.

Each door sign includes adhesive tape & mounting instruction sheet.

0.59" in top snap 0.31" poster & in bottom snap 0.31" poster is placed within the clamping system. 1.02" in top snap 0.43" poster & in bottom snap 0.43" poster is placed within the clamping system. Please clean the surface before applying the double-sided tape for better application.



0.59" / 15 mm



1.02" / 26 mm

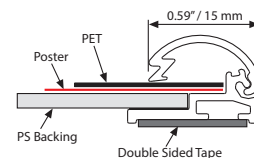
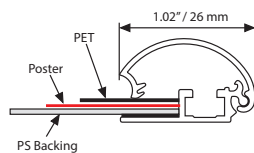
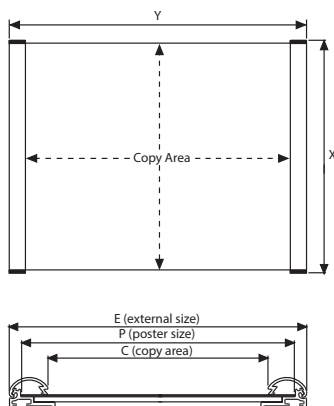

| 0.59" / 15 mm: Silver anodised aluminium Poster Snap | | | | WEIGHT | PACKING SIZE |
|--|----------------|------------|---------------|--------------|---------------------------------|
| ARTICLE | EXTERNAL (x-y) | POSTER | COPY | WITH PACKING | *W X H X D |
| UDS150N046 | 4.20" X 6.39" | 4" X 6" | 4" X 5.17" | 1.333 lbs | 4.72" X 7.87" X 3.94" (5 Pcs) |
| UDS150N057 | 5.20" X 7.39" | 5" X 7" | 5" X 6.17" | 1.984 lbs | 7.09" X 9.45" X 5.51" (5 Pcs) |
| UDS150N081 | 8.70" X 11.39" | 8.5" X 11" | 8.5" X 10.17" | 5.577 lbs | 9.65" X 13.78" X 3.15" (10 Pcs) |
| 1.02" / 26 mm: Silver anodised aluminium Poster Snap | | | | WEIGHT | PACKING SIZE |
| ARTICLE | EXTERNAL (x-y) | POSTER | COPY | WITH PACKING | *W X H X D |
| UDS0008000 | 4.24" X 7.14" | 4" X 6" | 4" X 5.13" | 1.102 lbs | 4.72" X 7.87" X 3.94" (10 pcs) |
| UDS0007000 | 5.24" X 8.14" | 5" X 7" | 5" X 6.13" | 1.984 lbs | 5.31" X 7.87" X 3.94" (5 pcs) |
| UDS0006000 | 8.74" X 12.14" | 8.5" X 11" | 8.5" X 10.13" | 2.976 lbs | 10.04" X 13.39" X 3.15" (5 pcs) |

* W:Width H:Height D:Depth





Desktop Signs



Offering a complete range, aluminium wall sign profiles are design to enable usage on a counter to match Wall Signs. Desktop Sign is fixed to a convenient reading angle to be seen by the customers easily. It is suitable for receptions, restaurants, cafés and many more. It is a practical product to change the message very often.

 Use the suction cup enclosed to easily remove the insert.

 Compatible signage methods; printed papers from common printers, cut vinyl, digitally printed vinyl, screen-printed materials.

 Suitable for paper, plastic or any flexible material up to 0.04" thick.

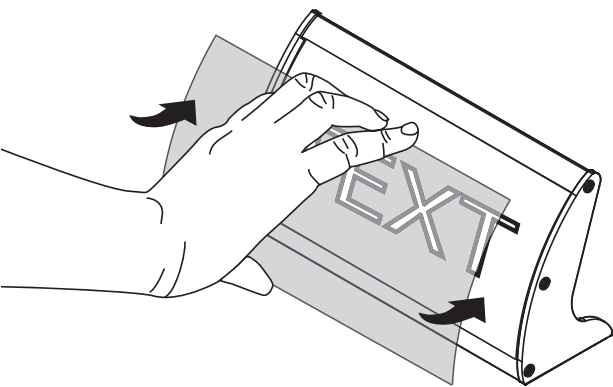

Suction Cup / UYAA006010

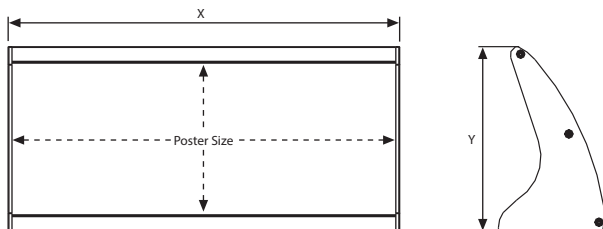

| DESKTOP SIGN: Silver anodised aluminium | | | WEIGHT | PACKING SIZE |
|---|----------------|----------------|--------------|------------------------|
| ARTICLE | EXTERNAL (x-y) | POSTER SIZE | WITH PACKING | *W X H X D |
| UMDS740N15 | 6.10" X 3.23" | 2.91" X 5.91" | 0.440 lbs | 4.33" X 7.09" X 2.95" |
| UMDS740N20 | 8.07" X 3.23" | 2.91" X 7.87" | 0.551 lbs | 4.33" X 9.06" X 2.95" |
| UMDS740N25 | 10.04" X 3.23" | 2.91" X 9.84" | 0.771 lbs | 4.33" X 11.02" X 2.95" |
| UMDS105N15 | 6.10" X 4.33" | 4.13" X 5.91" | 0.551 lbs | 5.51" X 6.69" X 3.35" |
| UMDS105N20 | 8.07" X 4.33" | 4.13" X 7.87" | 0.771 lbs | 5.51" X 9.06" X 3.35" |
| UMDS105N25 | 10.04" X 4.33" | 4.13" X 9.84" | 0.881 lbs | 5.51" X 11.02" X 3.35" |
| UMDS105N30 | 12.01" X 4.33" | 4.13" X 11.81" | 0.992 lbs | 5.51" X 12.99" X 3.35" |
| UMDS148N20 | 8.07" X 5.83" | 5.83" X 7.87" | 0.881 lbs | 7.09" X 9.06" X 3.74" |
| UMDS148N25 | 8.07" X 5.83" | 5.83" X 9.84" | 0.992 lbs | 7.09" X 11.02" X 3.74" |
| UMDS148N30 | 12.01" X 5.83" | 5.83" X 11.81" | 1.102 lbs | 7.09" X 12.60" X 3.74" |

*W:Width H:Height D:Depth



Wall Sign System



See movie at our website www.mtdisplays.com.tr

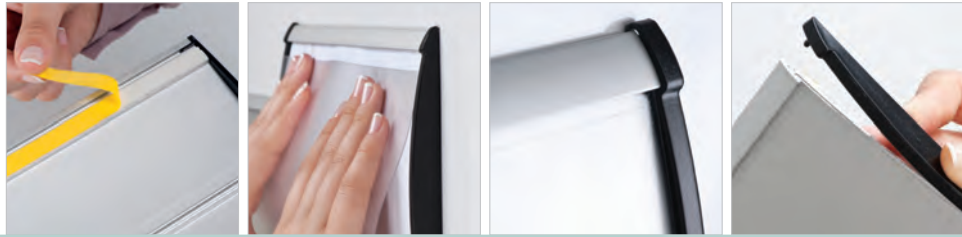

Fast and simple!

The Wall Sign system is a perfect solution for wall posters and signs. It allows clear visibility for the poster and has an aesthetic curved shape. The stylish curved Wall Sign system in various sizes suits the room sign and way finding needs within the building. Designed for paper inserts and is offered in variety of profile types to match different projects. The front cover is anti-reflex which is flexed into place after inserting the paper. Poster inserts can be created from common inkjet or laser printers. Printed-paper inserts may be in portrait or landscape outline and various sizes fitting in 4 profile types.

Each sign includes double sided tape, one suction cup and mounting instruction sheet.

Use the suction cup to easily remove the inserts from the signs by simply attaching it to the inserts and pulling.

Compatible signage methods; printed papers from common printers, cut vinyl, digitally printed vinyl, screen-printing. Please clean the surface before applying the double-sided tape for better application.



5.83" x 11.81" / 148 x 300 mm



4.13" x 9.84" / 105 x 250 mm



2.91" x 5.91" / 74 x 150 mm



2.05" x 5.91" / 52 x 150 mm



Flat cap



Arc cap



Double sided tape



Suction cup



Model 2.05" / 52 mm

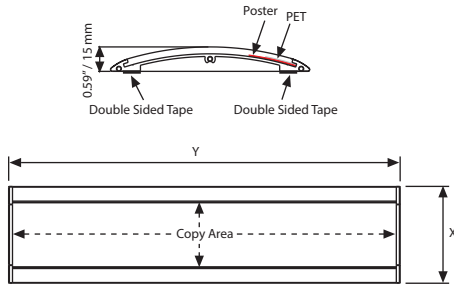

Model 2.91" / 74 mm

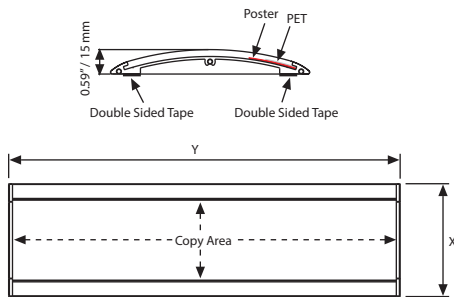

Model 4.13" / 105 mm

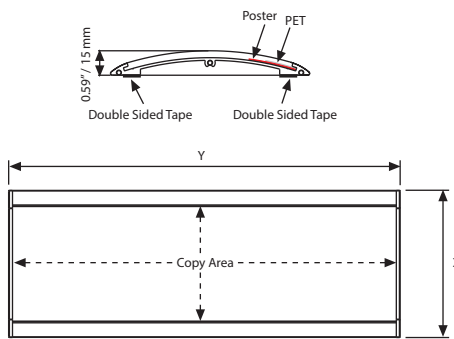

Model 5.83" / 148 mm

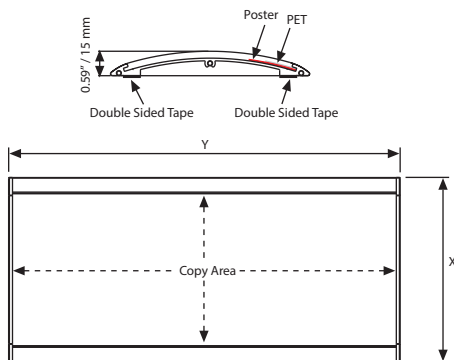

| WALL SIGN SYSTEM 2.05" / 52 mm : Silver anodised aluminium | | | | | WEIGHT | PACKING SIZE (10 Pcs) |
|--|-------------|----------------|----------------|----------------|--------------|------------------------|
| ARTICLE | MODEL | EXTERNAL (x-y) | POSTER | COPY | WITH PACKING | *W X H X D |
| UDS520NA10 | Flat Endcap | 2.68" X 4.17" | 2.05" X 3.94" | 1.81" X 3.94" | 1.477 lbs | 6.30" X 5.51" X 3.94" |
| UDS520NA15 | Flat Endcap | 2.68" X 6.14" | 2.05" X 5.91" | 1.81" X 5.91" | 2.171 lbs | 6.30" X 7.48" X 3.94" |
| UDS520NA20 | Flat Endcap | 2.68" X 8.11" | 2.05" X 7.87" | 1.81" X 7.87" | 2.866 lbs | 6.30" X 9.45" X 3.94" |
| UDS520NA25 | Flat Endcap | 2.68" X 10.08" | 2.05" X 9.84" | 1.81" X 9.84" | 3.560 lbs | 6.30" X 11.42" X 3.94" |
| UDS520NA30 | Flat Endcap | 2.68" X 12.05" | 2.05" X 11.81" | 1.81" X 11.81" | 4.254 lbs | 6.30" X 13.39" X 3.94" |
| UDS520NA35 | Flat Endcap | 2.68" X 14.02" | 2.05" X 13.78" | 1.81" X 13.78" | 4.949 lbs | 6.30" X 15.35" X 3.94" |
| UDS520NA40 | Flat Endcap | 2.68" X 15.98" | 2.05" X 15.75" | 1.81" X 15.75" | 5.643 lbs | 6.30" X 17.32" X 3.94" |
| UDS520NA45 | Flat Endcap | 2.68" X 17.95" | 2.05" X 17.72" | 1.81" X 17.72" | 6.338 lbs | 6.30" X 19.29" X 3.94" |
| UDS520NB10 | Arc Endcap | 2.68" X 4.17" | 2.05" X 3.94" | 1.81" X 3.70" | 1.477 lbs | 6.30" X 5.51" X 3.94" |
| UDS520NB15 | Arc Endcap | 2.68" X 6.14" | 2.05" X 5.91" | 1.81" X 5.67" | 2.171 lbs | 6.30" X 7.48" X 3.94" |
| UDS520NB20 | Arc Endcap | 2.68" X 8.11" | 2.05" X 7.87" | 1.81" X 7.64" | 2.866 lbs | 6.30" X 9.45" X 3.94" |
| UDS520NB25 | Arc Endcap | 2.68" X 10.08" | 2.05" X 9.84" | 1.81" X 9.61" | 3.560 lbs | 6.30" X 11.42" X 3.94" |
| UDS520NB30 | Arc Endcap | 2.68" X 12.05" | 2.05" X 11.81" | 1.81" X 11.57" | 4.254 lbs | 6.30" X 13.39" X 3.94" |
| UDS520NB35 | Arc Endcap | 2.68" X 14.02" | 2.05" X 13.78" | 1.81" X 13.54" | 4.949 lbs | 6.30" X 15.35" X 3.94" |
| UDS520NB40 | Arc Endcap | 2.68" X 15.98" | 2.05" X 15.75" | 1.81" X 15.51" | 5.643 lbs | 6.30" X 17.32" X 3.94" |
| UDS520NB45 | Arc Endcap | 2.68" X 17.95" | 2.05" X 17.72" | 1.81" X 17.48" | 6.338 lbs | 6.30" X 19.29" X 3.94" |

| WALL SIGN SYSTEM 2.91" / 74 mm : Silver anodised aluminium | | | | | WEIGHT | PACKING SIZE (10 Pcs) |
|--|-------------|----------------|----------------|----------------|--------------|------------------------|
| ARTICLE | MODEL | EXTERNAL (x-y) | POSTER | COPY | WITH PACKING | *W X H X D |
| UDS740NA15 | Flat Endcap | 3.54" X 6.14" | 2.91" X 5.91" | 2.68" X 5.91" | 2.380 lbs | 8.27" X 7.48" X 3.94" |
| UDS740NA20 | Flat Endcap | 3.54" X 8.11" | 2.91" X 7.87" | 2.68" X 7.87" | 3.152 lbs | 8.27" X 9.45" X 3.94" |
| UDS740NA25 | Flat Endcap | 3.54" X 10.08" | 2.91" X 9.84" | 2.68" X 9.84" | 3.924 lbs | 8.27" X 11.42" X 3.94" |
| UDS740NA30 | Flat Endcap | 3.54" X 12.05" | 2.91" X 11.81" | 2.68" X 11.81" | 4.629 lbs | 8.27" X 13.39" X 3.94" |
| UDS740NA35 | Flat Endcap | 3.54" X 14.02" | 2.91" X 13.78" | 2.68" X 13.78" | 5.423 lbs | 8.27" X 15.35" X 3.94" |
| UDS740NA40 | Flat Endcap | 3.54" X 15.98" | 2.91" X 15.75" | 2.68" X 15.75" | 5.533 lbs | 8.27" X 17.32" X 3.94" |
| UDS740NA45 | Flat Endcap | 3.54" X 17.95" | 2.91" X 17.72" | 2.68" X 17.72" | 6.305 lbs | 8.27" X 19.29" X 3.94" |
| UDS740NA50 | Flat Endcap | 3.54" X 19.92" | 2.91" X 19.69" | 2.68" X 19.69" | 7.098 lbs | 8.27" X 21.26" X 3.94" |
| UDS740NB15 | Arc Endcap | 3.54" X 6.14" | 2.91" X 5.91" | 2.68" X 5.67" | 2.380 lbs | 8.27" X 7.48" X 3.94" |
| UDS740NB20 | Arc Endcap | 3.54" X 8.11" | 2.91" X 7.87" | 2.68" X 7.64" | 3.152 lbs | 8.27" X 9.45" X 3.94" |
| UDS740NB25 | Arc Endcap | 3.54" X 10.08" | 2.91" X 9.84" | 2.68" X 9.61" | 3.924 lbs | 8.27" X 11.42" X 3.94" |
| UDS740NB30 | Arc Endcap | 3.54" X 12.05" | 2.91" X 11.81" | 2.68" X 11.57" | 4.629 lbs | 8.27" X 13.39" X 3.94" |
| UDS740NB35 | Arc Endcap | 3.54" X 14.02" | 2.91" X 13.78" | 2.68" X 13.54" | 5.423 lbs | 8.27" X 15.35" X 3.94" |
| UDS740NB40 | Arc Endcap | 3.54" X 15.98" | 2.91" X 15.75" | 2.68" X 15.51" | 5.533 lbs | 8.27" X 17.32" X 3.94" |
| UDS740NB45 | Arc Endcap | 3.54" X 17.95" | 2.91" X 17.72" | 2.68" X 17.48" | 6.305 lbs | 8.27" X 19.29" X 3.94" |
| UDS740NB50 | Arc Endcap | 3.54" X 19.92" | 2.91" X 19.69" | 2.68" X 19.45" | 7.098 lbs | 8.27" X 21.26" X 3.94" |

| WALL SIGN SYSTEM 4.13" / 105 mm : Silver anodised aluminium | | | | | WEIGHT | PACKING SIZE (10 Pcs) |
|---|-------------|----------------|----------------|----------------|--------------|-------------------------|
| ARTICLE | MODEL | EXTERNAL (x-y) | POSTER | COPY | WITH PACKING | *W X H X D |
| UDS105NA25 | Flat Endcap | 4.72" X 10.08" | 4.13" X 9.84" | 3.90" X 9.84" | 5.180 lbs | 10.63" X 11.42" X 3.94" |
| UDS105NA30 | Flat Endcap | 4.72" X 12.05" | 4.13" X 11.81" | 3.90" X 11.81" | 6.239 lbs | 10.63" X 13.39" X 3.94" |
| UDS105NA35 | Flat Endcap | 4.72" X 14.02" | 4.13" X 13.78" | 3.90" X 13.78" | 7.187 lbs | 10.63" X 15.35" X 3.94" |
| UDS105NA40 | Flat Endcap | 4.72" X 15.98" | 4.13" X 15.75" | 3.90" X 15.75" | 8.245 lbs | 10.63" X 17.32" X 3.94" |
| UDS105NA50 | Flat Endcap | 4.72" X 19.92" | 4.13" X 19.69" | 3.90" X 19.69" | 10.361 lbs | 10.63" X 21.26" X 3.94" |
| UDS105NA60 | Flat Endcap | 4.72" X 23.86" | 4.13" X 23.62" | 3.90" X 23.62" | 12.919 lbs | 10.63" X 25.20" X 3.94" |
| UDS105NB25 | Arc Endcap | 4.72" X 10.08" | 4.13" X 9.84" | 3.90" X 9.61" | 5.180 lbs | 10.63" X 11.42" X 3.94" |
| UDS105NB30 | Arc Endcap | 4.72" X 12.05" | 4.13" X 11.81" | 3.90" X 11.57" | 6.239 lbs | 10.63" X 13.39" X 3.94" |
| UDS105NB35 | Arc Endcap | 4.72" X 14.02" | 4.13" X 13.78" | 3.90" X 13.56" | 7.187 lbs | 10.63" X 15.35" X 3.94" |
| UDS105NB40 | Arc Endcap | 4.72" X 15.98" | 4.13" X 15.75" | 3.90" X 15.51" | 8.245 lbs | 10.63" X 17.32" X 3.94" |
| UDS105NB50 | Arc Endcap | 4.72" X 19.92" | 4.13" X 19.69" | 3.90" X 19.45" | 10.361 lbs | 10.63" X 21.26" X 3.94" |
| UDS105NB60 | Arc Endcap | 4.72" X 23.86" | 4.13" X 23.62" | 3.90" X 23.39" | 12.919 lbs | 10.63" X 25.20" X 3.94" |

| WALL SIGN SYSTEM 5.83" / 148 mm : Silver anodised aluminium | | | | | WEIGHT | PACKING SIZE (10 Pcs) |
|---|-------------|----------------|----------------|----------------|--------------|-------------------------|
| ARTICLE | MODEL | EXTERNAL (x-y) | POSTER | COPY | WITH PACKING | *W X H X D |
| UDS148NA30 | Flat Endcap | 6.38" X 12.05" | 5.83" X 11.81" | 5.59" X 11.81" | 7.407 lbs | 14.17" X 13.39" X 3.94" |
| UDS148NA35 | Flat Endcap | 6.38" X 14.02" | 5.83" X 13.78" | 5.59" X 13.78" | 8.730 lbs | 14.17" X 15.35" X 3.94" |
| UDS148NA40 | Flat Endcap | 6.38" X 15.98" | 5.83" X 15.75" | 5.59" X 15.75" | 10.008 lbs | 14.17" X 17.32" X 3.94" |
| UDS148NA50 | Flat Endcap | 6.38" X 19.92" | 5.83" X 19.69" | 5.59" X 19.69" | 12.478 lbs | 14.17" X 21.26" X 3.94" |
| UDS148NA60 | Flat Endcap | 6.38" X 23.86" | 5.83" X 23.62" | 5.59" X 23.62" | 15.123 lbs | 14.17" X 25.20" X 3.94" |
| UDS148NA65 | Flat Endcap | 6.38" X 25.83" | 5.83" X 25.59" | 5.59" X 25.59" | 16.336 lbs | 14.17" X 27.17" X 3.94" |
| UDS148NB30 | Arc Endcap | 6.38" X 12.05" | 5.83" X 11.81" | 5.59" X 11.57" | 7.407 lbs | 14.17" X 13.39" X 3.94" |
| UDS148NB35 | Arc Endcap | 6.38" X 14.02" | 5.83" X 13.78" | 5.59" X 13.54" | 8.730 lbs | 14.17" X 15.35" X 3.94" |
| UDS148NB40 | Arc Endcap | 6.38" X 15.98" | 5.83" X 15.75" | 5.59" X 15.51" | 10.008 lbs | 14.17" X 17.32" X 3.94" |
| UDS148NB50 | Arc Endcap | 6.38" X 19.92" | 5.83" X 19.69" | 5.59" X 19.45" | 12.478 lbs | 14.17" X 21.26" X 3.94" |
| UDS148NB60 | Arc Endcap | 6.38" X 23.86" | 5.83" X 23.62" | 5.59" X 23.39" | 15.123 lbs | 14.17" X 25.20" X 3.94" |
| UDS148NB65 | Arc Endcap | 6.38" X 25.83" | 5.83" X 25.59" | 5.59" X 25.35" | 16.336 lbs | 14.17" X 27.17" X 3.94" |





*W:Width H: Height D: Depth

Wall Sign Double Sided



Fast and Simple! Aluminium wall sign profiles are designed to create horizontally curved double sided suspended signs. Using your stock of single sided profiles, product offerings can be increased to double sided suspension style. Double Sided Wall Sign is suitable as directional signs, way finding. Suspension cables enclosed enables flexible positioning of the sign. Black endcaps complete the look.

-  Use the suction cup enclosed to easily remove the insert. Peel the tape on the backing and stick for easy application.
-  Compatible signage methods; printed papers from common printers, cut vinyl, digitally printed vinyl, screen-printed materials.
-  Ceiling suspension is included in the pack (31.50" wire cable & 2 x ceiling hanger). Individually packed.

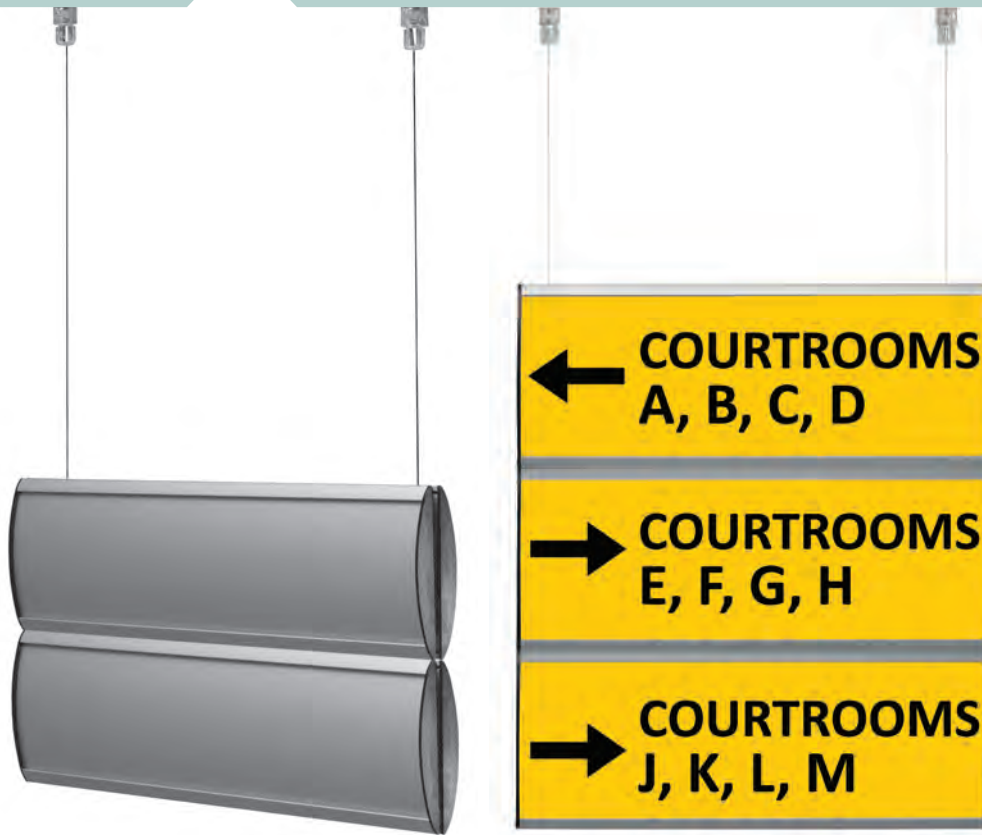

- ✓ Anti-reflex PET covers ensure clarity of message.
- ✓ Easy to access poster with suction cup provided in the pack.
- ✓ Easy to update messages. Suitable for paper, plastic or any flexible material up to 0.04" thick.
- ✓ Available in standard sizes as well as bespoke sizes (subjected to moq).
- ✓ For more than 5 layers please contact to your sales executive.



Suction Cup / UYAA006010



Fixing components (UYPDS00002)
Suspension set (UYPDS00001)

Maximum recommended length: 19.69"

| WALL SIGN DOUBLE SIDED | | |
|------------------------|--|-----------|
| ARTICLE | DESCRIPTION | WEIGHT |
| UYPDS00001 | Double Sided Suspension Set / 2x157.48" fishnet & 2xCeiling Hanger | 0.992 lbs |
| UYPDS00002 | Double Sided Fixing Set (4 Pcs) | 0.110 lbs |

| WALL SIGN DOUBLE SIDED: Silver anodised aluminium | | | | | |
|---|--------------|---------|---------|---------|---------|
| | SINGLE LAYER | 2-LAYER | 3-LAYER | 4-LAYER | 5-LAYER |
| 2.91" | ✓ | ✓ | ✓ | ✓ | ✓ |
| 4.13" | ✓ | ✓ | ✓ | ✓ | ✓ |
| 5.83" | ✓ | ✓ | ✓ | | |



Toilet Logo Systems Chrome



Chrome coated 3D toilet signs are available for men and women in 3.62" and clean neat finish add value to the signs. Easy to apply on the door or wall with self-adhesive tape provided on the back of each sign.

 Peel the tape and stick backing for easy application. Please clean the surface before applying the double-sided tape for better application.

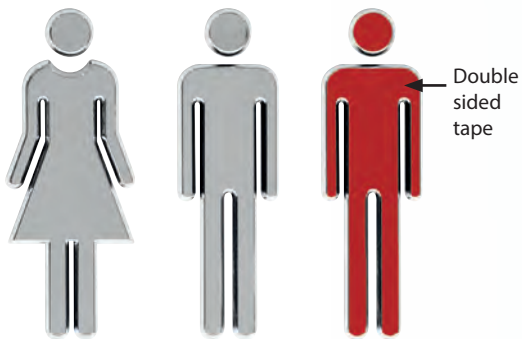

peel & stick

TDFJ92W002 Chromed Toilet Signs, Women
TDFJ92X002 Chromed Toilet Signs, Men
Back Side



TDFJ100C01 Chromed Toilet Signs, Handicap, Grey Panel
TDFJ100W01 Chromed Toilet Signs, Women, Grey Panel
TDFJ100X01 Chromed Toilet Signs, Men, Grey Panel
Back Side

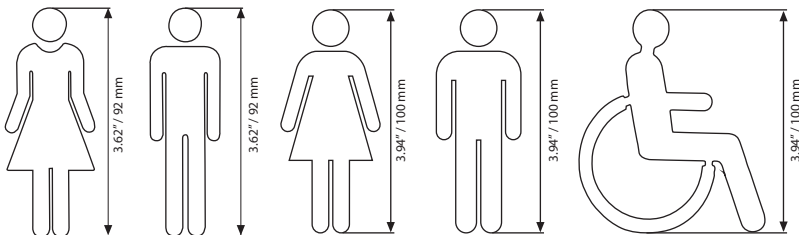

| MATERIAL: Chrome | | | WEIGHT | PACKING SIZE |
|------------------|--------|------------------------|--------------|--------------------------------|
| ARTICLE | HEIGHT | DESCRIPTION | WITH PACKING | *W X H X D |
| TDFJ92X002 | 3.62" | Silver - Men | 0.017 lbs | 5.71" X 7.68" X 4.33" (50 pcs) |
| TDFJ92W002 | 3.62" | Silver - Women | 0.017 lbs | 5.71" X 7.68" X 4.33" (50 pcs) |
| TDFJ100X01 | 3.94" | Milky White - Men | 0.030 lbs | 6.89" X 7.87" X 4.33" (50 pcs) |
| TDFJ100W01 | 3.94" | Milky White - Women | 0.030 lbs | 6.89" X 7.87" X 4.33" (50 pcs) |
| TDFJ100C01 | 3.94" | Milky White - Handicap | 0.028 lbs | 6.89" X 7.87" X 4.33" (50 pcs) |

*W:Width H: Height D: Depth



Decorative Toilet Signs



Oval shape plastic injected toilet signs has both colour and size options: Gold, Silver and Bronze & 4.72" and 5.91" heights. Braided frame and leather-textured backing completes elegant look.

Peel the tape and stick backing for easy application. Please clean the surface before applying the double-sided tape for better application.



Silver Frame, Dark Grey Panel, Men



Silver Frame, Dark Grey Panel, Women



Gold Frame, Dark Grey Panel, Men



Gold Frame, Dark Grey Panel, Women



Bronze Frame, Dark Grey Panel, Men



Bronze Frame, Dark Grey Panel, Women



Double sided tape

Back

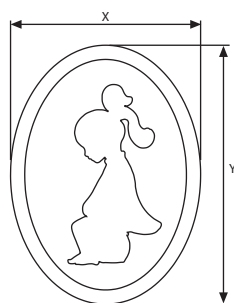
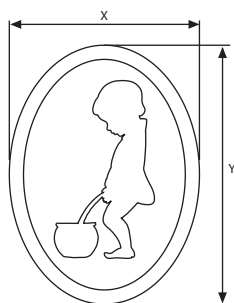

| MATERIAL: Plastic injected | | | WEIGHT | PACKING SIZE |
|----------------------------|----------------|----------------|--------------|---------------------------------|
| ARTICLE | EXTERNAL (x-y) | DESCRIPTION | WITH PACKING | *W X H X D |
| TDFY28LF03 | 3.46" X 4.72" | Gold - Men | 0.088 lbs | 8.07" X 9.45" X 6.69" (50 pcs) |
| TDFY28WF03 | 3.46" X 4.72" | Gold - Women | 0.088 lbs | 8.07" X 9.45" X 6.69" (50 pcs) |
| TDFY29LF02 | 4.33" X 5.91" | Silver - Men | 0.145 lbs | 9.25" X 12.99" X 6.89" (50 pcs) |
| TDFY29WF02 | 4.33" X 5.91" | Silver - Women | 0.145 lbs | 9.25" X 12.99" X 6.89" (50 pcs) |
| TDFY31LF04 | 4.33" X 5.91" | Bronze - Men | 0.145 lbs | 9.25" X 12.99" X 6.89" (50 pcs) |
| TDFY31WF04 | 4.33" X 5.91" | Bronze - Women | 0.145 lbs | 9.25" X 12.99" X 6.89" (50 pcs) |

*W:Width H: Height D: Depth



Aluminum Panel Braille Signs



Aluminium Braille Toilet Signs are plastic framed. The signs are incorporated a combination of tactile text and printed text. It is available in Men and Women options. Easy to apply with double sided tape provided on the back of each sign.

 Peel the tape and stick backing for easy application. Please clean the surface before applying the double-sided tape for better application.

5"x5" Aluminium Panel Braille Signs



5" x 5" - No Smoking, Silver Plastic Frame Aluminum Panel With Braille

6"x8" Aluminium Panel Braille Signs



6" x 8" - Men, Silver Plastic Frame Aluminum Panel With Braille



6" x 8" - Female, Silver Plastic Frame Aluminum Panel With Braille

6"x6" Aluminium Panel Braille Signs



6" x 6" - Men, Silver Plastic Frame Aluminum Panel With Braille



6" x 6" - Female, Silver Plastic Frame Aluminum Panel With Braille



5"x5" Aluminium Panel Braille Signs



6"x6" Aluminium Panel Braille Signs

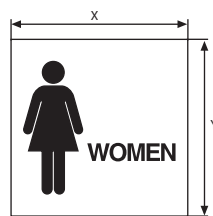

6"x8" Aluminium Panel Braille Signs

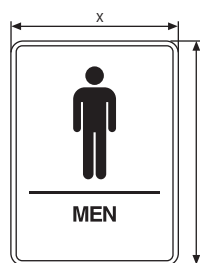

| 5"x5": Aluminium | | | WEIGHT | PACKING SIZE |
|--------------------|----------------|----------------|--------------|---------------------------------|
| ARTICLE | EXTERNAL (x-y) | DESCRIPTION | WITH PACKING | *W X H X D |
| TDFL110002 | 5" X 5" | Silver | 0.145 lbs | 9.25" X 16.54" X 8.07" (50 pcs) |
| 6" X 8": Aluminium | | | WEIGHT | PACKING SIZE |
| ARTICLE | EXTERNAL (x-y) | DESCRIPTION | WITH PACKING | *W X H X D |
| TDFL070002 | 6" X 8" | Silver- Men | 0.313 lbs | 9.25" X 16.54" X 8.07" (50 pcs) |
| TDFL080002 | 6" X 8" | Silver - Women | 0.313 lbs | 9.25" X 16.54" X 8.07" (50 pcs) |
| 6" X 6": Aluminium | | | WEIGHT | PACKING SIZE |
| ARTICLE | EXTERNAL (x-y) | DESCRIPTION | WITH PACKING | *W X H X D |
| TDFL050002 | 6" X 6" | Silver- Men | 0.246 lbs | 9.25" X 16.54" X 8.07" (50 pcs) |
| TDFL060002 | 6" X 6" | Silver - Women | 0.246 lbs | 9.25" X 16.54" X 8.07" (50 pcs) |

* W:Width H: Height D: Depth



ABS Plastic Braille Signs



Chrome framed Braille Signs are made of plastics. The signs incorporated a combination of tactile text and printed text. It has Men, Women, No Smoking and Exit options. Easy to apply with self-adhesive tape provided on the back of each sign.

 Peel the tape and stick backing for easy application. Please clean the surface before applying the double-sided tape for better application.



WOMEN, Braille signs. With double-side tape on the back.



MEN, Braille signs. With double-side tape on the back.



EXIT, braille signs. With double-side tape on the back.



NO SMOKING, braille signs. With double-side tape on the back.

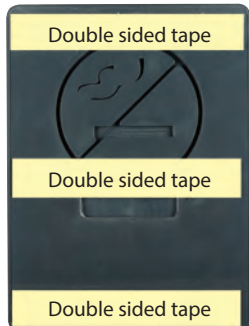

Back side

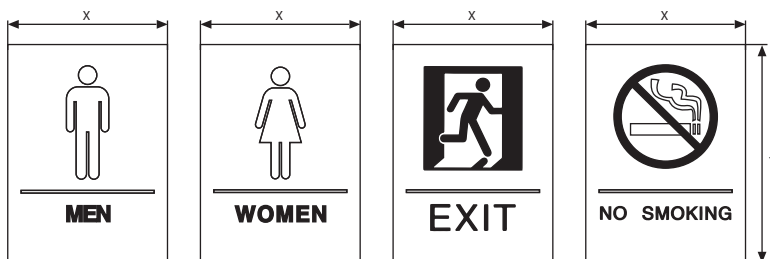

| MATERIAL: Aluminium | | | WEIGHT | PACKING SIZE |
|---------------------|----------------|---------------------|--------------|---------------------------------|
| ARTICLE | EXTERNAL (x-y) | DESCRIPTION | WITH PACKING | *W X H X D |
| TDFY010002 | 6" X 8" | Silver - Men | 0.396 lbs | 9.25" X 12.99" X 9.25" (50 pcs) |
| TDFY020002 | 6" X 8" | Silver - Women | 0.396 lbs | 9.25" X 12.99" X 9.25" (50 pcs) |
| TDFY090002 | 6" X 8" | Silver - No Smoking | 0.396 lbs | 9.25" X 12.99" X 9.25" (50 pcs) |
| TDFY100002 | 6" X 8" | Silver - Exit | 0.396 lbs | 9.25" X 12.99" X 9.25" (50 pcs) |

*W:Width H:Height D:Depth



Plastic Chromed House Numbers



Chrome coated plastic House Numbers offered in a pack 0-9. Easy to apply on various surfaces with self-adhesive tape on the back of each sign.

 Peel the tape and stick backing for easy application.

 One pack includes 0-9.

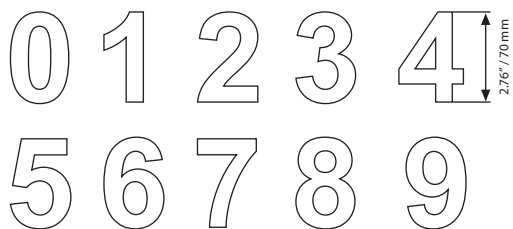

| MATERIAL: Chrome coated plastic | | | WEIGHT | PACKING SIZE |
|---------------------------------|--------|--------------|--------------|-----------------------------------|
| ARTICLE | HEIGHT | DESCRIPTION | WITH PACKING | *W X H X D |
| TDFH700002 | 2.76" | Silver - 0-9 | 0.030 lbs | 10.04" X 12.20" X 13.19" (50 pcs) |

* W:Width H: Height D: Depth



Fast Note



See movie at our website www.mtdisplays.com.tr

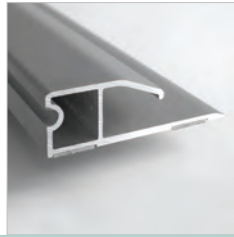

Fast Note is a product which enables you to hang your papers, notes, pictures or photos without magnets or pins. It has a slim and compact design. Thanks to the cylinders in the profile you can easily keep the paper inside. Fast Note is suitable for restaurants, agencies, studios, hospitals, hotels, conference rooms, houses and offices. The standard color is anodized silver. Other colors and sizes are available upon request. You can either assemble the product on the wall by fixing the holes on the profile with screws and wall-plugs or apply the double-sided tape at any given point.

It is user friendly. Fixing set (screw and double-sided tape) and manual is supplied with each product. Suitable for use of posters / paper min. 0.003", max. 0.0314" thickness.

! Suitable for silk screen printing, max. letter height is 0.55".

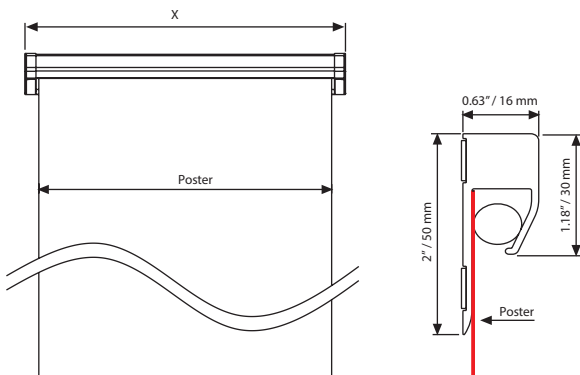

| MATERIAL : Silver anodised aluminium | | WEIGHT | PACKING SIZE |
|--------------------------------------|--------------|--------------|---|
| ARTICLE | EXTERNAL (x) | WITH PACKING | *W X H X D |
| UFN000N012 | 12.98" | 12" | 17.636 lbs 8.66" X 14.17" X 12.60" (50 pcs) |
| UFN000N024 | 24.98" | 24" | 35.273 lbs 8.66" X 26.38" X 12.60" (50 pcs) |
| UFN000N036 | 36.98" | 36" | 26.455 lbs 7.09" X 38.39" X 8.66" (25 pcs) |
| UFN000N040 | 40.98" | 40" | 28.660 lbs 7.09" X 42.32" X 8.66" (25 pcs) |
| UFN000N060 | 60.98" | 60" | 41.887 lbs 7.09" X 62.60" X 8.66" (25 pcs) |



*W:Width H: Height D: Depth



Magnetic Glass Board



Both magnetic and dry wipe, Magnetic Glass Board offers a smart solution for offices, colleagues, meeting rooms, hotels, cafes and more. Red, Black and White colour options will suit various contemporary decoration. Tempered glass increases the strength against damages. Magnets, pen holder, eraser and pen included in the pack for comfortable immediate use.

-  Each unit is packed individual in carton box.
-  Landscape/portrait wall mounting.
-  Accessories (rubber&marker&magnets) are included in the original box.

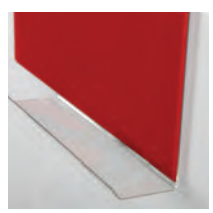
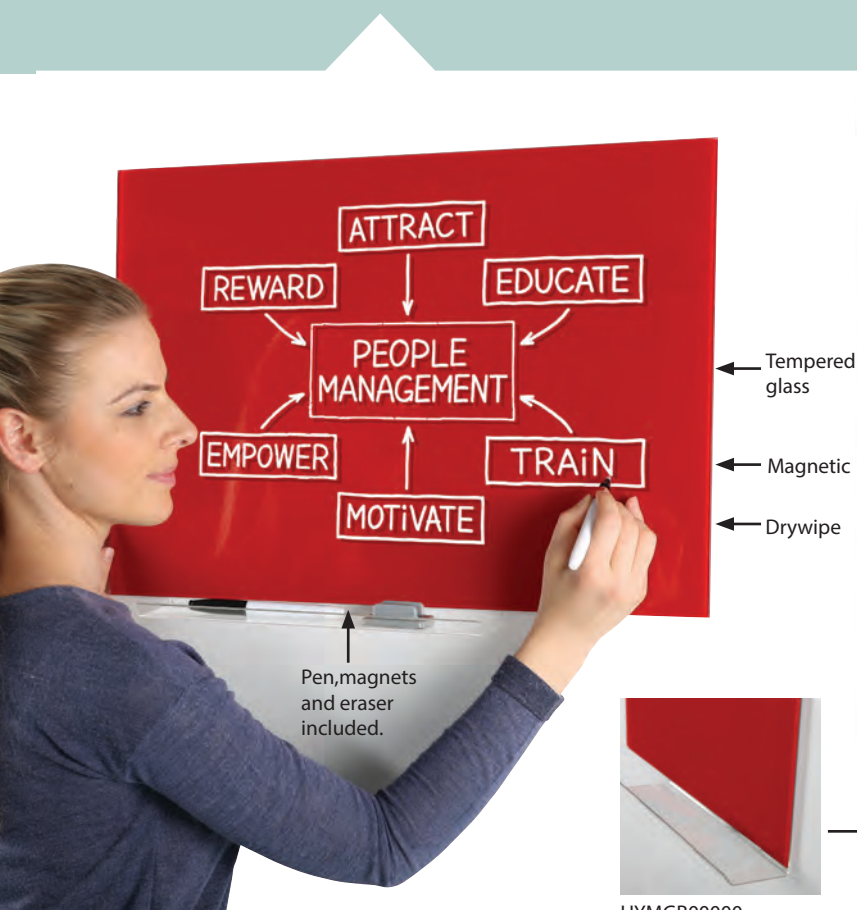

UYMGB00000
Shelves are optional accessories.

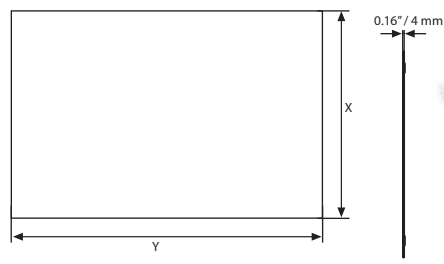

| MATERIAL : Tempered glass | | | WEIGHT | PACKING SIZE |
|---------------------------|-----------------|--------|--------------|-------------------------|
| ARTICLE | SIZE (x-y) | COLOUR | WITH PACKING | *W X H X D |
| T00MGB0345 | 17.72" X 17.72" | White | 5.820 lbs | 18.90" X 19.29 X 1.77" |
| T00MGB0145 | 17.72" X 17.72" | Black | 5.820 lbs | 18.90" X 19.29 X 1.77" |
| T00MGB0445 | 17.72" X 17.72" | Red | 5.820 lbs | 18.90" X 19.29 X 1.77" |
| T00MGB0346 | 15.75" X 23.62" | White | 6.878 lbs | 17.32" X 25.20" X 1.77" |
| T00MGB0146 | 15.75" X 23.62" | Black | 6.878 lbs | 17.32" X 25.20" X 1.77" |
| T00MGB0446 | 15.75" X 23.62" | Red | 6.878 lbs | 17.32" X 25.20" X 1.77" |
| T00MGB0369 | 23.62" X 35.43" | White | 15.873 lbs | 26.77" X 38.58" X 1.77" |
| T00MGB0169 | 23.62" X 35.43" | Black | 15.873 lbs | 26.77" X 38.58" X 1.77" |
| T00MGB0469 | 23.62" X 35.43" | Red | 15.873 lbs | 26.77" X 38.58" X 1.77" |

*W:Width H: Height D: Depth



Business Card Holder

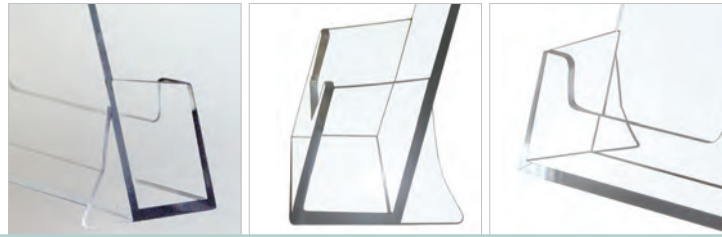

The clear Business Card Holder is good to organize your business and a perfect tool for professional appearance. This card holder is available in stock, ready for shipment and boxed in 40's.

! Please handle with care during transportation.



Clear

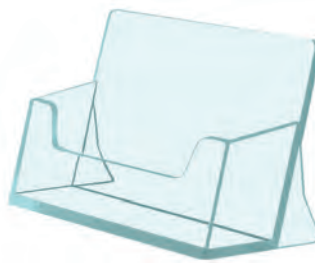

Turquoise

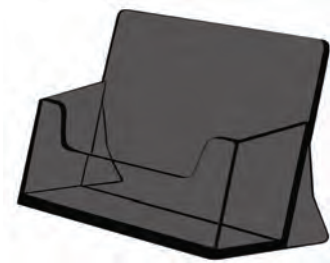

Black

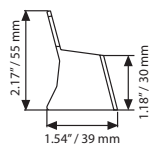
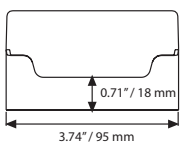
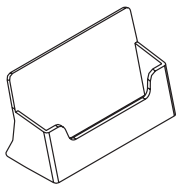

| MATERIAL : Clear | | WEIGHT | PACKING SIZE |
|------------------|-------------|--------------|---------------------------------|
| ARTICLE | DESCRIPTOIN | WITH PACKING | *W X H X D |
| UMSD009000 | Clear | 2.843 lbs | 9.65" X 13.78" X 3.39" (40 pcs) |
| UMSD009B00 | Black | 2.843 lbs | 9.65" X 13.78" X 3.39" (40 pcs) |
| UMSD009T00 | Turquoise | 2.843 lbs | 9.65" X 13.78" X 3.39" (40 pcs) |



*W:Width H: Height D: Depth

Coat Racks

Designed for beauty and function, these coat racks are suitable for home or office use. 8 different models are offered with different accessories and functions. All models are heavy and sturdy for stability. They support up to 55.115 lbs in average.

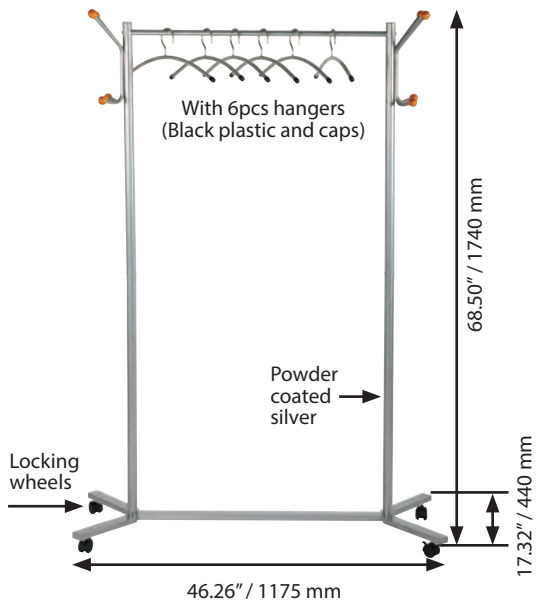

Coat Hanger Stand



| MATERIAL : Steel | | WEIGHT | PACKING SIZE |
|------------------|--------------------------|-------------|------------------------------------|
| ARTICLE | SIZE | DESCRIPTION | *W X H X D |
| TWJD000303 | 46.26" X 17.32" X 68.50" | Silver | 12.345 lbs 35.04" X 12.01" X 3.54" |



* W:Width H: Height D: Depth

Trio Coat Rack

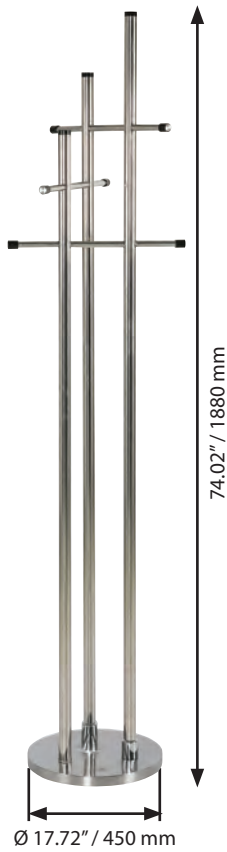

Spring Coat Rack

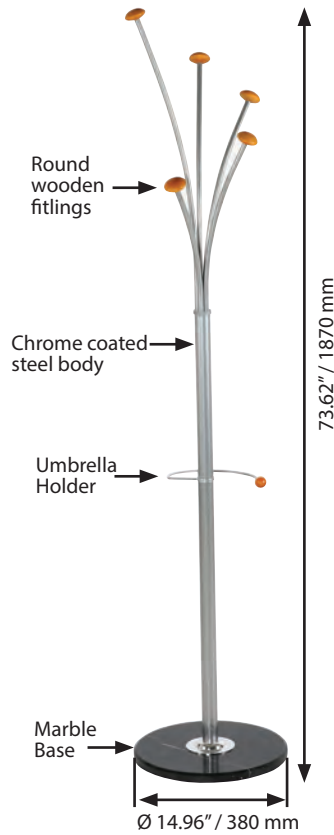

| TRIO: Steel | | | WEIGHT | PACKING SIZE |
|-------------|-------------------------|-------------|--------------|-------------------------|
| ARTICLE | SIZE | DESCRIPTION | WITH PACKING | *W X H X D |
| TXXY809A01 | 17.72" X 1.77" X 74.02" | Silver | 20.502 lbs | 73.62" X 4.33" X 1.97" |
| | | | | 16.14" X 16.14" X 1.97" |



- Black knob accessories
- Packaging: single packed
- Easy assembling
- Gross weight: 20.502 lbs.

2 packs. See info chart for pack sizes.



| SPRING: Steel | | | WEIGHT | PACKING SIZE |
|---------------|--------------------------|-------------|--------------|-------------------------|
| ARTICLE | SIZE | DESCRIPTION | WITH PACKING | *W X H X D |
| TWJD856003 | 14.96" X 14.96" X 73.62" | Silver | 20.723 lbs | 28.35" X 15.24" X 3.46" |



* W:Width H: Height D: Depth

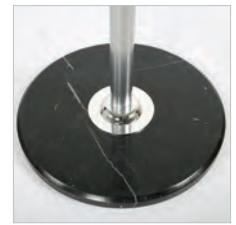
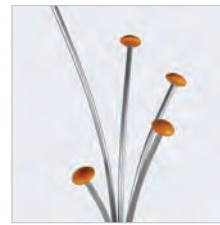

Pine Coat Rack

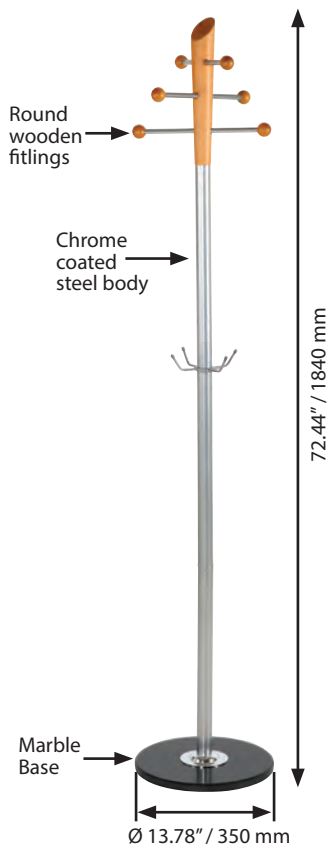

Sunflower Coat Rack

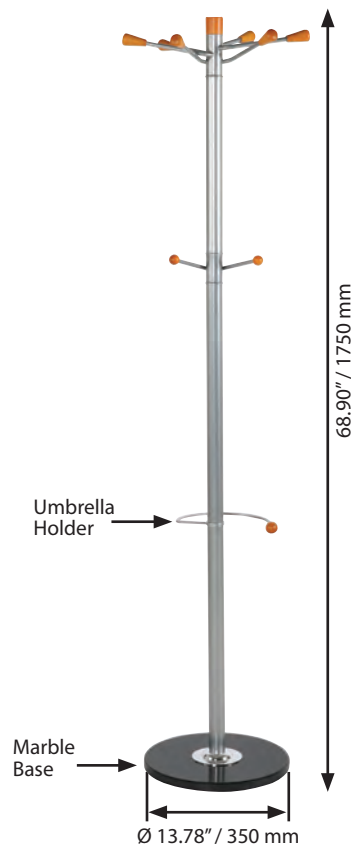

| PINE: Steel | | | WEIGHT | PACKING SIZE |
|-------------|--------------------------|-------------|--------------|-------------------------|
| ARTICLE | SIZE | DESCRIPTION | WITH PACKING | *W X H X D |
| TWJD824403 | 13.78" X 13.78" X 68.90" | Silver | 17.857 lbs | 23.23" X 14.37" X 5.31" |



* W:Width H: Height D: Depth



| SUNFLOWER: Steel | | | WEIGHT | PACKING SIZE |
|------------------|--------------------------|-------------|--------------|-------------------------|
| ARTICLE | SIZE | DESCRIPTION | WITH PACKING | *W X H X D |
| TWJD824403 | 13.78" X 13.78" X 72.44" | Silver | 17.416 lbs | 20.47" X 14.06" X 3.62" |



* W:Width H: Height D: Depth



Fountain Coat Rack

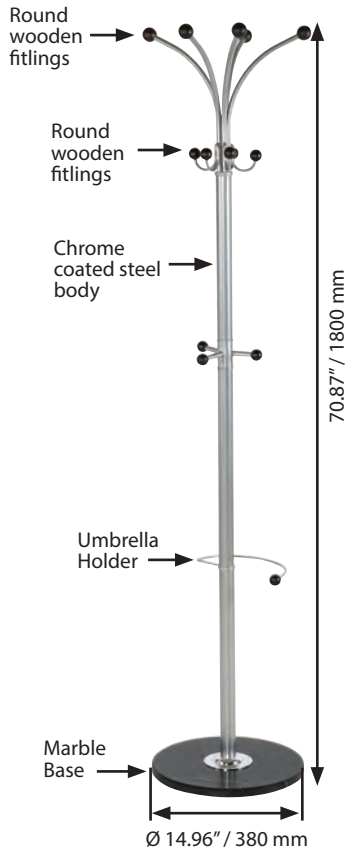

Ladder Coat Rack

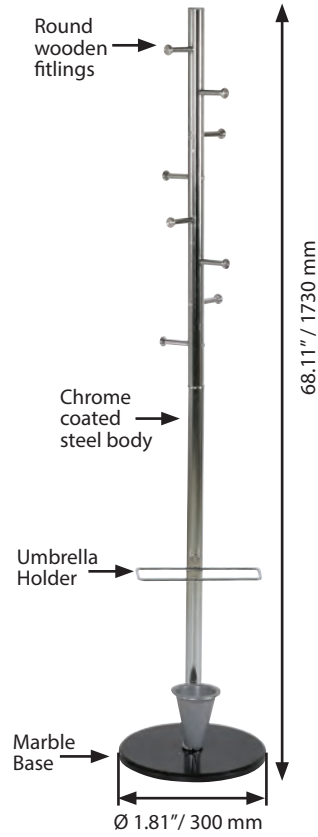

| FOUNDATION : Steel | | | WEIGHT | PACKING SIZE |
|--------------------|--------------------------|-------------|--------------|-------------------------|
| ARTICLE | SIZE | DESCRIPTION | WITH PACKING | *W X H X D |
| TWJD888003 | 14.96" X 14.96" X 70.87" | Silver | 21.384 lbs | 23.23" X 15.24" X 3.74" |



* W:Width H: Height D: Depth



| LADDER : Steel | | | WEIGHT | PACKING SIZE |
|----------------|--------------------------|-------------|--------------|-------------------------|
| ARTICLE | SIZE | DESCRIPTION | WITH PACKING | *W X H X D |
| TWJD828103 | 11.81" X 11.81" X 68.11" | Silver | 15.652 lbs | 34.65" X 12.20" X 4.72" |



* W:Width H: Height D: Depth



Maze Coat Rack

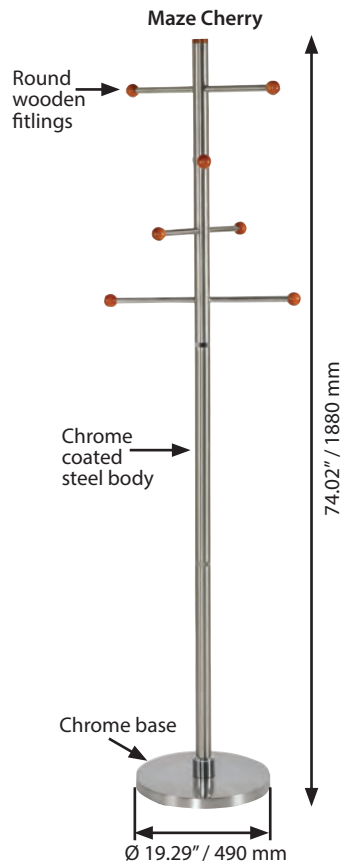
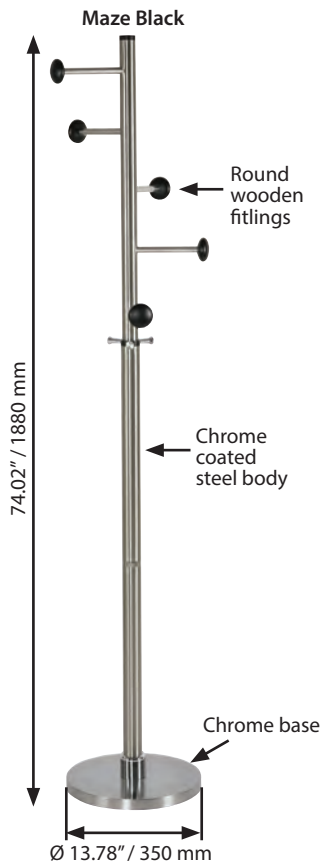

| MAZE : Steel | | | WEIGHT | PACKING SIZE |
|--------------|--------------------------|-------------|--------------|-------------------------|
| ARTICLE | SIZE | DESCRIPTION | WITH PACKING | *W X H X D |
| TXXY801001 | 19.29" X 19.29" X 74.02" | Cherry | 14.550 lbs | 28.15" X 3.54" X 14.76" |
| TXXY808A01 | 13.78" X 13.78" X 74.02" | Black | 14.991 lbs | 28.15" X 3.54" X 14.76" |



* W:Width H: Height D: Depth

- Cherry wood or black knob accessoires
- Packaging: single packed
- Easy assembling
- Gross weight: 14.550 lbs.



Waste Baskets

These Waste Baskets are mainly made of stainless steel for hygienic reasons. All models easily incorporate in contemporary office buildings, lounges, lobby or at an entryway to promote paper litter disposal. Available in different capacities, finishes and functions.



Flat Pedal Trash Can

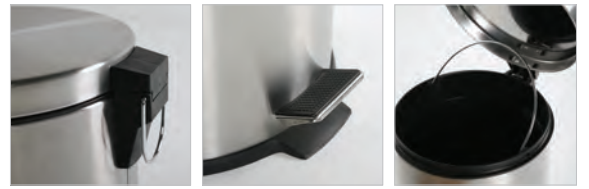
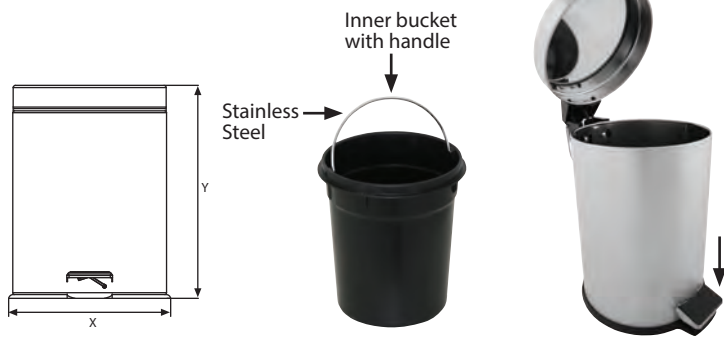

| MATERIAL : Stainless Steel | | | | WEIGHT | PACKING SIZE |
|----------------------------|------------------|-------------|-----------|--------------|--------------------------|
| ARTICLE | SIZE (x-y) | DESCRIPTION | CAPACITY | WITH PACKING | *W X H X D |
| TJIPT90A01 | Ø6.61" X 10.16" | Silver | 101 ounce | 2.131 lbs | 7.48" X 10.63" X 10.24" |
| TJIPT90B01 | Ø8.07" X 10.63" | Silver | 169 ounce | 2.718 lbs | 9.06" X 11.81" X 11.81" |
| TJIPT90C01 | Ø12.01" X 17.72" | Silver | 676 ounce | 7.054 lbs | 12.99" X 15.75" X 18.90" |

*W:Width H: Height D: Depth



676 ounce - Stainless Steel

169 ounce - Stainless Steel

101 ounce - Stainless Steel

Hotel Trash Can



| MATERIAL : Stainless Steel | | | | WEIGHT | PACKING SIZE |
|----------------------------|------------------|--------------------------|------------|--------------|--------------------------|
| ARTICLE | SIZE (x-y) | DESCRIPTION | CAPACITY | WITH PACKING | *W X H X D |
| TJIHT95A01 | Ø8.07" X 22.83" | Silver | 405 ounce | 4.629 lbs | 9.06" X 23.62" X 9.84" |
| TJIHT95B01 | Ø11.81" X 23.82" | Silver-with inner bucket | 1014 ounce | 8.598 lbs | 12.99" X 25.59" X 12.99" |
| TJIHT95B02 | Ø11.81" X 23.82" | Black-with inner bucket | 1014 ounce | 8.818 lbs | 12.99" X 25.59" X 12.99" |

*W:Width H: Height D: Depth

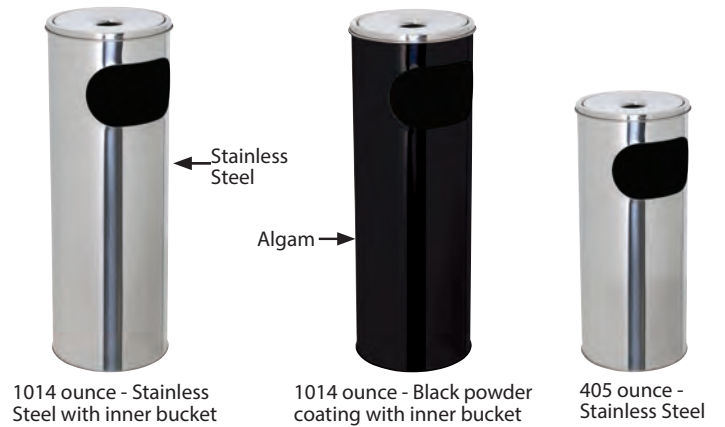

1014 ounce - Stainless Steel with inner bucket

1014 ounce - Black powder coating with inner bucket

405 ounce - Stainless Steel

Hotel Trash Can Inner Bucket

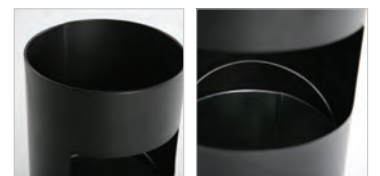

| MATERIAL : Stainless Steel | | | | WEIGHT | PACKING SIZE |
|----------------------------|-----------------|-------------|-----------|--------------|--------------------------|
| ARTICLE | SIZE (x-y) | DESCRIPTION | CAPACITY | WITH PACKING | *W X H X D |
| TJIHT58001 | Ø9.84" X 23.62" | Silver | 608 ounce | 6.834 lbs | 11.02" X 25.20" X 11.02" |
| TJIHT58002 | Ø9.84" X 23.62" | Black | 608 ounce | 6.834 lbs | 11.02" X 25.20" X 11.02" |

*W:Width H: Height D: Depth

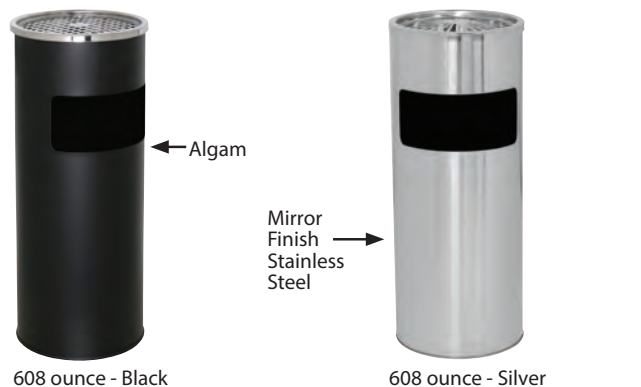

608 ounce - Black

608 ounce - Silver

Stainless Steel Push Can Dust Bin

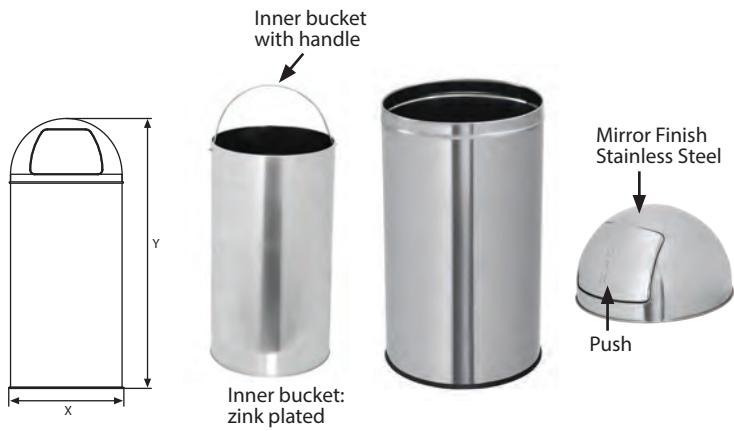

| MATERIAL : Stainless Steel | | | | WEIGHT | PACKING SIZE |
|----------------------------|------------------|-------------|------------|--------------|--------------------------|
| ARTICLE | SIZE (x-y) | DESCRIPTION | CAPACITY | WITH PACKING | *W X H X D |
| TJIDB96A01 | Ø8.07" X 23.62" | Silver | 845 ounce | 7.716 lbs | 11.02" X 25.20" X 11.02" |
| TJIDB96B01 | Ø11.61" X 25.98" | Silver | 1183 ounce | 9.369 lbs | 12.99" X 25.59" X 12.99" |
| TJIDB96C01 | Ø13.78" X 29.92" | Silver | 1690 ounce | 13.668 lbs | 14.96" X 32.50" X 14.96" |

*W:Width H: Height D: Depth



Stainless Steel Waste Basket Singel Wall

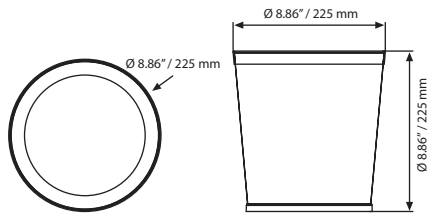

| MATERIAL : Stainless Steel | | | WEIGHT | PACKING SIZE |
|----------------------------|-------------|-----------|--------------|------------------------|
| ARTICLE | DESCRIPTION | WEIGHT | WITH PACKING | *W X H X D |
| TJIWB93S01 | Silver | 1.653 lbs | 2.425 lbs | 9.84" X 11.42" X 9.84" |
| TJIWB93S02 | Black | 1.653 lbs | 2.425 lbs | 9.84" X 11.42" X 9.84" |

*W:Width H: Height D: Depth



Stainless Steel Waste Basket Double Wall

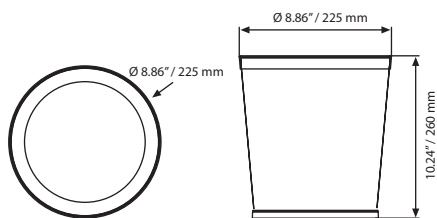

| MATERIAL : Stainless Steel | | | WEIGHT | PACKING SIZE |
|----------------------------|-------------|-----------|--------------|------------------------|
| ARTICLE | DESCRIPTION | WEIGHT | WITH PACKING | *W X H X D |
| TJIWB93D01 | Silver | 2.645 lbs | 3.141 lbs | 9.84" X 11.81" X 9.84" |
| TJIWB93D02 | Black | 2.645 lbs | 3.527 lbs | 9.84" X 11.81" X 9.84" |

*W:Width H: Height D: Depth



2 Step Stepstool



See movie at our website www.mtdisplays.com.tr



Stay safe while reaching higher places at office, library, shops or even at home. 2-Step Plastic Stepstool is a tool that can be easily used and available in 4 colors (Black, Red, Blue, Grey) to match your decoration. It tolerates up to 330.693 lbs without losing its looks. Can be easily moved around with spring loaded castors. Made from durable PP material.

- Easily moved by the rollers.
- Available in 4 colours : black, blue, grey, red.
- Maximum loading capacity 330.693 lbs.
- Assembly in 4 seconds.



UPSS200002
Grey



UPSS200003
Red

← Antislip surface.



Max. load 330.693 lbs



UPSS200001
Black



UPSS200004
Blue



Antislip rubber base. Locking wheel system.

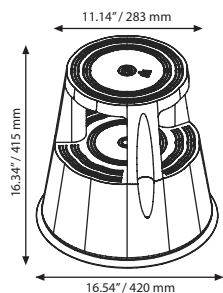

| MATERIAL : PP | | WEIGHT | PACKING SIZE |
|---------------|-------------|--------------|-------------------------|
| ARTICLE | DESCRIPTION | WITH PACKING | *W X H X D |
| UPSS200001 | Black | 5.401 lbs | 17.13" X 17.13" X 9.45" |
| UPSS200002 | Grey | 5.401 lbs | 17.13" X 17.13" X 9.45" |
| UPSS200003 | Red | 5.401 lbs | 17.13" X 17.13" X 9.45" |
| UPSS200004 | Blue | 5.401 lbs | 17.13" X 17.13" X 9.45" |

*W:Width H: Height D: Depth



Office Products





Presentation Systems

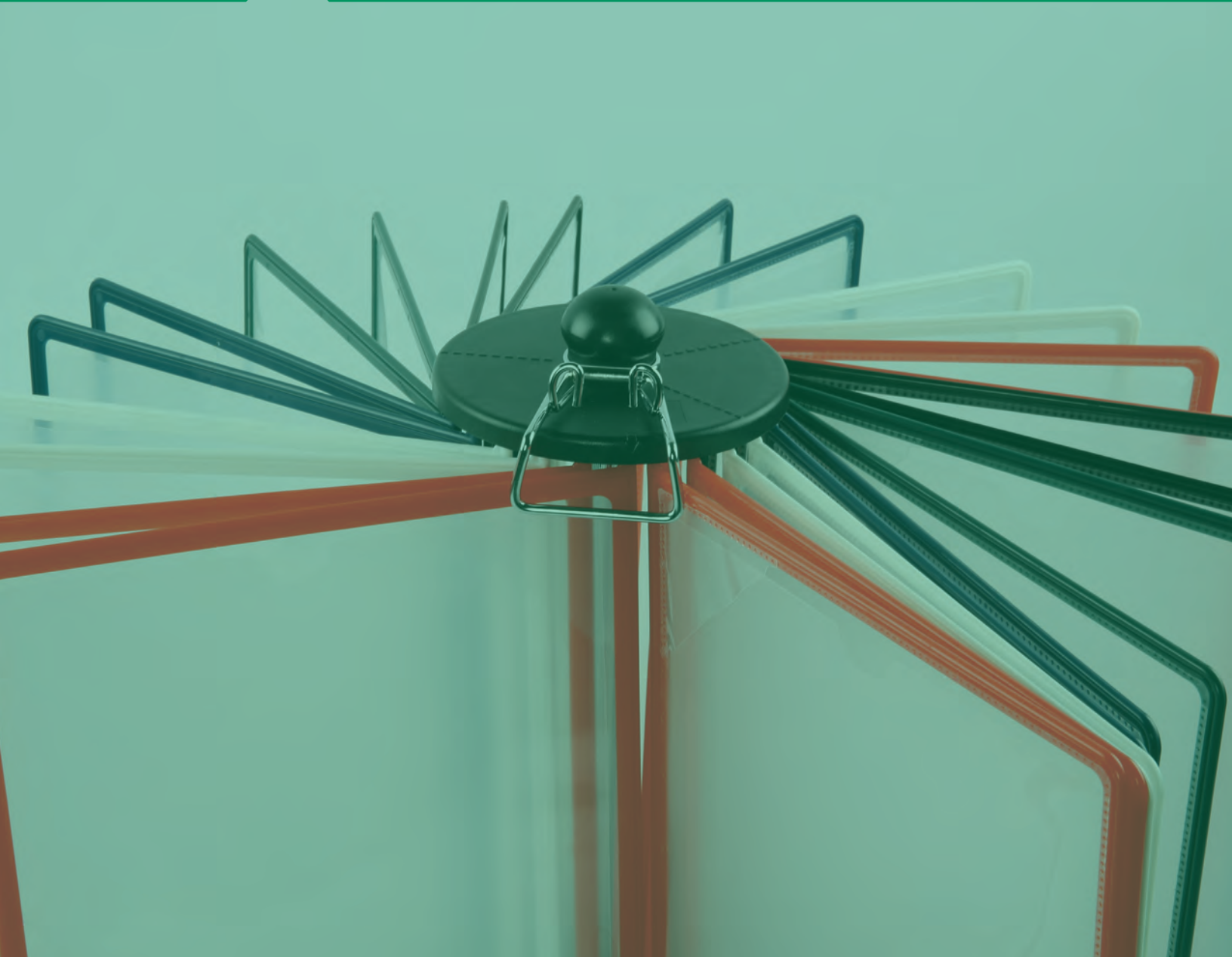

- White Boards
- Map Boards
- Reference Racks
 - Table Top Reference Rack
 - Adjustable Reference Rack System
 - Adjustable Reference Rack with Round Base
 - 360° Rotating Reference Rack
 - Flexible Reference Rack System
 - Wall Mount Reference Rack Plastic
 - Wall Reference Rack
 - Free Standing Reference Rack
 - Floor Standing Reference Rack
- Flipcharts
 - Adjustable Flipchart
 - Reversible Flipchart
 - Mobile Plus Flipchart
 - Professional Mobile Flipchart
- Easels
 - Modern Easel
 - Art Easel
 - Basic Easel
 - Portable Easel



Rotatable Model White Boards Magnetic & Dry Wipe Double Sided



Double sided magnetic drywipe and revolving Whiteboard which offers one side plain smooth surface and the other side allows inserting papers together with drywipe surface. Sturdy Aluminium framed Whiteboards available in large sizes for presentations, training rooms, hanging artworks, maps and charts. The Fast Note on the other side allows inserting various sheets of paper and it is held in place with specially designed rollers. Easy to move the board with locking wheels.

-  For use with drywipe pens. Each board includes a set of magnets.
-  Fast Note is ideal for 0,10-0,80mm thicknesses of materials.
-  Accessories (erase & marker) are not included.

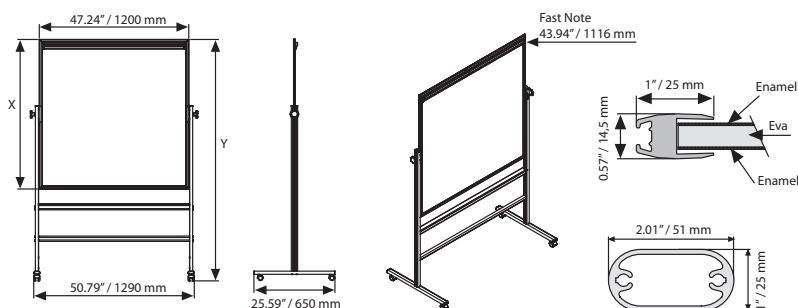

| PET POCKET: Magnetic | | WEIGHT | PACKING SIZE (10 Pcs) |
|----------------------|---------------------------|--------------|------------------------|
| ARTICLE | DESCRIPTION | WITH PACKING | *W X H X D |
| UPCMOR00A4 | Magnetic 8.5" X 11" Red | 0.881 lbs | 9.84" X 13.78" X 0.83" |
| UPCMOB00A4 | Magnetic 8.5" X 11" Black | 0.881 lbs | 9.84" X 13.78" X 0.83" |
| UPCMOW00A4 | Magnetic 8.5" X 11" White | 0.881 lbs | 9.84" X 13.78" X 0.83" |
| UPCMOG00A4 | Magnetic 8.5" X 11" Gray | 0.881 lbs | 9.84" X 13.78" X 0.83" |

| MATERIAL : Clear | | | WEIGHT | PACKING SIZE |
|------------------|--------------|--------|--------------|--------------------------|
| ARTICLE | EXTERNAL (x) | Y | WITH PACKING | *W X H X D |
| UWBDon1290 | 35.43" | 70.35" | 33.289 lbs | 11.42" X 12.99" X 7.87" |
| UWBDon1212 | 47.24" | 76.26" | 39.793 lbs | 13.39" X 14.17" X 9.06" |
| UWBDon1215 | 59.06" | 88.07" | 48.942 lbs | 16.93" X 21.26" X 12.99" |



*W:Width H: Height D: Depth

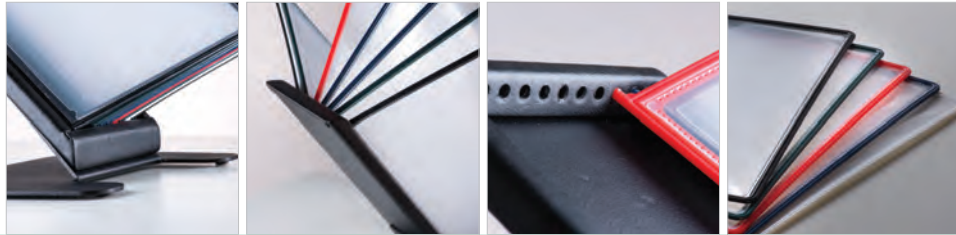
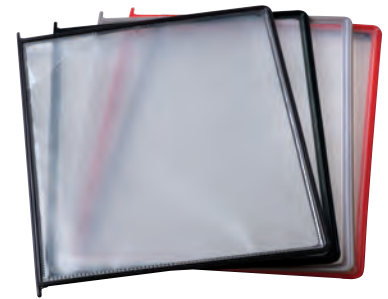

Table Top Reference Rack



Steel stand with PET pockets, Table Top Reference Rack allows you to organize busy environments. Do not forget to order pockets separately. Pockets are double sided, allowing you to display 20 pages at a time. The table top reference rack features a black sturdy steel body.

-  Holds 10 pockets at a time in one rack.
-  Pockets should be ordered separately.
- Pockets available in Red, Black and Grey.



Please don't forget to order.
10 pcs of 1 colour in a box.

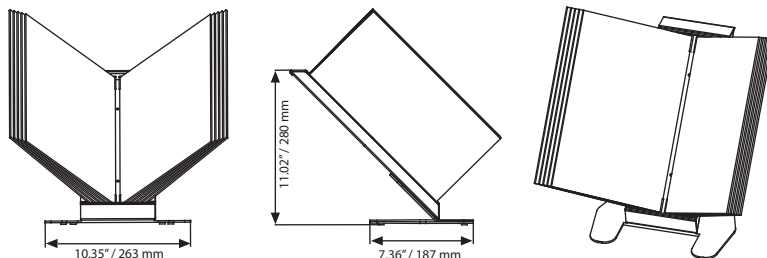

| MATERIAL : Silver anodised aluminium | | | WEIGHT | PACKING SIZE |
|--------------------------------------|------------|-------------|--------------|-------------------------|
| ARTICLE | PAPER SIZE | DESCRIPTION | WITH PACKING | *W X H X D |
| URK01N0081 | 8.5" X 11" | Silver | 1.069 lbs | 11.42" X 18.90" X 6.30" |
| URK01B0081 | 8.5" X 11" | Black | 1.069 lbs | 11.42" X 18.90" X 6.30" |

| POSTER POCKET | | | WEIGHT | PACKING SIZE(10 Pcs) |
|---------------|------------|-------------|--------------|--------------------------|
| ARTICLE | PAPER SIZE | DESCRIPTION | WITH PACKING | *W X H X D |
| TAB0590104 | 8.5" X 11" | Red | 1.212 lbs | 15.35" X 21.65" X 23.23" |
| TAB0590101 | 8.5" X 11" | Black | 1.212 lbs | 15.35" X 21.65" X 23.23" |
| TAB0590109 | 8.5" X 11" | Grey | 1.212 lbs | 15.35" X 21.65" X 23.23" |

* W:Width H: Height D: Depth





Adjustable Reference Rack System

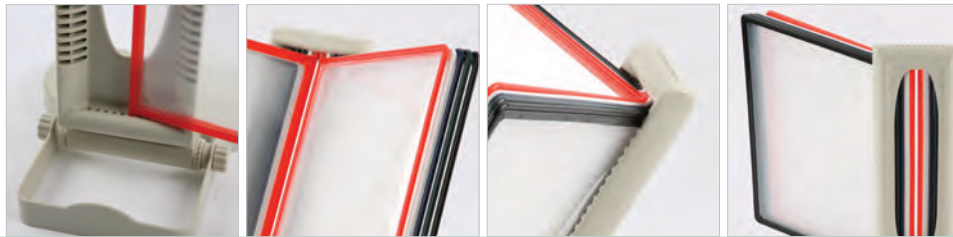

See movie at our website www.mtdisplays.com.tr



Heavy base Adjustable Rack System has capacity of 10 display pockets. It allows adjusting the angle to comfortable eye level. 10 x pockets are included in the system.

-  Holds 10 pockets at a time. Packed unassembled.
-  Sturdy base for a stable and secure unit.
-  Mix colour pockets are included in the pack.

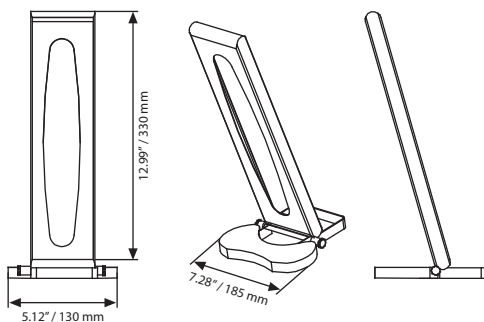

TAB5904003
Tab & Inset. Please don't forget to order.

| MATERIAL : Plastic | | | WEIGHT | PACKING SIZE |
|--------------------|------------|-------------|--------------|--------------------------|
| ARTICLE | PAPER SIZE | DESCRIPTION | WITH PACKING | *W X H X D |
| TAB5898002 | 8.5" X 11" | White | 6.062 lbs | 4.13" X 15.35" X 10.43" |
| POSTER POCKET | | | WEIGHT | PACKING SIZE(10 Pcs) |
| ARTICLE | PAPER SIZE | DESCRIPTION | WITH PACKING | *W X H X D |
| TAB0590104 | 8.5" X 11" | Red | 1.212 lbs | 15.35" X 21.65" X 23.23" |
| TAB0590101 | 8.5" X 11" | Black | 1.212 lbs | 15.35" X 21.65" X 23.23" |
| TAB0590109 | 8.5" X 11" | Grey | 1.212 lbs | 15.35" X 21.65" X 23.23" |

* W:Width H: Height D: Depth



Adjustable Reference Rack with Round Base



See movie at our website www.mtdisplays.com.tr



Adjustable Reference Rack has capacity of 10 display pockets. It has a decorative round base in beige colour which may also serve as organizer for self-stick notes. The pockets are included in the pack index tab & insets should be ordered separately.

Holds 10 pockets at a time in one rack.

Pockets should be ordered separately. Pockets available in Red, Black and Grey.

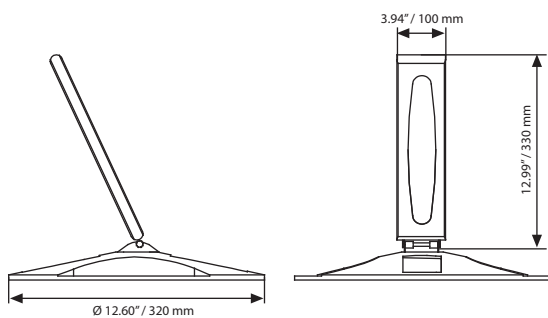
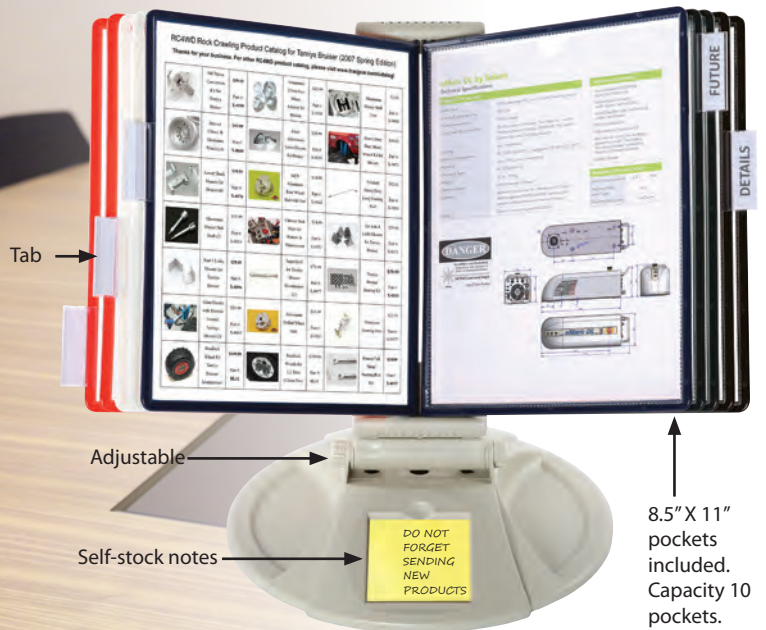

| MATERIAL : Plastic | | | WEIGHT | PACKING SIZE |
|--------------------|------------|-------------|--------------|--------------------------|
| ARTICLE | PAPER SIZE | DESCRIPTION | WITH PACKING | *W X H X D |
| TAB5869002 | 8.5" X 11" | White | 3.571 lbs | 5.31" X 15.35" X 12.80" |
| POSTER POCKET | | | WEIGHT | PACKING SIZE(10 Pcs) |
| ARTICLE | PAPER SIZE | DESCRIPTION | WITH PACKING | *W X H X D |
| TAB0590104 | 8.5" X 11" | Red | 1.212 lbs | 15.35" X 21.65" X 23.23" |
| TAB0590101 | 8.5" X 11" | Black | 1.212 lbs | 15.35" X 21.65" X 23.23" |
| TAB0590109 | 8.5" X 11" | Grey | 1.212 lbs | 15.35" X 21.65" X 23.23" |

* W:Width H: Height D: Depth





360° Rotating Reference Rack

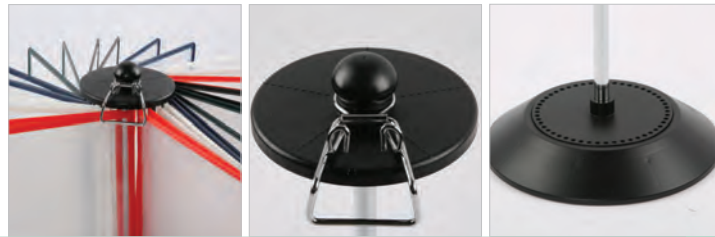

See movie at our website www.mtdisplays.com.tr



360° rotating tabletop reference rack has capacity of 50 display pockets. Pockets and index tabs & insets should be ordered separately. Suitable for places where various information is needed.

-  Holds 50 pockets at a time. Packed unassembled.
-  Sturdy base for a stable and secure unit.
-  Pockets should be ordered separately. Pockets available in Red, Black and Grey.

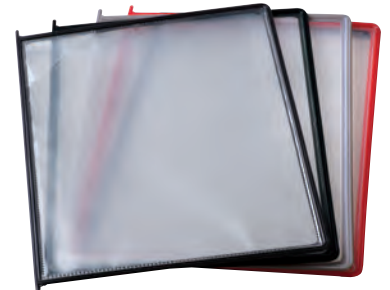
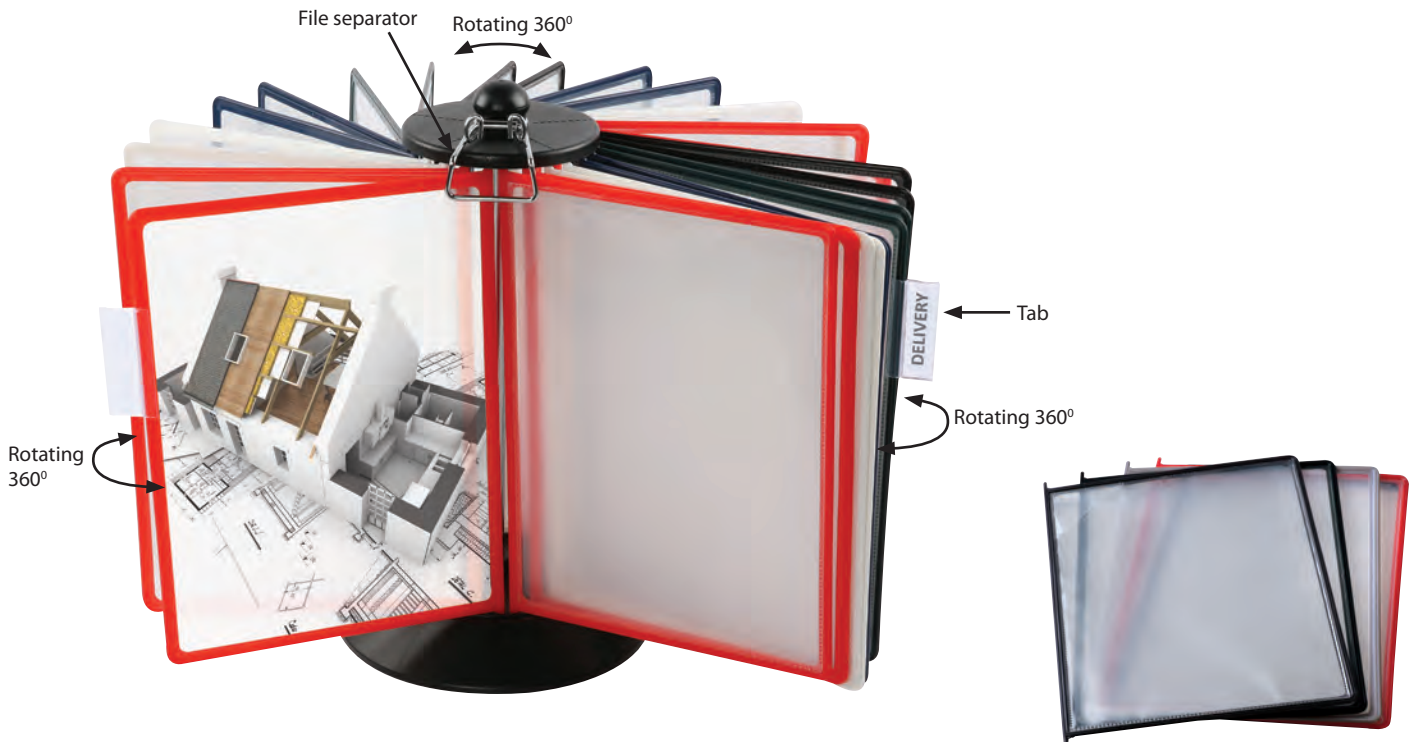

Please don't forget to order. 10 pcs of 1 colour in a box.



Red Black Grey

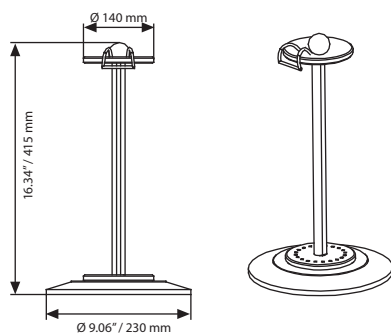

TAB5904003
Tab & Inset. Please don't forget to order.

| MATERIAL : Plastic | | | WEIGHT | PACKING SIZE |
|--------------------|------------|-------------|--------------|--------------------------|
| ARTICLE | PAPER SIZE | DESCRIPTION | WITH PACKING | *W X H X D |
| TAB5896001 | 8.5" X 11" | Black | 5.776 lbs | 10.43" X 16.54" X 10.43" |

| POSTER POCKET | | | WEIGHT | PACKING SIZE (10 Pcs) |
|---------------|------------|-------------|--------------|--------------------------|
| ARTICLE | PAPER SIZE | DESCRIPTION | WITH PACKING | *W X H X D |
| TAB0590104 | 8.5" X 11" | Red | 1.212 lbs | 15.35" X 21.65" X 23.23" |
| TAB0590101 | 8.5" X 11" | Black | 1.212 lbs | 15.35" X 21.65" X 23.23" |
| TAB0590109 | 8.5" X 11" | Grey | 1.212 lbs | 15.35" X 21.65" X 23.23" |

* W:Width H: Height D: Depth



Flexible Reference Rack System



See movie at our website www.mtdisplays.com.tr

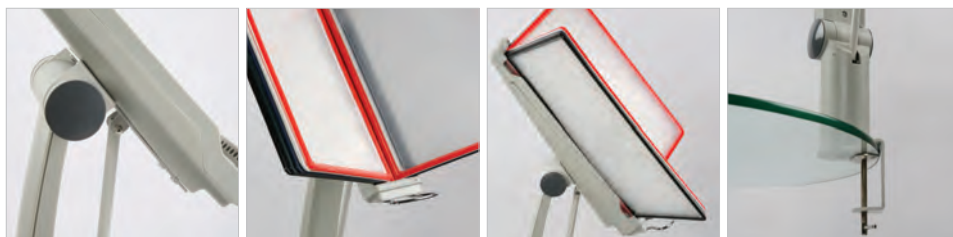

This Reference Rack System is flexible in every means. It can rotate 360 round, height can be adjusted up to 13.98" and the reading angle is adjustable as required. 10 pockets are included in the pack to displays 20 pages at a time.

 Holds 10 pockets at a time in one rack.

 Mix colour pockets are included in the pack.

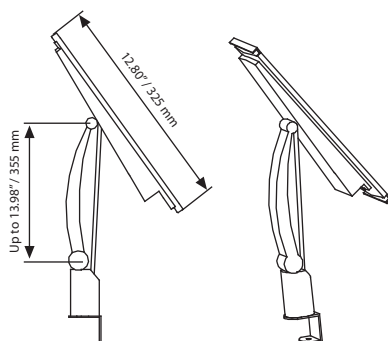
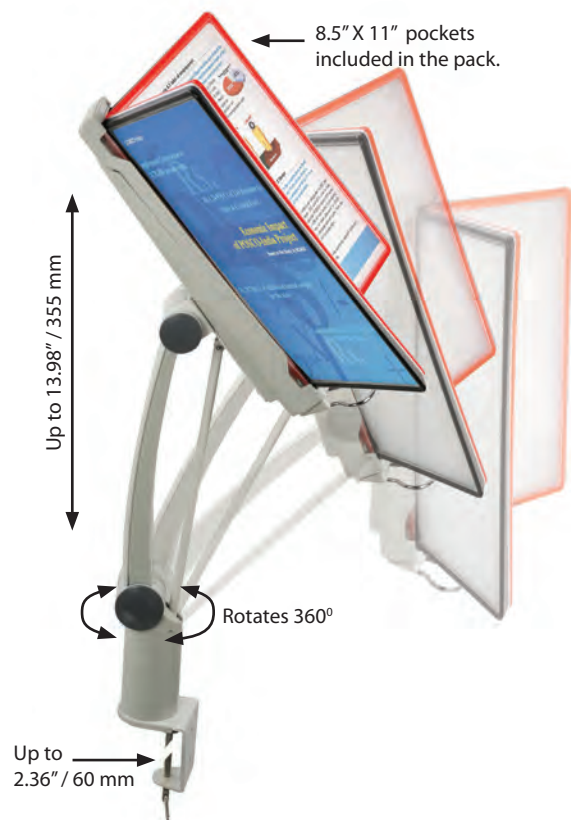

TAB5904003
Tab & Inset. Please don't forget to order.

| MATERIAL : Plastic | | | WEIGHT | PACKING SIZE |
|--------------------|------------|-------------|--------------|-------------------------|
| ARTICLE | PAPER SIZE | DESCRIPTION | WITH PACKING | *W X H X D |
| TAB5846002 | 8.5" X 11" | White | 4.960 lbs | 6.10" X 18.90" X 10.43" |

| POSTER POCKET | | | WEIGHT | PACKING SIZE(10 Pcs) |
|---------------|------------|-------------|--------------|--------------------------|
| ARTICLE | PAPER SIZE | DESCRIPTION | WITH PACKING | *W X H X D |
| TAB0590104 | 8.5" X 11" | Red | 1.212 lbs | 15.35" X 21.65" X 23.23" |
| TAB0590101 | 8.5" X 11" | Black | 1.212 lbs | 15.35" X 21.65" X 23.23" |
| TAB0590109 | 8.5" X 11" | Grey | 1.212 lbs | 15.35" X 21.65" X 23.23" |

*W:Width H: Height D: Depth



Wall Mount Reference Rack Plastic & Steel



Plastic stand with PET pockets, Reference Rack for Wall can be fixed to required height. Wall fixing components and pockets are included in the pack. Light weight, this products is suitable for diffrent office enviroment when space is limited. 10 pockets are included in the pack to displays 20 pages at a time.

- Holds 10 pockets at a time. Packed unassembled.
- Sturdy base for a stable and secure unit.
- Mix colour pockets are included in the pack.

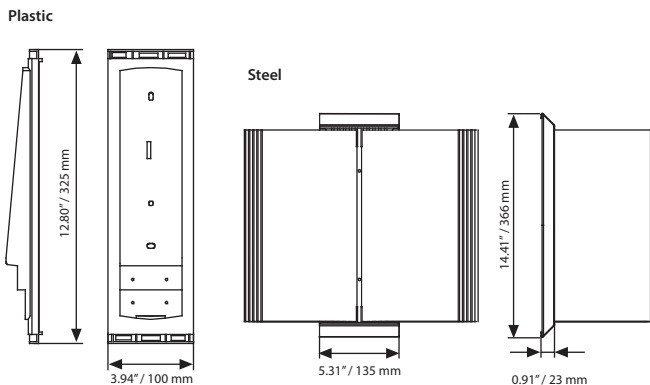
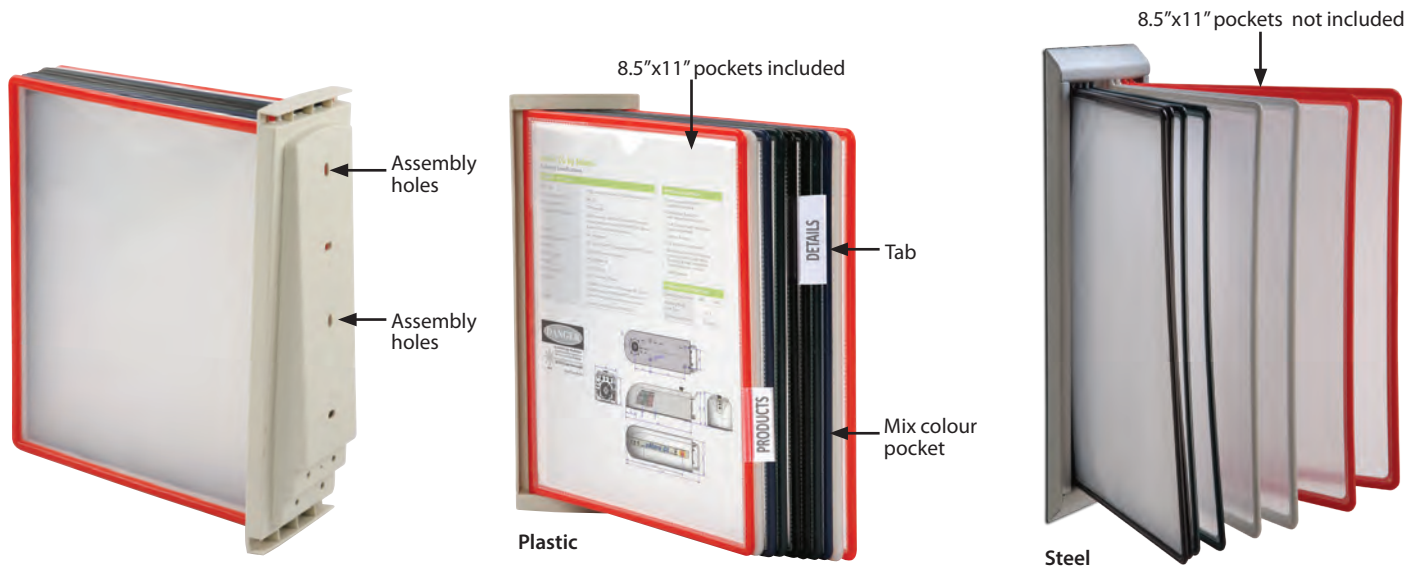

TAB5904003
Tab & Inset.
Please don't forget to order.

| POSTER POCKET | | | WEIGHT | PACKING SIZE(10 Pcs) |
|---------------|------------|-------------|--------------|--------------------------|
| ARTICLE | PAPER SIZE | DESCRIPTION | WITH PACKING | *W X H X D |
| TAB0590104 | 8.5" X 11" | Red | 1.212 lbs | 15.35" X 21.65" X 23.23" |
| TAB0590101 | 8.5" X 11" | Black | 1.212 lbs | 15.35" X 21.65" X 23.23" |
| TAB0590109 | 8.5" X 11" | Grey | 1.212 lbs | 15.35" X 21.65" X 23.23" |

*W:Width H: Height D: Depth

| MATERIAL : Silver anodised aluminium | | | WEIGHT | PACKING SIZE |
|--------------------------------------|------------|-------------|--------------|------------------------|
| ARTICLE | PAPER SIZE | DESCRIPTION | WITH PACKING | *W X H X D |
| URK03N0081 | 8.5" X 11" | Silver | 1.102 lbs | 6.30" X 16.54" X 1.22" |
| URK03B0081 | 8.5" X 11" | Black | 1.102 lbs | 6.30" X 16.54" X 1.22" |

*W:Width H: Height D: Depth

| MATERIAL : Plastic | | | WEIGHT | PACKING SIZE |
|--------------------|------------|-------------|--------------|-------------------------|
| ARTICLE | PAPER SIZE | DESCRIPTION | WITH PACKING | *W X H X D |
| TAB5936002 | 8.5" X 11" | White | 2.204 lbs | 3.74" X 14.96" X 10.43" |

*W:Width H: Height D: Depth

Free Standing Reference Rack



Sturdy aluminum pole with double channels.
 Each pocket displays 2 brochures. Pockets flip easily.
 Do not forget to order pockets separately.
 Hold 10 pockets at the a time. Allows extra frame and brochure holders to add on when need be.

- Holds 10 pockets at a time. Packed unassembled.
- Sturdy base for a stable and secure unit.
- Pockets should be ordered separately. Pockets available in Red, Black and Grey.
- 4 packs. See info chart for pack sizes.

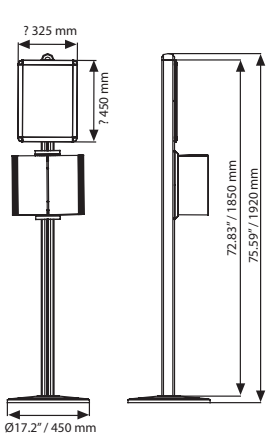
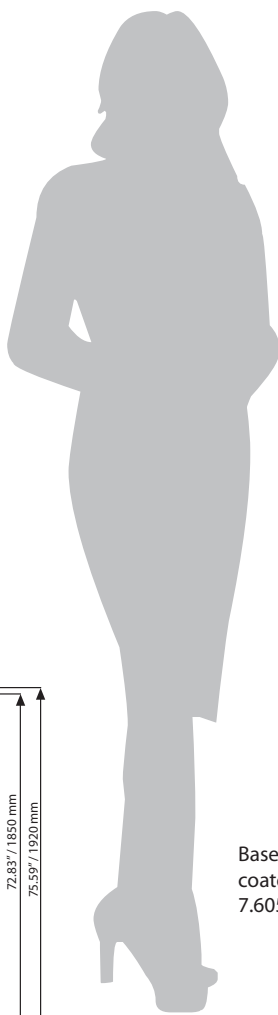

| MATERIAL : Silver anodised aluminium | | | WEIGHT | PACKING SIZE |
|--------------------------------------|------------|-------------|--------------|--|
| ARTICLE | PAPER SIZE | DESCRIPTION | WITH PACKING | *W X H X D |
| URK04N0081 | 8.5" X 11" | Silver | 30.864 lbs | 3.54" X 76.77" X 3.74" / 18.90" X 18.90" X 1.97" |
| URK04B0081 | 8.5" X 11" | Black | 30.864 lbs | 18.11" X 25.98" X 0.83" / 6.30" X 16.54" X 1.22" |
| | | | | 3.54" X 76.77" X 3.74" / 18.90" X 18.90" X 1.97" |
| | | | | 18.11" X 25.98" X 0.83" / 6.30" X 16.54" X 1.22" |

| POSTER POCKET | | | WEIGHT | PACKING SIZE(10 Pcs) |
|---------------|------------|-------------|--------------|--------------------------|
| ARTICLE | PAPER SIZE | DESCRIPTION | WITH PACKING | *W X H X D |
| TAB0590104 | 8.5" X 11" | Red | 1.212 lbs | 15.35" X 21.65" X 23.23" |
| TAB0590101 | 8.5" X 11" | Black | 1.212 lbs | 15.35" X 21.65" X 23.23" |
| TAB0590109 | 8.5" X 11" | Grey | 1.212 lbs | 15.35" X 21.65" X 23.23" |

* W:Width H: Height D: Depth





Floor Standing Reference Rack



Steel stand with PET pockets, Table Top Reference allows you to organize busy environments. Pole constructed heavy aluminium extrusion. Each pocket displays 2 brochures. Pockets flip easily. Do not forget to order pockets separately. Holds 10 pockets at a time allowing to display 20 pages.

 Holds 10 pockets at a time. Packed unassembled.

 Sturdy base for a stable and secure unit.

 Pockets should be ordered separately. Pockets available in Red, Black and Grey.

 3 packs. See info chart for pack sizes.

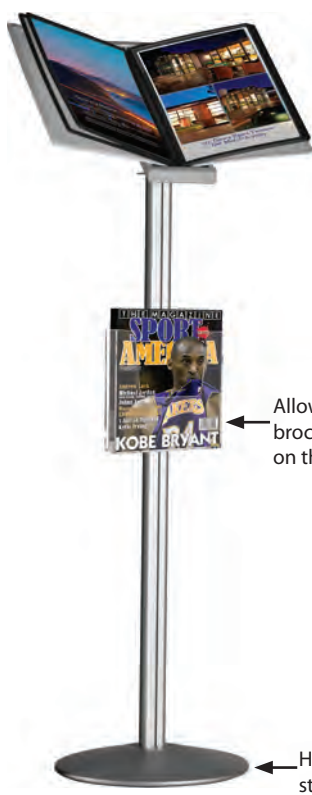

Allows extra brochure holder on the pole

Base powder coated RAL 9006, 7.605 lbs.

Heavy sturdy base



Please don't forget to order pockets.

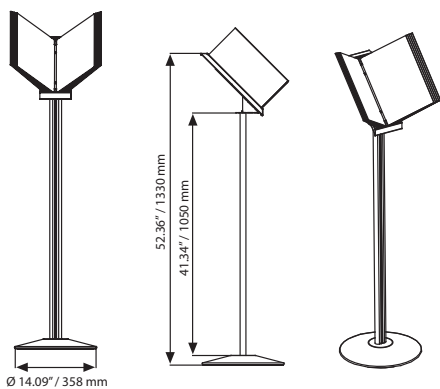

| MATERIAL : Silver anodised aluminium | | | WEIGHT | PACKING SIZE |
|--------------------------------------|------------|-------------|--------------|--|
| ARTICLE | PAPER SIZE | DESCRIPTION | WITH PACKING | *W X H X D |
| URK05N0081 | 8.5" X 11" | Silver Rack | 20.282 lbs | 2.76" X 44.09" X 1.57" / 14.96" X 15.35" X 1.97" |
| | | | | 6.30" X 16.54" X 4.33" |
| URK05B0081 | 8.5" X 11" | Black Rack | 20.282 lbs | 2.76" X 44.09" X 1.57" / 14.96" X 15.35" X 1.97" |
| | | | | 6.30" X 16.54" X 4.33" |

| POSTER POCKET | | | WEIGHT | PACKING SIZE (10 Pcs) |
|---------------|------------|-------------|--------------|--------------------------|
| ARTICLE | PAPER SIZE | DESCRIPTION | WITH PACKING | *W X H X D |
| TAB0590104 | 8.5" X 11" | Red | 1.212 lbs | 15.35" X 21.65" X 23.23" |
| TAB0590101 | 8.5" X 11" | Black | 1.212 lbs | 15.35" X 21.65" X 23.23" |
| TAB0590109 | 8.5" X 11" | Grey | 1.212 lbs | 15.35" X 21.65" X 23.23" |

* W:Width H: Height D: Depth



Adjustable Flipchart & Reversible Flipchart



Made of Steel and aluminium, single sided Adjustable Flipchart has whiteboard surface which is both magnetic and drywipe. Important messages, tables, charts can be clipped with magnets. Alternatively large papers can be clipped or drywipe surface can be written for more interactive meetings or presentations. Foldable pen tray stores the pens, eraser or some other accessories. Height is easily adjusted to max 1850mm. Powder coated tripod legs provide stability to Adjustable Flipchart. Soft corners and rubber feet allow using in schools as well any commercial or office environments.

 A magnetic eraser and 3 magnets are supplied in the pack.

 Drawing pads and pen not included. Protective film over magnetic surface should be removed before use.

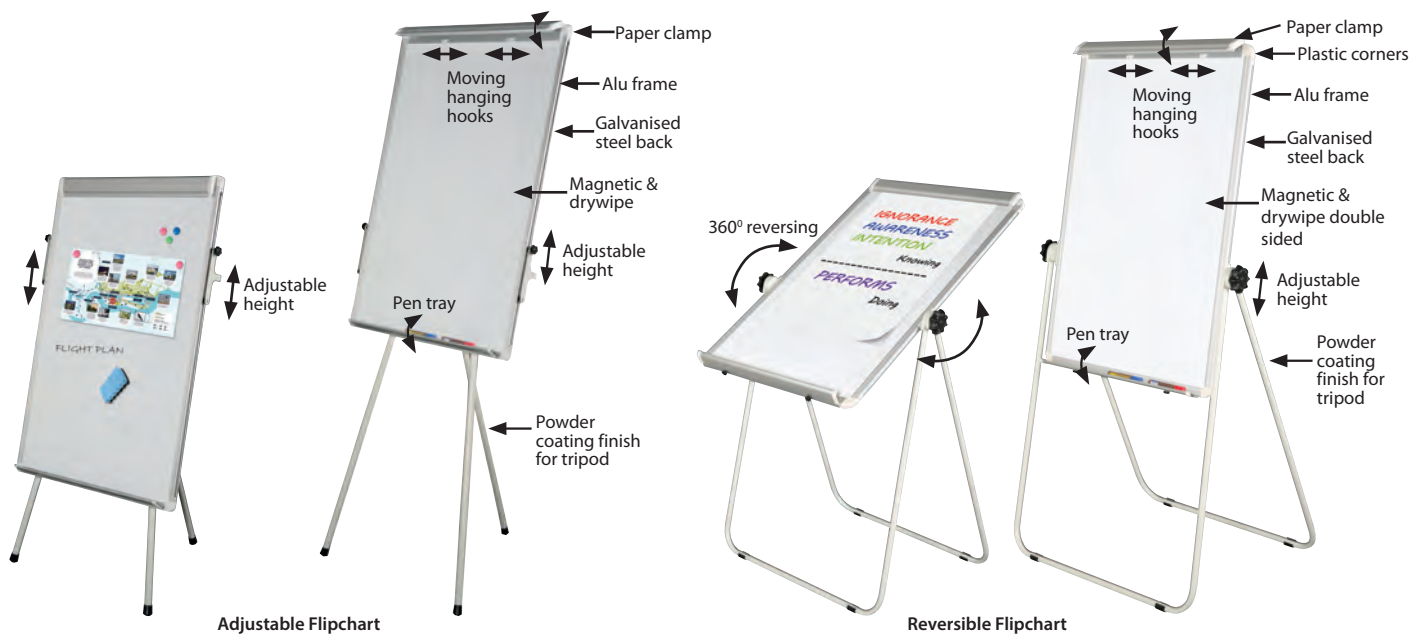

Adjustable Flipchart

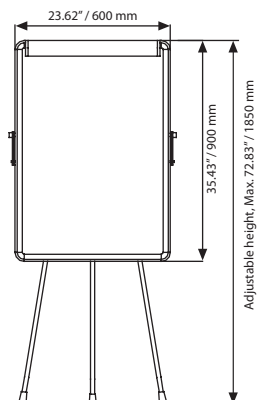

Reversible Flipchart

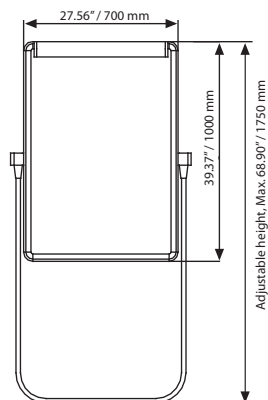

Magnetic buttons included.



Magnetic Eraser included.

| MATERIAL: Steel & aluminium | | | | | WEIGHT | PACKING SIZE |
|-----------------------------|-----------------|-----------------|--------|----------------------|--------------|-------------------------|
| ARTICLE | BOARD SIZE | WRITABLE AREA | COLOUR | DESCRIPTION | WITH PACKING | *W X H X D |
| TWYFC33301 | 23.62" X 35.43" | 21.26" X 31.69" | White | Adjustable Flipchart | 15.873 lbs | 26.57" X 42.91" X 2.95" |
| TWYFC66601 | 27.56" X 39.37" | 25.20" X 35.63" | White | Reversible Flipchart | 21.384 lbs | 32.48" X 45.08" X 2.95" |

*W:Width H: Height D: Depth



Modern Easel



See movie at our website www.mtdisplays.com.tr



Made of Beechwood, Easel is a solid product for commercial use. Adjustable easel accommodates varying canvas sizes. It is made to be sturdy, strong, and will last in retail settings. Adjustable back support ensures stability of the easel and comfortable use at different angles. It folds flat for easy storage.



It holds frames from B2 up to A0.



Please order the accessories separately.

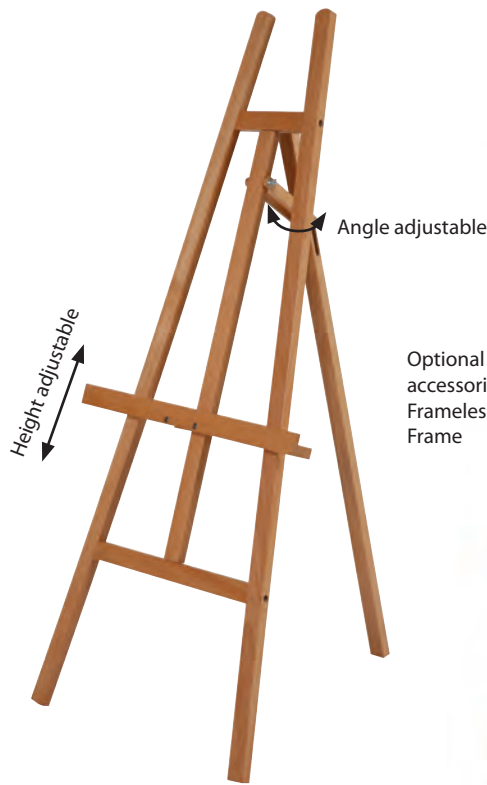

Optional accessories
Frameless
Frame



Optional Accessories

- Opti Frame see page 17-18
- Snap Frame see page 24
- Magetic Glassboard see page 179
- Easy Wood Frame see page 134
- Frameless Frame see pag 134
- Frameboard 9 mm see page 178

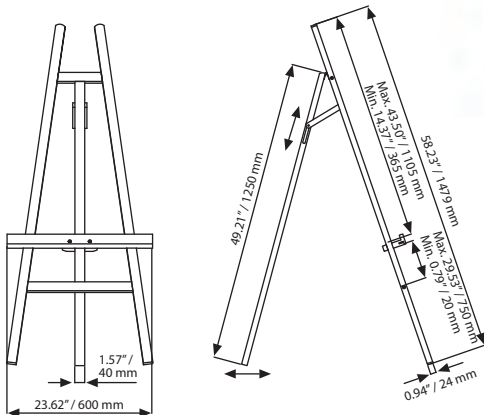

Don't forget to order
Chalkboard Marker
UYAKLM1251 - Colour Marker
UYAKLM1250 - White Marker

| MATERIAL: Beech Wood | | WEIGHT | PACKING SIZE |
|----------------------|--------------------------|--------------|------------------------|
| ARTICLE | SIZE | WITH PACKING | *W X H X D |
| USLM000015 | 23.62" X 31.10" X 58.27" | 11.023 lbs | 4.53" X 60.24" X 2.95" |

*W:Width H: Height D: Depth



Art Easel

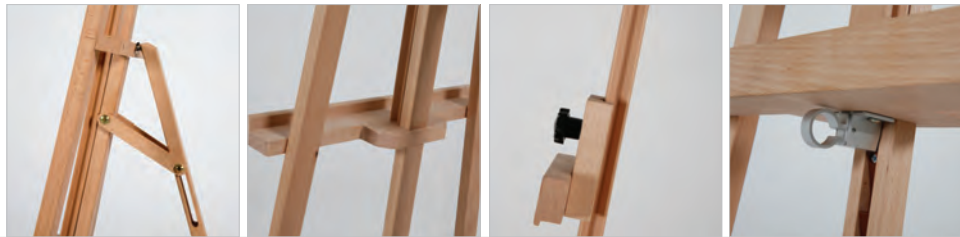

Made of Beechwood, Easel is a solid product for commercial use. Adjustable easel accommodates varying canvas sizes. It is made to be sturdy, strong, and will last in retail settings. Adjustable back support ensures stability of the easel and comfortable use at different angles. It folds flat for easy storage.



It holds frames from B2 up to A0.



Please order the accessories separately.

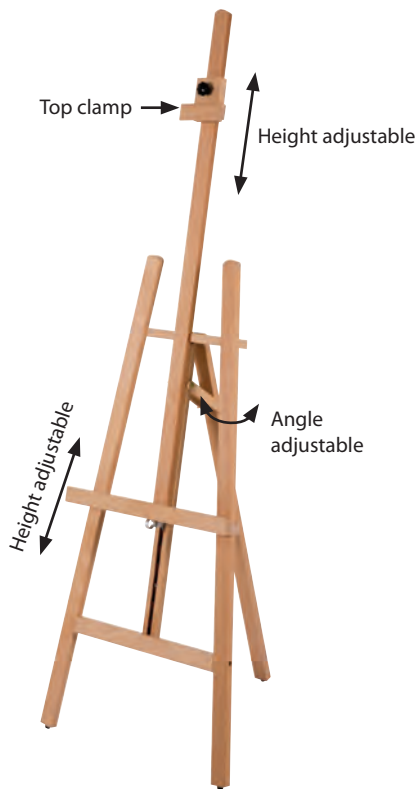

Optional accessories
Magnetic
Glassboard

Optional Accessories

- Opti Frame see page 17-18
- Snap Frame see page 24
- Magnetic Glassboard see page 179
- Easy Wood Frame see page 134
- Frameless Frame see page 134
- Frameboard 9 mm see page 178

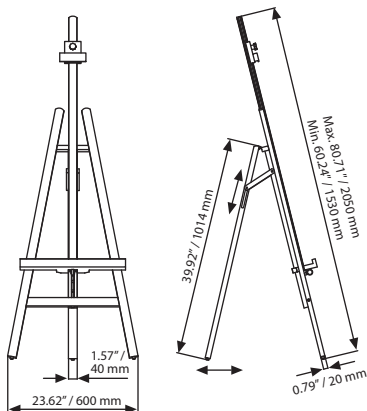

Don't forget to order
Chalkboard Marker
UYAKLM1251 - Colour Marker
UYAKLM1250 - White Marker

| MATERIAL: Beech Wood | | WEIGHT | PACKING SIZE |
|----------------------|--------------------------|--------------|------------------------|
| ARTICLE | SIZE | WITH PACKING | *W X H X D |
| USLA000012 | 23.62" X 21.65" X 60.24" | 12.125 lbs | 5.31" X 48.82" X 3.35" |

*W:Width H: Height D: Depth



Basic Easel



See movie at our website www.mtdisplays.com.tr



Basic Easel is made of Pine wood which is one of the most strongest woods used for furniture. Basic Easel is an economic solution for many types of business. Height adjustable easel accommodates varying canvas sizes. It is made to be sturdy, strong, and will last in retail settings. Adjustable back support and chain ensures stability of the easel and comfortable use at different angles. It folds flat for easy storage.



It holds frames from B2 up to A0.



Please order the accessories separately.



Assembly in 10 seconds.



Optional accessories
Snap Frame

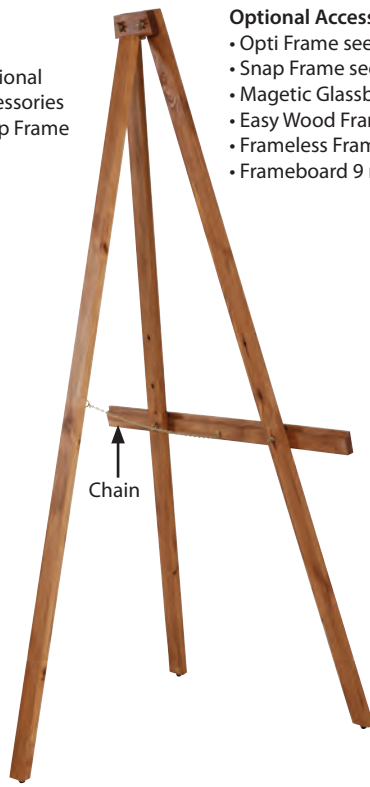

Chain

Optional Accessories

- Opti Frame see page 17-18
- Snap Frame see page 24
- Magnetic Glassboard see page 179
- Easy Wood Frame see page 134
- Frameless Frame see page 134
- Frameboard 9 mm see page 178

3 different display height

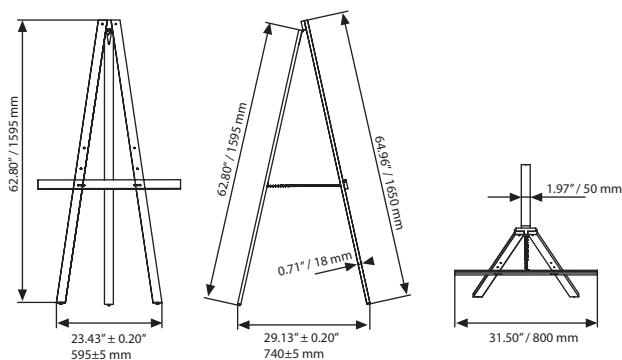
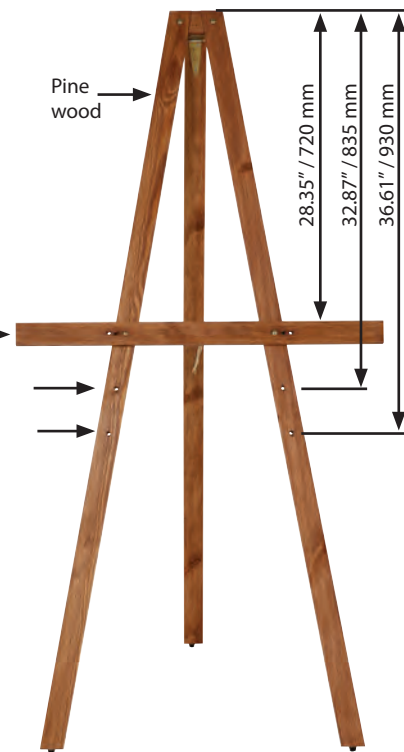

Don't forget to order
Chalkboard Marker
UYAKLM1251 - Colour Marker
UYAKLM1250 - White Marker

| MATERIAL : Pine wood | | | WEIGHT | PACKING SIZE |
|----------------------|-----------------|--------------|--------------|------------------------|
| ARTICLE | SIZE (x-y) | DESCRIPTION | WITH PACKING | *W X H X D |
| USLBN00016 | 23.43" X 29.13" | Natural Wood | 11.023 lbs | 6.10" X 67.72" X 3.15" |
| USLBD00016 | 23.43" X 29.13" | Dark Wood | 11.023 lbs | 6.10" X 67.72" X 3.15" |

*W:Width H: Height D: Depth



Portable Easel



See movie at our website www.mtdisplays.com.tr



Portable Easel is made of aluminium and steel, it is durable and suitable for various environments. Textured black finish gives smart look for Portable Easel. 5 different positions allow displaying various sizes of frames. Foldable feet helps transporting and storing. Simply spread the two legs apart, and the unit is ready for use. Suitable for restaurants, boutiques, art galleries, classrooms or more.

It holds frames from 22"x28" up to 36"x48"

No tool assembly.

Packed unassembled with an easy to understand instructions.

Color options : Silver-anodized & black

Optional Accessories

- Opti Frame see page
- Snap Frame see page
- Magnetic Glassboard see page
- Easy Wood Frame see page
- Frameless Frame see page
- Frameboard 9 mm see page



Mobile peg

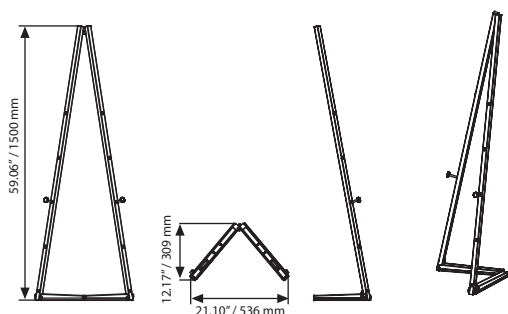

| MATERIAL: Steel | | | WEIGHT | PACKING SIZE |
|-----------------|--------------------------|-------------|--------------|------------------------|
| ARTICLE | SIZE | DESCRIPTION | WITH PACKING | *W X H X D |
| UPESLOG015 | 59.06" X 21.10" X 12.17" | Gray | 10.031 lbs | 3.94" X 61.81" X 1.97" |
| UPESLOB015 | 59.06" X 21.10" X 12.17" | Black | 10.031 lbs | 3.94" X 61.81" X 1.97" |



*W:Width H: Height D: Depth

Rotatable Model White Boards

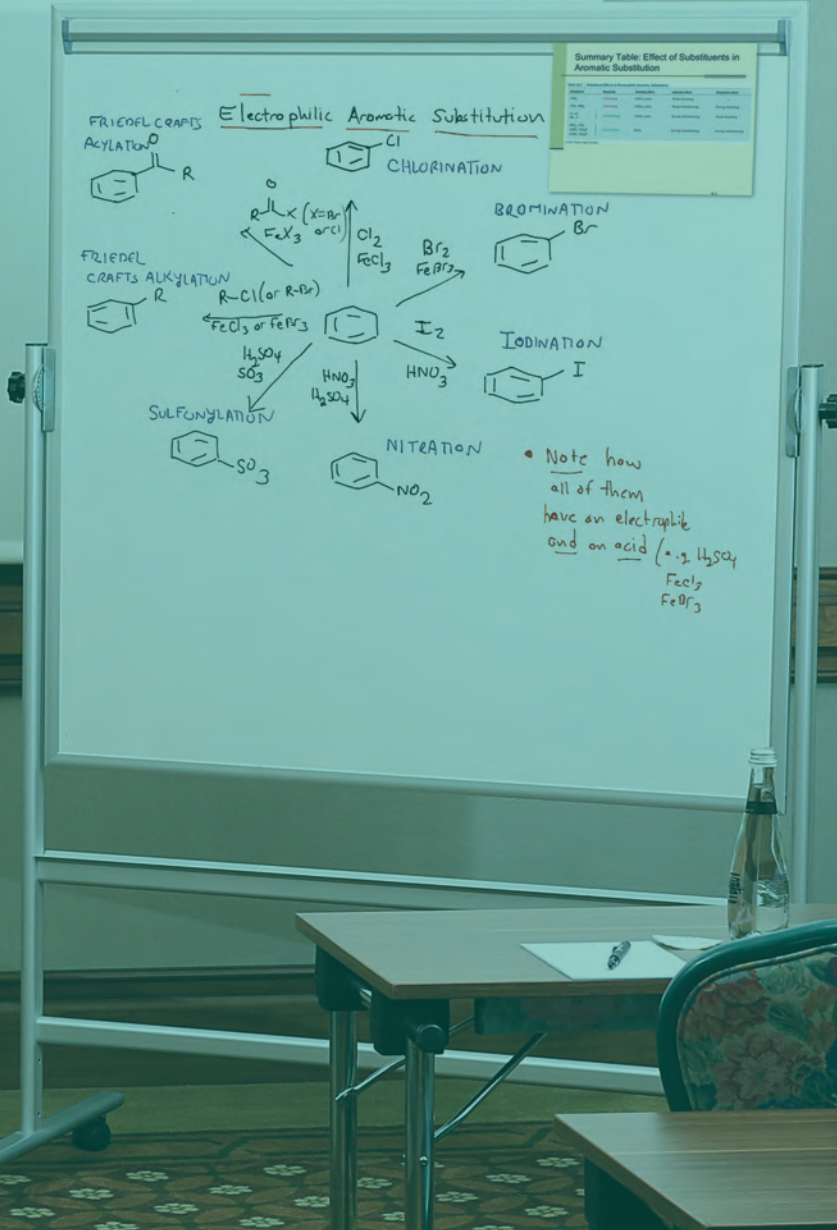

Summary Table: Effect of Substituents in Aromatic Substitution

| Substituent | Directing Effect | Relative Reactivity |
|-----------------------------------|------------------|---------------------|
| -H | - | 1 |
| -CH ₃ | ortho/para | >1 |
| -R | ortho/para | >1 |
| -OCH ₃ | ortho/para | >>1 |
| -OH | ortho/para | >>1 |
| -NH ₂ | ortho/para | >>1 |
| -C(CH ₃) ₃ | ortho/para | >1 |
| -Cl | ortho/para | <1 |
| -Br | ortho/para | <1 |
| -I | ortho/para | <1 |
| -SO ₂ CH ₃ | meta | <1 |
| -NO ₂ | meta | <<1 |
| -CO ₂ CH ₃ | meta | <<1 |
| -CHO | meta | <<1 |
| -COR | meta | <<1 |



Tablet & TV Stands

- Slim TV Stand
- Counter Tablet Holders
 - Semi Circle Tablet Holder
 - Gray Tripod Tablet Holder
 - Hook Tablet Holder
 - Pocket Tablet Holder
 - Peek Tablet Holder
 - Moon Tablet Holder
 - Turret Tablet Holder
 - Pyramid Tablet Holder
 - Universal Desktop Tablet Kiosk
- Tablet Kiosk
 - Universal Curved Tablet Kiosk
 - Universal Flexible Tablet Kiosk
 - Universal Novel Tablet Kiosk
 - Universal Novel Tablet Kiosk for Wall & Freestanding
- Boomerang Floor Tablet Stand
- Spider Floor Tablet Stand
- Red Spider Floor Tablet Stand



Slim TV Stand





Slim TV stand is a portable stand which is easy to move room-to-room for any reason. It is designed to hold flat-screen monitors between 30" and 50" that weigh less than 156lbs. The VESA-compatible bracket fits most brand names and models

Slim TV stand with wheels includes a 15.75 inch-wide shelf that can be positioned at 3 different levels along the floor-standing fixture for presentation accessories. The stand itself is also height adjustable, with 8 set heights at which a monitor may be positioned. This black rolling TV stand is equipped with locking wheels for easy movement.

It provides comfortable use by adjusting the screen height and angle. Suitable to use in all places where space is limited.

 Suitable for screens 30" up to 50" and can carry up to 132lbs/59kg.

 Castored wheels.

 Easy mounting sheets enclosed.

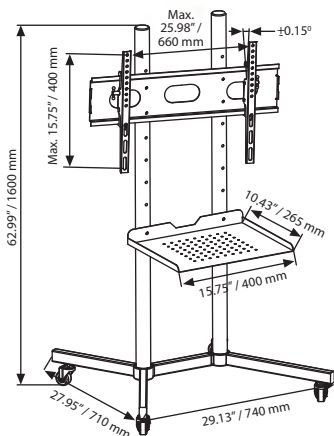

| MATERIAL : Black anodised aluminium | | WEIGHT | PACKING SIZE |
|-------------------------------------|-------------|--------------|---------------------------------------|
| ARTICLE | DESCRIPTION | WITH PACKING | *W X H X D |
| UTVS10B000 | Black | 14,000 kg | 430 X 730 X 65 mm - 120 X 147 X 65 mm |



*W:Width H: Height D: Depth

Tablet Holders

Wide selection of tablet holders is suitable for most tablets, smart phones and laptops both in landscape and portrait positions. They designed for ergonomic use, adjustable and with soft edges to protect furniture from scratches.



Semi Circle Tablet Holder



Color options :
Silver-anodized & black.

| MATERIAL : ABS Plastic | | WEIGHT | PACKING SIZE |
|------------------------|-------------|--------------|------------------------|
| ARTICLE | DESCRIPTION | WITH PACKING | *W X H X D |
| TGRIA30301 | Black | 0.992 lbs | 8.27" X 11.81" X 1.38" |
| TGRIA30309 | Silver | 0.992 lbs | 8.27" X 11.81" X 1.38" |



*W:Width H: Height D: Depth

Gray Tripod Tablet Holder

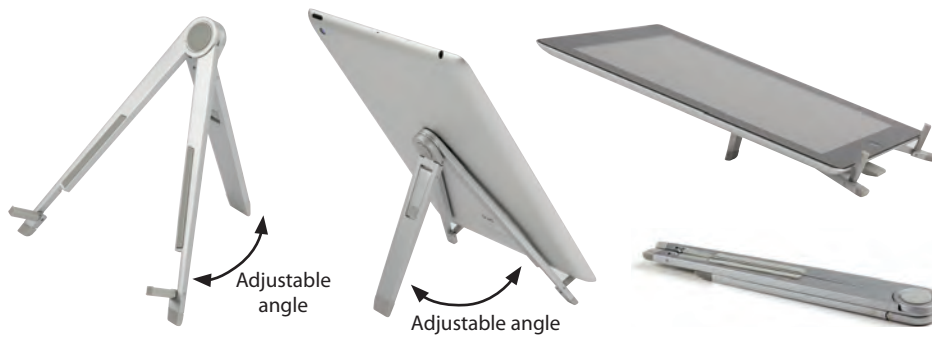

| MATERIAL : | | WEIGHT | PACKING SIZE |
|------------|-------------|--------------|-----------------------|
| ARTICLE | DESCRIPTION | WITH PACKING | *W X H X D |
| TLCPO22009 | Silver | 1.781 lbs | 9.84" X 9.06" X 5.71" |



*W:Width H: Height D: Depth

Hook Tablet Holder

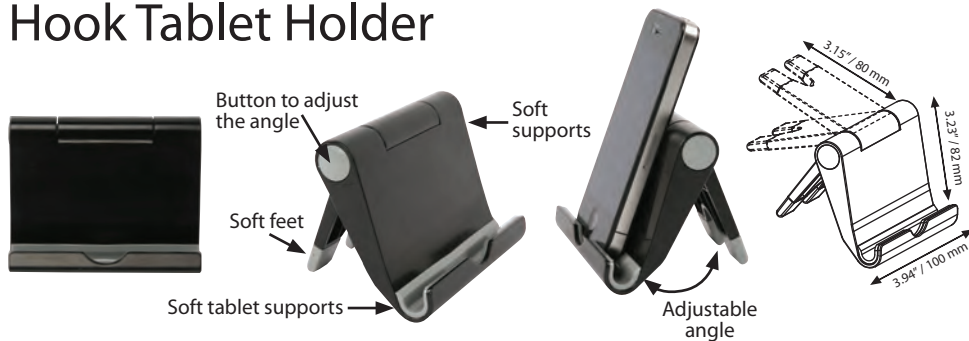

| MATERIAL : ABS Plastic | | WEIGHT | PACKING SIZE |
|------------------------|-------------|--------------|-----------------------|
| ARTICLE | DESCRIPTION | WITH PACKING | *W X H X D |
| TGRID10201 | Black | 0.242 lbs | 3.54" X 4.33" X 1.38" |



*W:Width H: Height D: Depth

Pocket Tablet Holder



| MATERIAL : ABS & Aluminium | | WEIGHT | PACKING SIZE |
|----------------------------|-------------|--------------|-----------------------|
| ARTICLE | DESCRIPTION | WITH PACKING | *W X H X D |
| TGRID10301 | Black | 0.496 lbs | 5.51" X 8.27" X 1.77" |



*W:Width H: Height D: Depth

Peak Tablet Holder

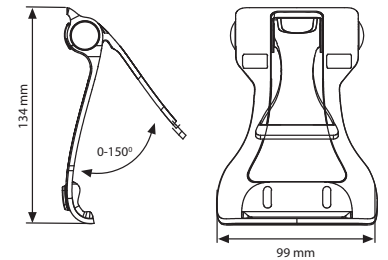

| MATERIAL : ABS Plastic | | WEIGHT | PACKING SIZE |
|------------------------|-------------|--------------|-----------------------|
| ARTICLE | DESCRIPTION | WITH PACKING | *W X H X D |
| TLCP036003 | White-Pink | 0.665 lbs | 4.13" X 5.71" X 1.18" |
| TLCP037009 | Silver | 1.091 lbs | 4.13" X 5.71" X 1.18" |

*W:Width H:Height D:Depth

TP 2 YEAR WARRANTY

Moon Tablet Holder

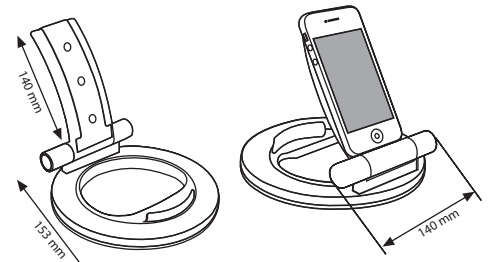

| MATERIAL : ABS PLASTIC | | WEIGHT | PACKING SIZE |
|------------------------|-------------|--------------|-----------------------|
| ARTICLE | DESCRIPTION | WITH PACKING | *W X H X D |
| TGRID10403 | WHITE | 0.524 lbs | 6.69" X 6.69" X 1.97" |

*W:Width H:Height D:Depth

TP 2 YEAR WARRANTY

Turret Tablet Holder

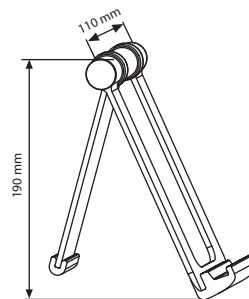

| MATERIAL : ABS Plastic | | WEIGHT | PACKING SIZE |
|------------------------|-------------|--------------|-----------------------|
| ARTICLE | DESCRIPTION | WITH PACKING | *W X H X D |
| TLCP008009 | Silver | 0.661 lbs | 5.71" X 9.06" X 1.77" |

*W:Width H:Height D:Depth

TP 2 YEAR WARRANTY

Pyramid Tablet Holder

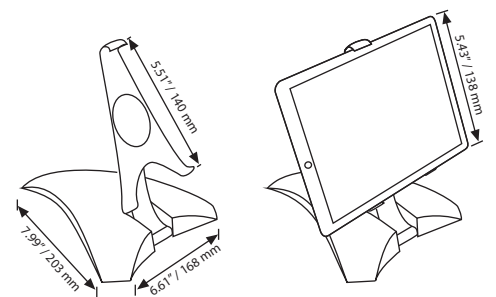

| MATERIAL : ABS Plastic | | WEIGHT | PACKING SIZE |
|------------------------|-------------|--------------|-----------------------|
| ARTICLE | DESCRIPTION | WITH PACKING | *W X H X D |
| TFRIA30303 | White | 1.091 lbs | 7.87" X 9.84" X 2.36" |

*W:Width H:Height D:Depth

TP 2 YEAR WARRANTY



Universal Desktop Tablet Kiosk



See movie at our website www.mtdisplays.com.tr



Smart Solutions for Technological Devices! Desktop universal tablet stand offers smart solutions for introductions or presentations in offices or commercial environments. It is suitable for iPad1, 2, 3, 4, Air, Samsung Galaxy and most 9.7"-10.1" tablets. The tablet holder can be rotated to display landscape portrait positions and tablet is secured with a lockable case to reduce the risk of theft. The home button is covered to prevent interfering from the public. It is already inclined at a convenient fixed reading angle.

-  Packed assembled.
-  USB cable is not included. Order separately. Fixing for floor mounting included.
-  Closed home button.

One product, two positions (landscape & portrait)

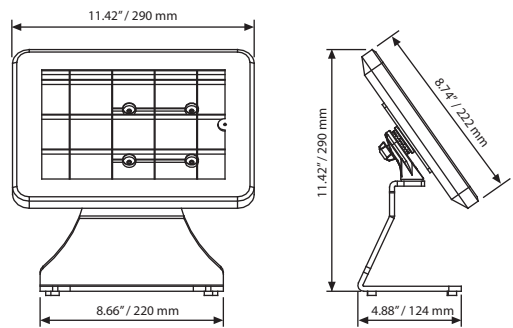

| MATERIAL : Steel & acrylic | | WEIGHT | PACKING SIZE |
|----------------------------|-------------|--------------|------------------------|
| ARTICLE | DESCRIPTION | WITH PACKING | *W X H X D |
| UUTMOB1B00 | Black | 2.755 lbs | 12.80" X 9.45" X 5.12" |



*W:Width H: Height D: Depth



Universal Curved Tablet Kiosk



See movie at our website www.mtdisplays.com.tr



Smart Solutions for Technological Devices! With sleek design and matt finish, Universal Curved Tablet Kiosk captures customers' attention in all traffic areas. Universal Curved Tablet Kiosk is suitable for iPad1, 2, 3, 4, Air, Samsung Galaxy and most 9.7"-10.1" tablets. The tablet holder can be rotated to display landscape portrait positions and tablet is secured with a lockable case to reduce the risk of theft. The home button is covered to prevent interfering from the public. Universal Curved iPad Kiosk is suitable for retail purposes, trade shows and conventions as well as car galleries, furniture stores when the base is adjusted. It has a complete style with black cover and cable travelling through the pole.

-  Packed unassembled with an easy to understand instruction for assembly.
-  USB cable is not included. Order separately. Fixing for floor mounting included.
-  Closed home button.



Don't forget to order USB cable.

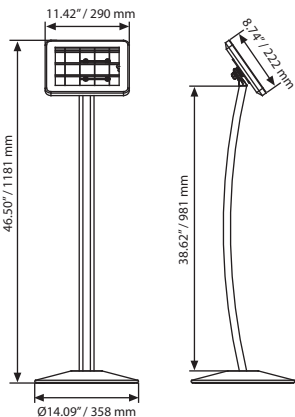

TZZZ998701
Cable lock kit for iPad 82.68"



TSTDCI450B
Cable for all iPhones & iPads.



TSTDCIP40B
Cable for iPhone 4S, iPad 3 and earlier.



TSTDCIP50B
Cable for iPhone 5, iPad 4 and later.



TSTDCV80B
Cable V8, micro USB for Samsung, LG etc...



UYPPD0000
Lightning to 30-pin adapter. Packed by 10 pcs. You can use all type of Kiosk for iPad 4 too.

| MATERIAL : Black anodised aluminium | | WEIGHT | PACKING SIZE |
|-------------------------------------|-------------|--------------|-------------------------|
| ARTICLE | DESCRIPTION | WITH PACKING | *W X H X D |
| UUTC0B1B00 | Black | 10.758 lbs | 18.50" X 43.70" X 2.64" |

*W:Width H:Height D:Depth



Universal Flexible Tablet Kiosk



See movie at our website www.mtdisplays.com.tr



It is a genuine design for today's technological display solutions. The tablet holder can be rotated to display landscape portrait positions and adjusted to at a required reading angle. The height of the kiosk can be adjusted to max 1220mm. when landscape and max 1245mm when portrait. Universal Flexible Tablet Kiosk is suitable for iPad1, 2, 3, 4, Air, Samsung Galaxy and most 9.7"-10.1" tablets. The tablet holder can be rotated to display landscape portrait positions and tablet is secured with a lockable case to reduce the risk of theft. The home button is covered to prevent interfering from the public. Universal Curved iPad Kiosk is suitable for retail purposes, trade shows and conventions as well as car galleries, furniture stores when the base is adjusted.

- Packed unassembled with an easy to understand instruction for assembly.
- USB cable is not included. Order separately. Fixing for floor mounting included.
- Closed home button.

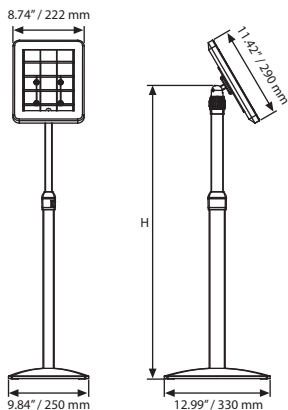
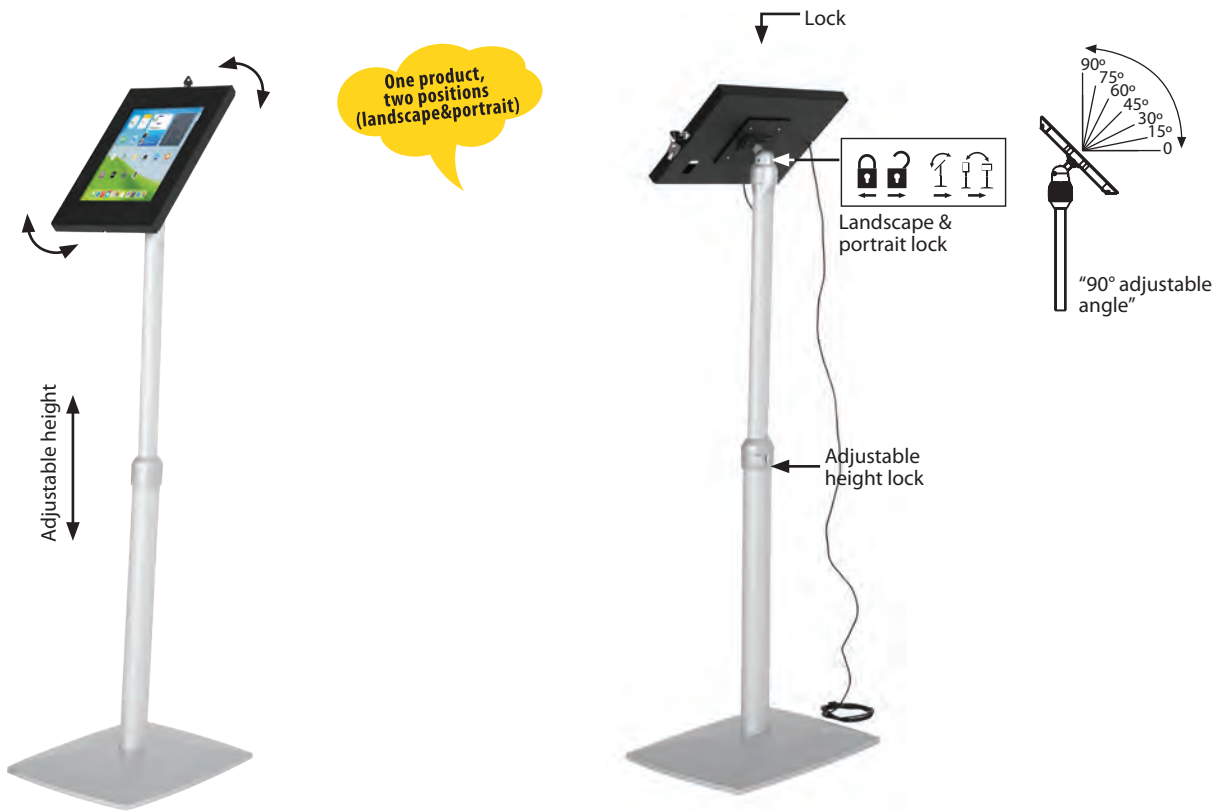

Don't forget to order USB cable.



TZZZ998701
Cable lock kit for iPad 82.68"



TSTDCI450B
Cable for all iPhones & iPads.



TSTDCIP40B
Cable for iPhone 4S, iPad 3 and earlier.



TSTDCIP50B
Cable for iPhone 5, iPad 4 and later.



TSTDCV80B
Cable V8, micro USB for Samsung, LG etc...



UYPPD0000
Lightning to 30-pin adapter. Packed by 10 pcs. You can use all type of Kiosk for iPad 4 too.

| MATERIAL : Silver anodised aluminium | | | WEIGHT | PACKING SIZE |
|--------------------------------------|-------------|-------------|--------------|-------------------------|
| ARTICLE | Height Max. | Height Min. | WITH PACKING | *W X H X D |
| UUTFON0B00 | 43.11" | 30.91" | 11.243 lbs | 11.22" X 41.73" X 4.21" |

*W:Width H: Height D: Depth



Universal Novel Tablet Kiosk



See movie at our website www.mtdisplays.com.tr



Smart Solutions for Technological Devices! Universal Novel Tablet Kiosk is suitable for iPad1, 2, 3, 4, Air, Samsung Galaxy and most 9.7"-10.1" tablets. The tablet holder can be rotated to display landscape portrait positions and tablet is secured with a lockable case to reduce the risk of theft. USB cable travels through the pole for cleaner view. The home button is covered to prevent interfering from the public. Universal Novel iPad Kiosk is suitable for retail purposes, trade shows and conventions as well as car galleries, furniture stores when the base is adjusted.

- Packed unassembled with an easy to understand instruction for assembly.
- USB cable is not included. Order separately. Fixing for floor mounting included.
- Closed home button.

One product, two positions (landscape & portrait)

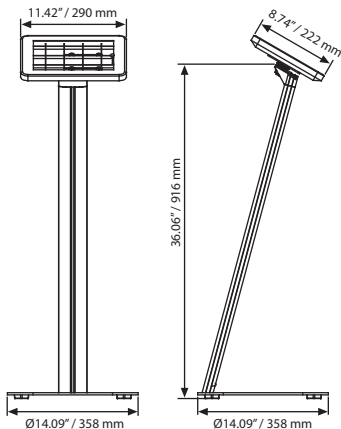

Don't forget to order USB cable.



TZZZ998701
Cable lock kit for iPad 82.68"



TSTDCI450B
Cable for all iPhones & iPads.



TSTDCIP40B
Cable for iPhone 4S, iPad 3 and earlier.



TSTDCIP50B
Cable for iPhone 5, iPad 4 and later.



TSTDCV80B
Cable V8, micro USB for Samsung, LG etc...



UYPPD0000
Lightning to 30-pin adapter. Packed by 10 pcs. You can use all type of Kiosk for iPad 4 too.

| MATERIAL : Silver anodised aluminium | | WEIGHT | PACKING SIZE |
|--------------------------------------|-------------|--------------|-------------------------|
| ARTICLE | DESCRIPTION | WITH PACKING | *W X H X D |
| UUTNON1B00 | Silver | 13.889 lbs | 14.96" X 42.52" X 4.21" |

*W:Width H: Height D: Depth



Universal Novel Tablet Kiosk for Wall & Freestanding



See movie at our website www.mtdisplays.com.tr



Smart Solutions for Technological Devices! Universal Novel Kiosk for wall or freestanding is suitable for iPad1, 2, 3, 4, Air, Samsung Galaxy and most 9.7"-10.1" tablets. The tablet holder can be rotated to display landscape portrait positions and tablet is secured with a lockable case to reduce the risk of theft. USB cable travels through the pole for cleaner view. The home button is covered to prevent interfering from the public. Universal Novel Kiosk is suitable for retail purposes, trade shows and conventions as well as car galleries, furniture stores. It is easily mounted on required height.

-  Packed unassembled with an easy to understand instruction for assembly.
-  USB cable is not included. Order separately. Fixing for floor mounting included.
-  Closed home button.

 Color options : Silver-anodized & black.



TZZZ998701
Cable lock kit for iPad 82.68"



UYPPD0000
Lightning to 30-pin adapter. Packed by 10 pcs. You can use all type of Kiosk for iPad 4 too.

For Wall

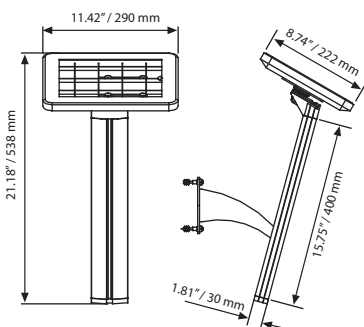

For Freestanding

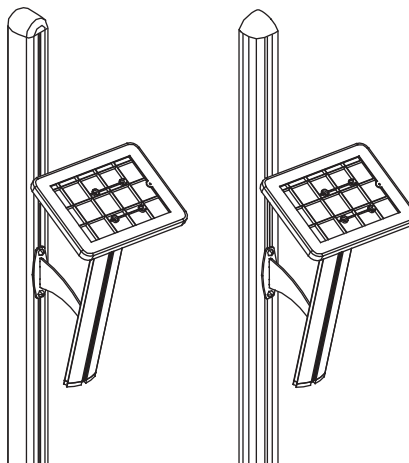

| MATERIAL : Silver anodised aluminium | | WEIGHT | PACKING SIZE |
|--------------------------------------|--------------------------|--------------|-------------------------|
| ARTICLE | DESCRIPTION | WITH PACKING | *W X H X D |
| UUTWON1B00 | for Wall / White | 4.960 lbs | 12.20" X 18.90" X 8.27" |
| UUTWOB1B00 | for Wall / Black | 4.960 lbs | 12.20" X 18.90" X 8.27" |
| UUTNFB1B00 | for Freestanding / White | 4.960 lbs | 12.20" X 18.90" X 8.27" |
| UUTNFB1B00 | for Freestanding / Black | 4.960 lbs | 12.20" X 18.90" X 8.27" |



*W:Width H: Height D: Depth



Boomerang Floor Tablet Stand



With heavy wide feet, this Floor Standing stand suitable for iPad, iPad 2, iPad 3, Samsung 10.1" and any tablet from 9.7" to 10.1". Height adjustable from 4.53" to 5.28". It can be easily adjusted for comfortable view angle adjusting the angle 90 degrees.

-  Packed unassembled with an easy to understand instruction for assembly.
-  USB cable is not included. Order separately.
-  Suitable for both landscape and portrait use.

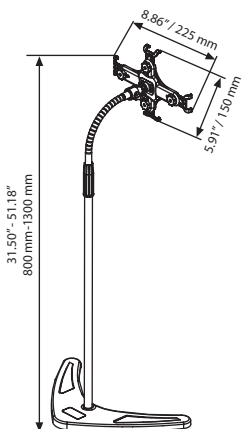

Don't forget to order USB cable.



TSTDCI450B
Cable for
iPhone 4&5.



TSTDICIP40B
Cable for
iPhone 4.



TSTDCIP50B
Cable for
iPhone 5.



TSTDCV80B
Cable V8 for
Samsung.



TZZZ998701
Cable lock kit for
iPad 82.68"

| MATERIAL : ABS Plastic & Steel Stable Flat Base | | WEIGHT | PACKING SIZE |
|---|-------------|--------------|-------------------------|
| ARTICLE | DESCRIPTION | WITH PACKING | *W X H X D |
| TGRIF40101 | Black | 10.288 lbs | 11.42" X 30.71" X 3.66" |



*W:Width H: Height D: Depth



Spider Floor Tablet Stand



This table stand is suitable for 9,5"-10,6" tablets. Height is adjustable so that convenient to use in sitting position. It is easy to adjust the angle of tablet holder for comfortable eye level. V shape base provides stability to the stand.

-  Packed unassembled with an easy to understand instruction for assembly.
-  USB cable is not included. Order separately.
-  Suitable for both landscape and portrait use.



One product, two positions (landscape & portrait)

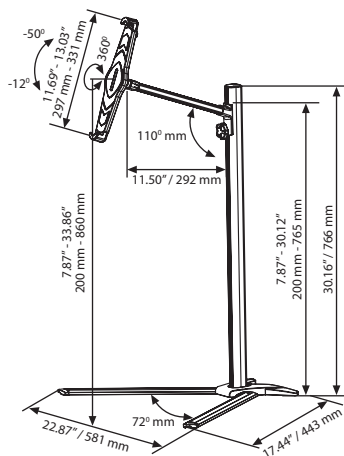

Don't forget to order USB cable.



TSTDCI450B
Cable for iPhone 4&5.



TSTDCIP40B
Cable for iPhone 4.



TSTDCIP50B
Cable for iPhone 5.



TSTDCV80B
Cable V8 for Samsung.



TZZZ998701
Cable lock kit for iPad 82.68"

| MATERIAL : ABS & Aluminium | | WEIGHT | PACKING SIZE |
|----------------------------|-------------|--------------|-------------------------|
| ARTICLE | DESCRIPTION | WITH PACKING | *W X H X D |
| TLCP707009 | Silver | | 12.20" X 32.28" X 3.66" |



*W:Width H: Height D: Depth



Red Spider Floor Tablet Stand



360 degree rotatable tablet stand suitable for iPad 2, iPad 3 and iPad 4. It allows portrait and landscape viewing. Height is adjustable for comfortable eye view while sitting.

-  Packed unassembled with an easy to understand instruction for assembly.
-  USB cable is not included. Order separately.
-  Suitable for both landscape and portrait use.

 Color options : Silver-anodized & black.

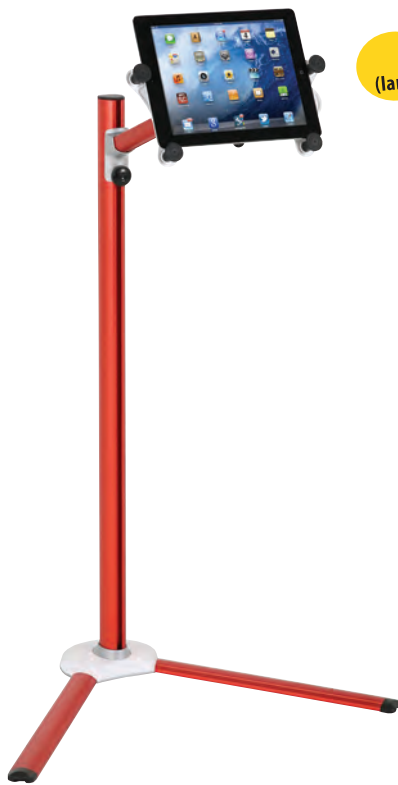

One product, two positions (landscape & portrait)



Can be locked by the button



Height adjustable

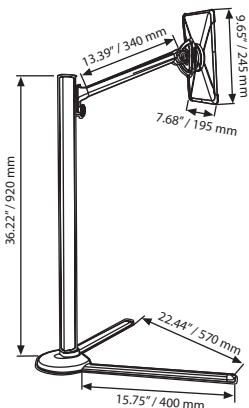

Don't forget to order USB cable.



TSTDCI450B
Cable for iPhone 4&5.



TSTDCIP40B
Cable for iPhone 4.



TSTDCIP50B
Cable for iPhone 5.



TSTDCV80B
Cable V8 for Samsung.



TZZZ998701
Cable lock kit for iPad 82.68\"/>

| MATERIAL : ABS & Aluminium | | WEIGHT | PACKING SIZE |
|----------------------------|-------------|--------------|------------------------|
| ARTICLE | DESCRIPTION | WITH PACKING | *W X H X D |
| TGRIF80604 | Red | 6.393 lbs | 9.84" X 37.01" X 3.15" |

*W:Width H:Height D:Depth



Universal Flexible Tablet Kiosk





Brochure Holders & Leaflet Displays



- Photo Frame
- Cross Frame
- Leaflet Dispensers
- Multiple Pocket Leaflet Dispensers
- Wall Mount Leaflet Dispensers
- Clear Brochure Holder T Type
- Clear Brochure Holder T Type
- L Type with front Pocket
- Swing Wing
- Pet Pocket
- Foldable Leaflet Holder
- Upright Leaflet Holder
- Oval Leaflet Holder
- Duo Desktop Menu Holder
- Fort Desktop Menu Holder
- Curved Desktop Menu Holder
- Ticket Holder
- Card Holder 2 Sided
- Pyramid Card Holder
- Arc Menu Holder

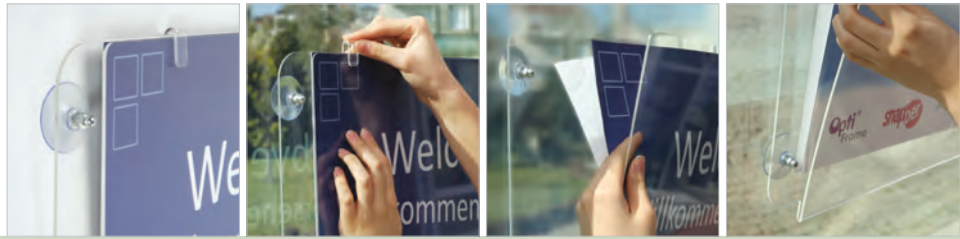

Clear Frame



Clear window Frame is made of 0.12" acrylic and displays the poster as double sided. There are four strong suction cups to hold the sign for displaying the poster on glass doors or windows. The printed posters are easily inserted from top and sides, and remain mounted while changing them. These clear window frames are suitable to use at shop window, store entrances, restaurants etc.

-  Please clean the surface before applying the suction cup for better application. 4 suction cups included in the pack.
-  In large formats, 2 clear clips are included.
-  Please handle with care during transportation. Peel of the film over the product before use.

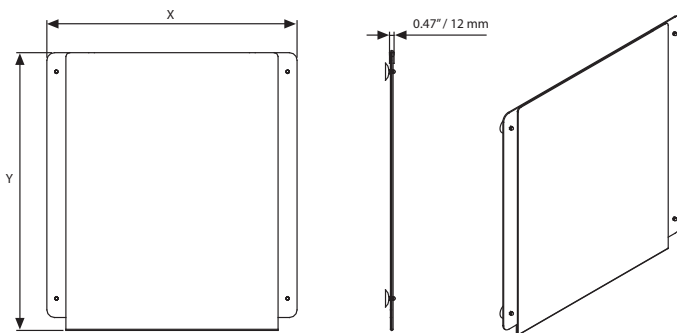

| MATERIAL : Clear acrylic 0.12" | | | | WEIGHT | PACKING SIZE |
|--------------------------------|-----------------|-------------|-------------|--------------|-------------------------|
| ARTICLE | EXTERNAL (x-y) | POSTER SIZE | DESCRIPTION | WITH PACKING | *W X H X D |
| UCF00Y0081 | 14.92" X 9.21" | 8.5" X 11" | Landscape | 1.477 lbs | 9.06" X 16.54" X 1.22" |
| UCF00D0081 | 12.40" X 11.73" | 8.5" X 11" | Portrait | 1.543 lbs | 11.42" X 13.78" X 1.22" |
| UCF00D0022 | 25.91" X 28.74" | 22" X 28" | Portrait | 7.738 lbs | 27.56" X 28.74" X 1.22" |
| UCF00D0017 | 14.92" X 17.72" | 11" X 17" | Portrait | 2.854 lbs | 16.14" X 17.72" X 1.22" |
| UCF00D0011 | 14.92" X 14.2" | 11" X 14" | Portrait | 2.314 lbs | 14.57" X 16.14" X 1.22" |



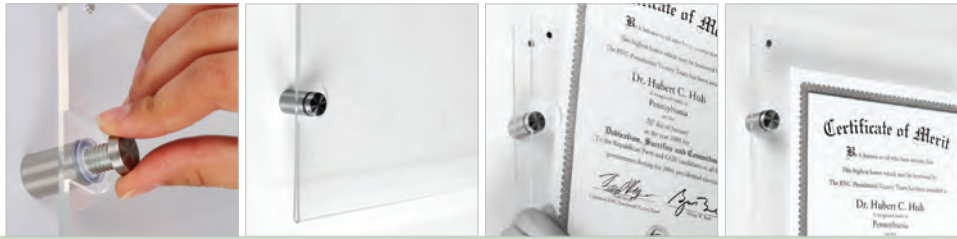

*W:Width H: Height D: Depth

Wall Mount Clear Acrylic Frame with Standoff Hardware and Magnets



Designed as frameless, Standoff Mount Acrylic Sign is a practical display system allowing to change poster when it is still on the wall by sliding. It is suitable for environments where the advertisement or promotions are changed very often such as offices, meeting rooms, travel agents, hotels, restaurants and many more. Standoff Mount Acrylic Sign is also suitable for branding.

 Peel off the film.

 Handle with care during transportation. Peel of the film over the product before use.

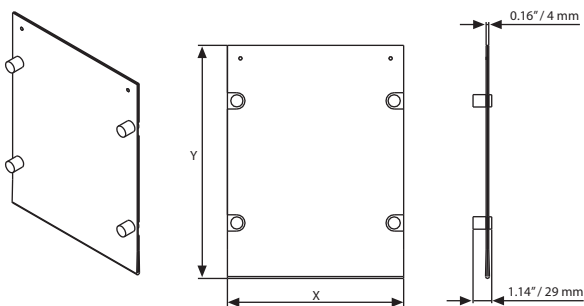

Fixing kit included.

| MATERIAL : Clear acrylic 0.08" | | | WEIGHT | PACKING SIZE |
|--------------------------------|-----------------|-------------|--------------|-------------------------|
| ARTICLE | EXTERNAL (x-y) | POSTER SIZE | WITH PACKING | *W X H X D |
| USMSOD0081 | 10.87" X 13.37" | 8.5" X 11" | 1.234 lbs | 11.81" X 18.11" X 1.77" |
| USMSOD0017 | 13.37" X 19.36" | 11" X 17" | 2.028 lbs | 14.96" X 23.23" X 1.77" |
| USMSOD0018 | 20.36" X 26.36" | 18" X 24" | 4.409 lbs | 21.26" X 27.56" X 1.57" |
| USMSOD0022 | 24.36" X 30.36" | 22" X 28" | 6.172 lbs | 25.20" X 31.89" X 1.57" |

*W:Width H:Height D:Depth



Table Top Clear Acrylic Frame



Contemporary poster or photo holder, Tabletop Clear Frame is suitable for both personal and commercial use. Transparent thick acrylic gets attention to the poster. Portrait or landscape adaptable decorative stands provide a smart finish for Tabletop L Frame.

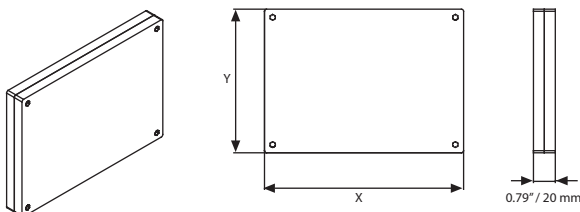
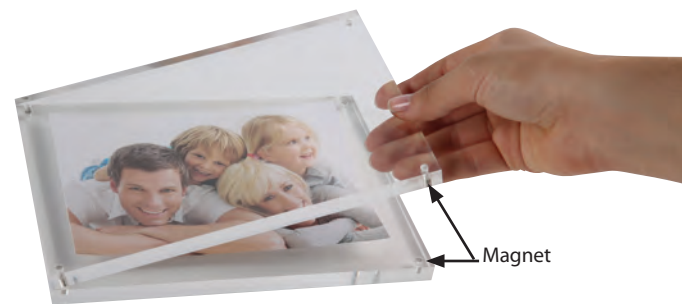
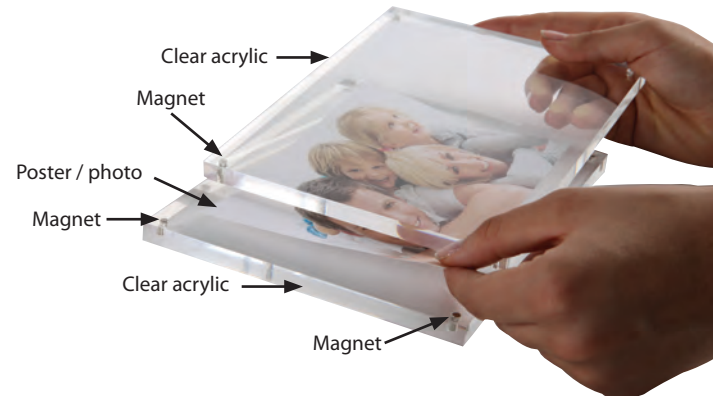

| MATERIAL : Clear acrylic 0.39" | | | WEIGHT | PACKING SIZE |
|--------------------------------|----------------|-------------|--------------|-----------------------|
| ARTICLE | EXTERNAL (x-y) | POSTER SIZE | WITH PACKING | *W X H X D |
| UMSTTCF046 | 7.18" X 5.18" | 4" X 6" | 1.366 lbs | 6.30" X 8.66" X 4.92" |
| UMSTTCF057 | 8.18" X 6.18" | 5" X 7" | 1.851 lbs | 7.09" X 9.45" X 4.92" |



*W:Width H: Height D: Depth

Acrylic Photo Frame



Bended from 0.08" clear acrylic, Photo Frame serves various needs of both trade and even personal needs. Suitable to use for all kind of messages, menu lists as well as pictures. Pop-out feet is stable on the counter. Rounded corners provides elegant look to Photo Frame.

! Please handle with care during transportation. Please peel of the film over the product before use.



8.5" X 11" Size



5" X 7" Size

Slide-in photo →



Clear acrylic →

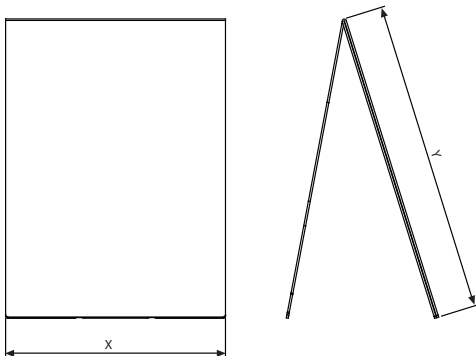
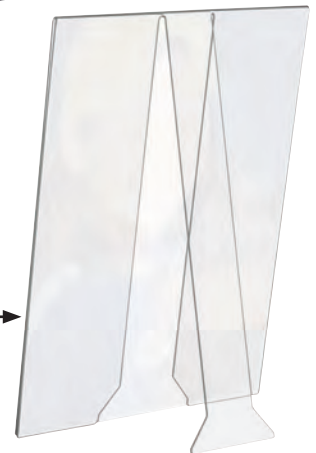

| MATERIAL : Clear acrylic 0.08" | | | WEIGHT | PACKING SIZE |
|--------------------------------|----------------|-------------|--------------|-------------------------|
| ARTICLE | EXTERNAL (x-y) | POSTER SIZE | WITH PACKING | *W X H X D |
| UMSPHT0046 | 4" X 6.12" | 4" X 6" | 0.242 lbs | 7.87" X 15.75" X 5.51" |
| UMSPHT0058 | 5.5" X 8.62" | 5.5" X 8.5" | 0.418 lbs | 11.02" X 15.75" X 7.48" |
| UMSPHT0057 | 5" X 7.12" | 5" X 7" | 0.330 lbs | 9.06" X 15.75" X 6.69" |
| UMSPHT0081 | 8.5" X 11.12" | 8.5" X 11" | 0.837 lbs | 15.75" X 14.17" X 9.84" |
| UMSPHT0010 | 8" X 10.12" | 8" X 10" | 0.771 lbs | 12.20" X 15.75" X 9.45" |

*W:Width H: Height D: Depth



Cross Frame



Clear sing holder, Cross Frame allows advertising many messages accepting 8 posters a time. Flat packed Cross Frame saves from space. Rounded corners provides elegant look to Cross Frame. Made of 0.08" clear acrylic.

! Please handle with care during transportation.
Please peel of the film over the product before use.



4 X (5.5" X 8.5") Size



4 X (4" X 6") Size



Bottom part



Top part

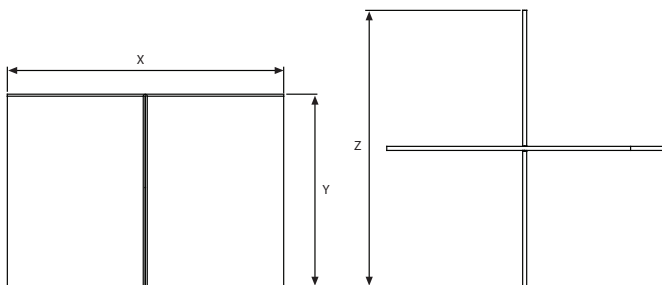

| MATERIAL : Clear acrylic 0.08" | | | | | | WEIGHT | PACKING SIZE |
|--------------------------------|-------------|-----------------|--------|-------|--------|--------------|-------------------------|
| ARTICLE | POSTER SIZE | CAPACITY | X | Y | Z | WITH PACKING | *W X H X D |
| UMSCR00446 | 4"X6" | 4 X (4"X6") | 8.23" | 6.10" | 8.23" | 0.771 lbs | 10.24" X 11.42" X 7.09" |
| UMSCR00458 | 5.5"X8.5" | 4 X (5.5"X8.5") | 11.22" | 8.58" | 11.22" | 1.477 lbs | 5.91" X 13.39" X 9.84" |
| UMSCR00457 | 5"X7" | 4 X (5"X7") | 10.20" | 7.09" | 10.20" | 0.992 lbs | 11.42" X 12.20" X 8.27" |

*W:Width H: Height D: Depth



Counter Top Brochure Holders



Highly resistant transparent document holders. Format 8.5"x11" is suitable for the display of all types of documents such as catalogues, brochures, cards for every need, etc... These high quality injection molded leaflet dispensers can be screen printed with logo on your request. Now it is ready with a unit divider for 8.5"x11" portrait into 4"x6" size.

Silk Screen Printing on Leaflet Dispensers

Minimum Pad Printing quantity is 200 pcs. Please note the printing operations may extend the lead times. During each printing operation, a visual image of logo is requested as a Illustrator file. The maximum printing area on the dispenser is as follows.

! Please handle with care during transportation.



"Colour options RED GREEN YELLOW BLUE. Available with MOQ"

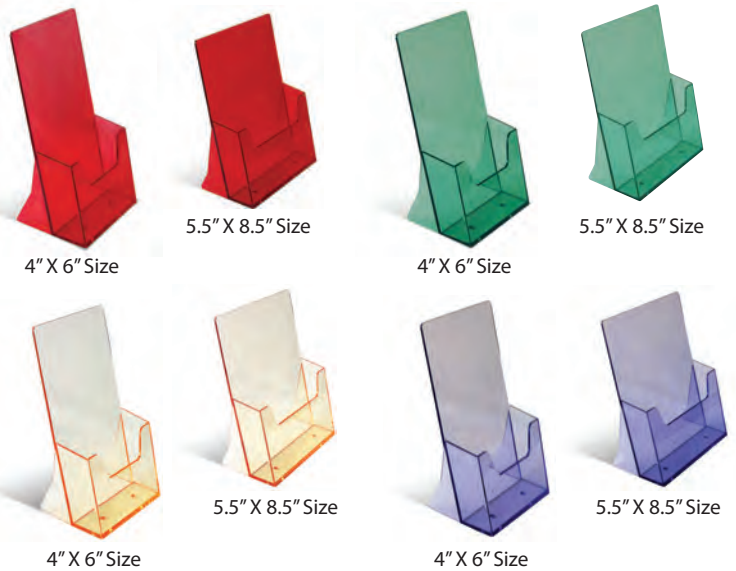

4" X 6" Size

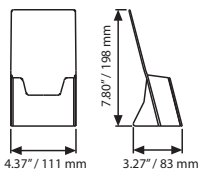

5.5" X 8.5" Size

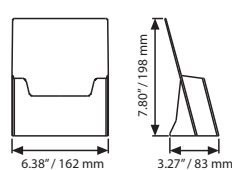

| MATERIAL : Clear | | |
|------------------|---------------|-------------|
| SIZE | PRINTING SIZE | DESCRIPTION |
| 4" X 6" | 1.57" X 3.54" | Portrait |
| 5.5" X 8.5" | 2.17" X 5.51" | Portrait |

| MATERIAL : Clear | | | WEIGHT | PACKING SIZE |
|------------------|---------------|----------------------|--------------|----------------------------------|
| ARTICLE | POSTER | DESCRIPTION | WITH PACKING | *W X H X D |
| UMSD001004 | 5.83" X 8.27" | 5.5" X 8.5" Portrait | 19.488 lbs | 20.47" X 24.80" X 9.84" (40 pcs) |
| UMSD001003 | 3.94" X 8.27" | 4" X 6" Portrait | 16.093 lbs | 18.90" X 25.20" X 8.27" (50 Pcs) |

* W:Width H: Height D: Depth



Multiple Pocket Brochure Holders

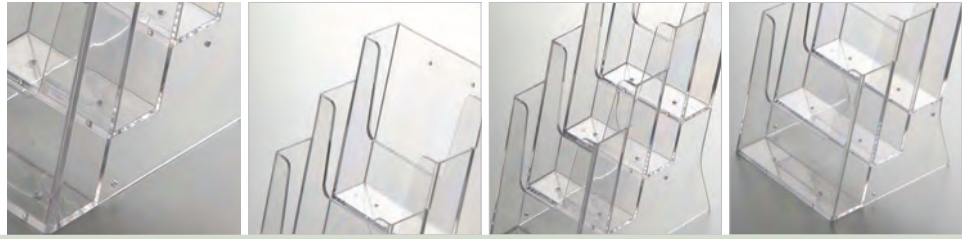

Highly resistant transparent document holders. Dispensers can be screen printed with corporate logo. Our products are made of the finest materials while providing the highest level of quality and clarity.

! Please handle with care during transportation.



3 X (5.5" X 8.5") Portrait



3 X (4" X 6") Portrait



4 X (4" X 6") Portrait

3 X (4" X 6") Portrait

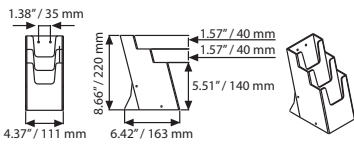

3 X (5.5" X 8.5) Portrait

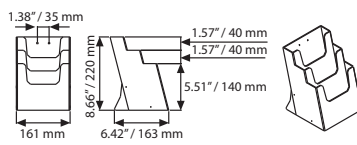

4 X (4" X 6") Portrait

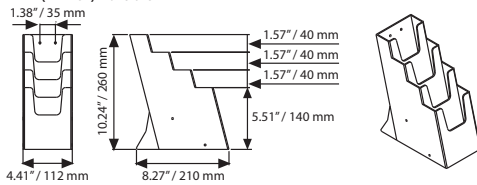

| MATERIAL : Clear | | WEIGHT | PACKING SIZE |
|------------------|---------------|--------------|-----------------------------------|
| ARTICLE | POSTER | WITH PACKING | *W X H X D |
| UMSD003050 | 3.94" X 8.27" | 17.085 lbs | 14.96" X 27.56" X 14.17" (18 pcs) |
| UMSD004000 | 5.83" X 8.27" | 13.845 lbs | 14.96" X 22.05" X 13.78" (12 pcs) |
| UMSD005000 | 3.94" X 8.27" | 18.959 lbs | 14.96" X 32.68" X 9.84" (20 pcs) |

*W:Width H: Height D: Depth



Wall Mount Brochure Holders



Highly resistant transparent document holders. They can be mounted in any convenient location. They come in 4 sizes and the clear pocket is ideal for the display of menus, price lists, etc.. These high quality brochure holders can be screen printed. All models are in stock and ready for immediate shipment.

Silk Screen Printing on Wall Mount Leaflet Dispensers

The minimum pad printing quantity is 200 pcs. Please note the printing operations may extend the lead time. In each printing operation, a visual image of the logo is requested as a Illustrator file. The maximum printing area on the wall mount dispensers is as follows.

! Please handle with care during transportation.



8.5" X 11" Size



5.5" X 8.5" Size



4" X 6" Size



2 X (4" X 6") Size

4" X 6" Size

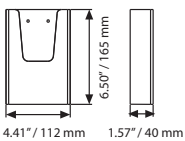

4.41" / 112 mm 1.57" / 40 mm

2 X (4" X 6") Size

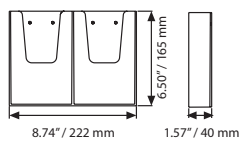

8.74" / 222 mm 1.57" / 40 mm

8.5" X 11" Size

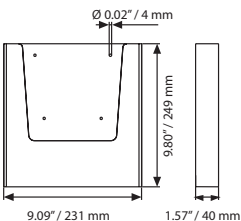

9.09" / 231 mm 1.57" / 40 mm

5.5" X 8.5" Size

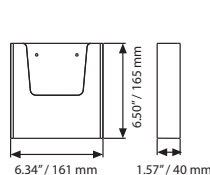

6.34" / 161 mm 1.57" / 40 mm

| MATERIAL : Clear | | |
|------------------|---------------|-------------|
| SIZE | PRINTING SIZE | DESCRIPTION |
| 4" X 6" | 2.36" X 3.54" | Portrait |
| 5.5" X 8.5" | 2.36" X 5.51" | Portrait |
| 8.5" X 11" | 2.36" X 7.87" | Portrait |

| MATERIAL : Clear | | | WEIGHT | PACKING SIZE |
|------------------|---------------|------------------------|--------------|----------------------------------|
| ARTICLE | POSTER | DESCRIPTION | WITH PACKING | *W X H X D |
| UMSD008100 | 8.5" X 11" | 8.5" X 11" Portrait | 28.439 lbs | 20.47" X 24.80" X 9.84" (30 Pcs) |
| UMSD007000 | 5.5" X 8.5" | 5.5" X 8.5" Portrait | 20.502 lbs | 21.26" X 25.20" X 7.48" (45 pcs) |
| UMSD006000 | 4" X 6" | 4" X 6" Portrait | 20.392 lbs | 18.90" X 25.20" X 8.27" (60 Pcs) |
| UMSD006010 | 2 X (4" X 6") | 2 X (4" X 6") Portrait | 22.046 lbs | 18.90" X 25.20" X 8.27" (30 Pcs) |

* W:Width H: Height D: Depth



Clear Brochure Holder T Type

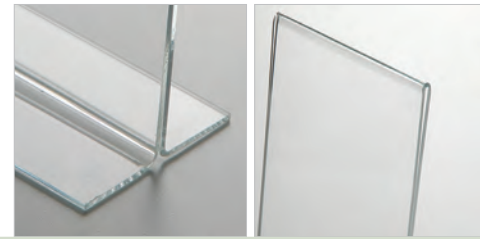

Highly resistant transparent document holders. Ideal for the display of menus at restaurants, price lists, etc... These high quality clear brochure holders can be screen printed with corporate logo. Non-standard sizes can be produced according to customer specification & needs; for printing and quantities, please contact our sales department.

! Please handle with care during transportation. Please peel of the film over the product before use.



8.5" X 11" Portrait



4" X 6" Portrait



5" X 7" Portrait



5" X 7" Landscape

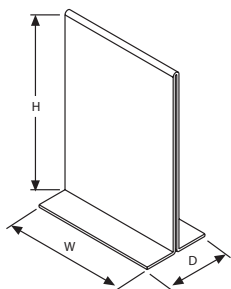

| MATERIAL : Clear | | | | | | WEIGHT | PACKING SIZE |
|------------------|------------|----------------------|------|--------|-------|--------------|----------------------------------|
| ARTICLE | POSTER | DESCRIPTION | W | H | D | WITH PACKING | *W X H X D |
| UMSTD05000 | 8.5" X 11" | 8.5" X 11" Portrait | 8.5" | 11.22" | 4.13" | 32.848 lbs | 18.50" X 26.38" X 9.65" (40 pcs) |
| UMSTY05000 | 8.5" X 11" | 8.5" X 11" Landscape | 11" | 8.70" | 4.13" | 24.250 lbs | 26.77" X 18.11" X 9.65" (30 pcs) |
| UMSTD09000 | 5" X 7" | 5" X 7" Portrait | 5" | 7.20" | 2.95" | 12.698 lbs | 13.78" X 17.72" X 7.09" (30 pcs) |
| UMSTY09000 | 5" X 7" | 5" X 7" Landscape | 7" | 5.20" | 2.95" | 12.698 lbs | 12.99" X 13.78" X 9.65" (30 pcs) |
| UMSTD08000 | 4" X 6" | 4" X 6" Portrait | 4" | 6.21" | 4.13" | 10.802 lbs | 16.93" X 20.08" X 5.51" (40 pcs) |
| UMSTY08000 | 4" X 6" | 4" X 6" Landscape | 6" | 4.21" | 4.13" | 15.432 lbs | 13.78" X 16.14" X 9.25" (30 pcs) |

*W:Width H: Height D: Depth



Clear Brochure Holder L Type & with Front Pocket



The highly resistant transparent document holders are ideal for the display of menus at restaurants, price lists, etc... These high quality clear brochure holders can be screen printed with a corporate logo. Non-standard sizes can be produced according to customer specification & needs; for printing and quantities, please contact our sales department.

advantage of the product is the pocket in front of the brochure holder, so that any poster, menu, advertising info can be put in. The advantageous pocket enables you to place your business card on the poster. This product can be produced in different sizes on request. Highly resistant transparent document holders. These high quality clear brochure holders can be screen printed with a corporate logo.

! Please handle with care during transportation. Please peel of the film over the product before use.

Our new range of sign holders offers competitive solutions to effect a maximum outcome for your sales and marketing activities. The main



8.5" X 11" Portrait



4" X 6" Portrait



5" X 7" Portrait



8.5" X 11" with Front Pocket Portrait



5" X 7" Landscape

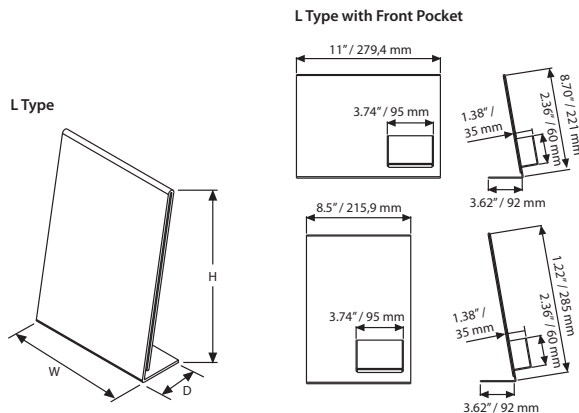

| L TYPE WITH FRONT POCKET: Clear | | | WEIGHT | PACKING SIZE |
|---------------------------------|------------|----------------------|--------------|---------------------------------|
| ARTICLE | POSTER | DESCRIPTION | WITH PACKING | *W X H X D |
| UMSLDC1000 | 8.5" X 11" | 8.5" X 11" Portrait | 9.369 lbs | 9.45" X 13.78" X 1.34" (10 pcs) |
| UMSLYC1000 | 11" X 8.5" | 8.5" X 11" Landscape | 9.810 lbs | 9.45" X 13.78" X 1.34" (10 pcs) |

| MATERIAL : Clear | | | | | | WEIGHT | PACKING SIZE |
|------------------|------------|----------------------|------|--------|-------|--------------|----------------------------------|
| ARTICLE | POSTER | DESCRIPTION | W | H | D | WITH PACKING | *W X H X D |
| UMSLD06000 | 8.5" X 11" | 8.5" X 11" Portrait | 8.5" | 11.22" | 3.62" | 25,353 lbs | 13.39" X 14.57" X 9.45" (40 pcs) |
| UMSLY06000 | 8.5" X 11" | 8.5" X 11" Landscape | 11" | 8.70" | 3.62" | 22,046 lbs | 13.39" X 14.57" X 9.45" (30 pcs) |
| UMSLD01057 | 5" X 7" | 5" X 7" Portrait | 5" | 7.20" | 2.83" | 12,698 lbs | 12.60" X 13.78" X 9.45" (30 pcs) |
| UMSLY01057 | 5" X 7" | 5" X 7" Landscape | 7" | 5.20" | 2.83" | 12,698 lbs | 12.60" X 13.78" X 9.45" (30 pcs) |
| UMSLD09000 | 4" X 6" | 4" X 6" Portrait | 4" | 6.21" | 2.83" | 9,259 lbs | 13.39" X 15.35" X 9.45" (40 pcs) |
| UMSLY09000 | 4" X 6" | 4" X 6" Landscape | 6" | 4.21" | 2.83" | 15,432 lbs | 13.39" X 15.35" X 9.45" (50 pcs) |

*W:Width H: Height D: Depth



Swing Wing

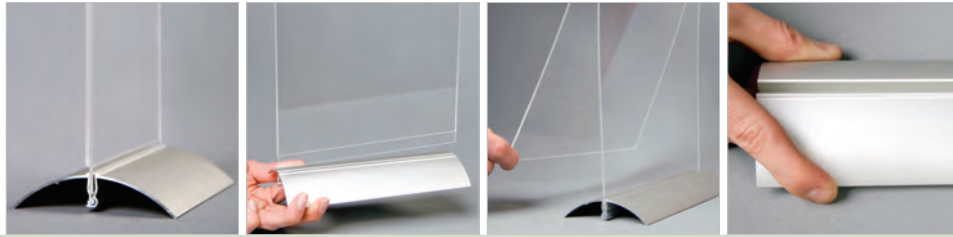

Classy menu holder with a clear acrylic pocket and stylish silver-anodized aluminum base. Acrylic pockets fits securely into aluminium base. Ideal for the display of menus. Non-standard sizes can be produced according to customer needs. The aluminum base is suitable for logo printing. Max letter height in printing is 1.57". Several poster materials can be used with this base; PVC Foam, PS, PET. The thickness varies between 0.04" - 0.16".

! Please handle with care during transportation. Please peel off the film over the product before use.



← Catch thickness
min. 0.04"
max. 0.16"

8.5" X 11" Portrait



4" X 6" Portrait



5" X 7" Portrait



5" X 7" Landscape

| MATERIAL : Silver anodised aluminium | | | WEIGHT | PACKING SIZE |
|--------------------------------------|--------|----------------|--------------|---------------------------------|
| ARTICLE | POSTER | DESCRIPTION | WITH PACKING | *W X H X D |
| USWMDNP004 | 4" | Aluminium base | 1.058 lbs | 5.12" X 7.87" X 4.33" (12 pcs) |
| USWMDNP005 | 5" | Aluminium base | 1.984 lbs | 5.91" X 7.09" X 4.72" (12 pcs) |
| USWMDNP006 | 6" | Aluminium base | 2.513 lbs | 6.69" X 07.09" X 4.72" (12 pcs) |
| USWMDNP007 | 7" | Aluminium base | 2.645 lbs | 6.69" X 7.09" X 4.72" (12 pcs) |
| USWMDNP085 | 8.5" | Aluminium base | 3.306lbs | 7.09" X 9.06" X 4.72" (12 pcs) |
| USWMDNP011 | 11" | Aluminium base | 4.100 lbs | 7.09" X 11.81" X 4.72" (12 pcs) |

| MATERIAL : Silver anodised aluminium & clear acrylic | | | WEIGHT | PACKING SIZE |
|--|-------------|-------------------------------------|--------------|---------------------------------|
| ARTICLE | POSTER | DESCRIPTION | WITH PACKING | *W X H X D |
| USWMDNP046 | 4" X 6" | Aluminium base & Acrylic - Portrait | 8.686 lbs | 9.65" X 13.78" X 3.39" (30 pcs) |
| USWMDNP057 | 5" X 7" | Aluminium base & Acrylic - Portrait | 4.894 lbs | 9.84" X 13.78" X 3.54" (10 pcs) |
| USWMDNP058 | 5.5" X 8.5" | Aluminium base & Acrylic - Portrait | 13.227 lbs | 9.65" X 13.78" X 3.39" (25 pcs) |
| USWMDNP081 | 8.5" X 11" | Aluminium base & Acrylic - Portrait | 13.933 lbs | 9.65" X 13.78" X 3.39" (15 pcs) |

| ARTICLE | POSTER | DESCRIPTION | WITH PACKING | *W X H X D |
|------------|-------------|--------------------------------------|--------------|---------------------------------|
| USWMDNP046 | 4" X 6" | Aluminium base & Acrylic - Landscape | 8.961 lbs | 9.65" X 13.78" X 3.39" (25 pcs) |
| USWMDNP057 | 5" X 7" | Aluminium base & Acrylic - Landscape | 0.485 lbs | 7.09" X 7.87" X 4.72" (10 pcs) |
| USWMDNP058 | 5.5" X 8.5" | Aluminium base & Acrylic - Landscape | 8.785 lbs | 9.65" X 13.78" X 3.39" (15 pcs) |
| USWMDNP081 | 8.5" X 11" | Aluminium base & Acrylic - Landscape | 10.604 lbs | 9.65" X 13.78" X 3.39" (10 pcs) |

*W:Width H: Height D: Depth

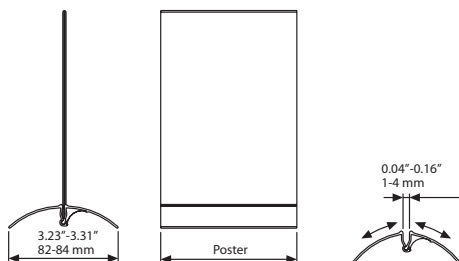

Pet Pocket U+C+D Type

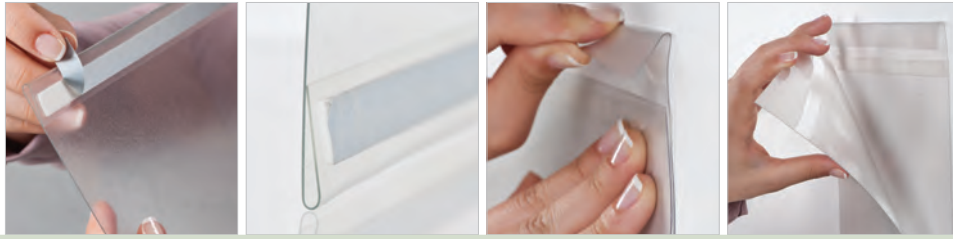

Anti-clear high resistant PET transparent clear document holders. Ideal for the display of menus at the restaurants, price lists, etc... They are suitable for screen printing. Non standard sizes can be produced to customer specification & needs; for printing and quantities please contact our sales executives.

! Please handle with care during transportation.

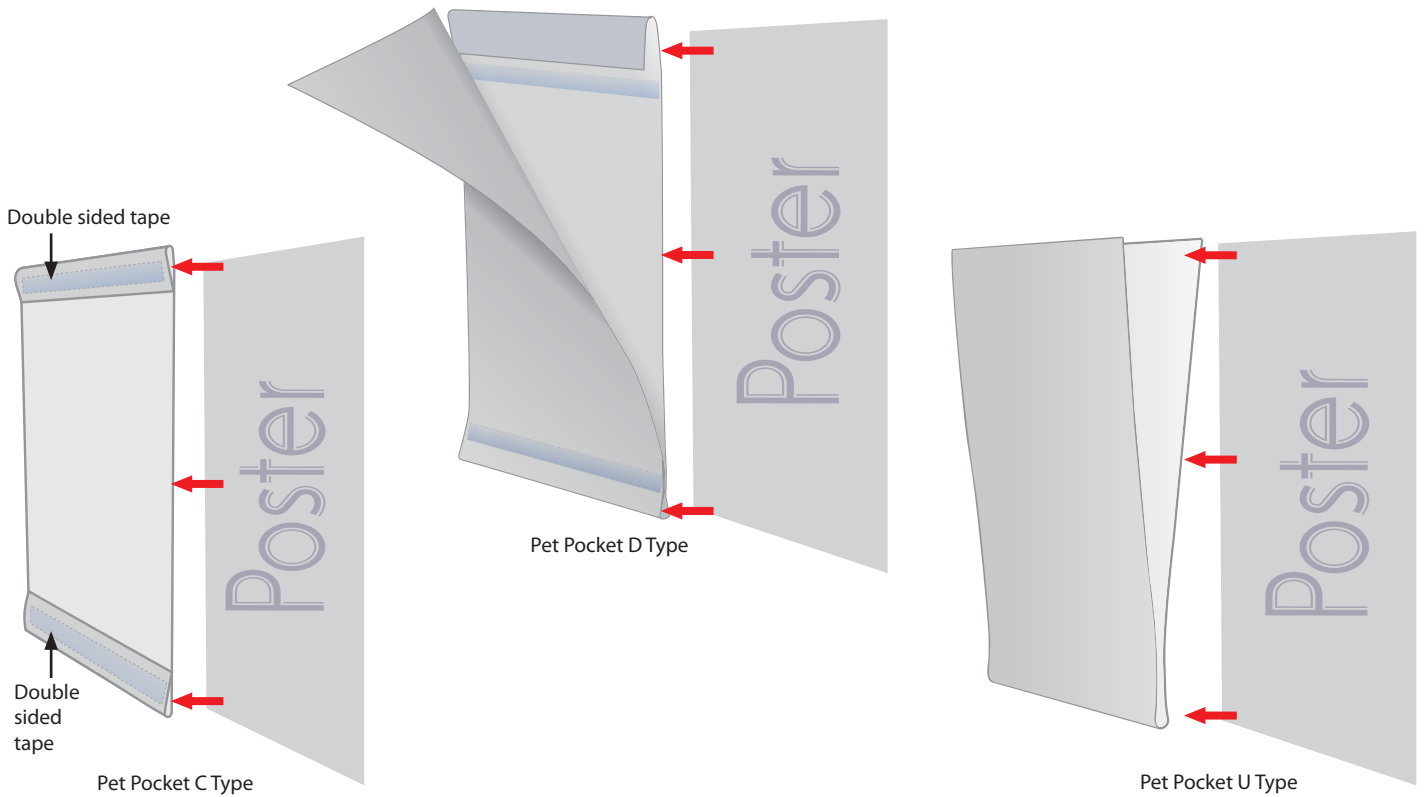

Pet Pocket D Type

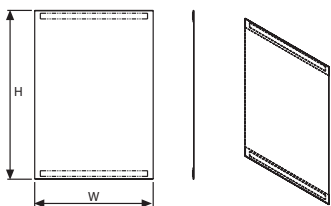

Pet Pocket C Type

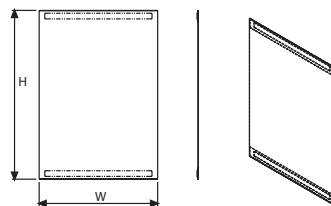

Pet Pocket U Type

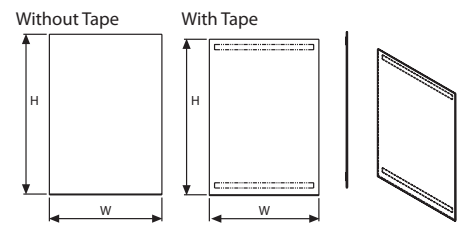



Pet Pocket , no tools required, mount it in less than a minute!

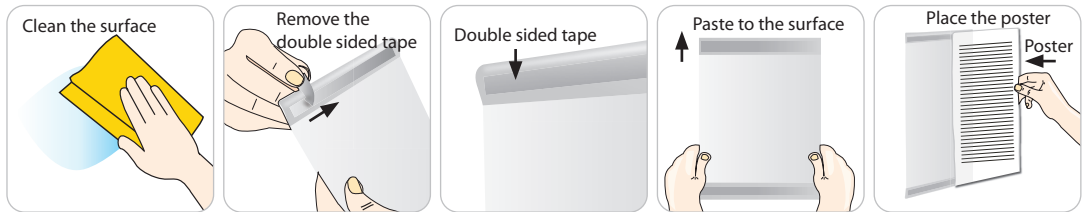

| PET POCKET C TYPE : Clear | | | | | WEIGHT | PACKING SIZE |
|---------------------------|------------|----------------------|------|--------|--------------|----------------------------------|
| ARTICLE | POSTER | DESCRIPTION | W | H | WITH PACKING | *W X H X D |
| UPCC1D0081 | 8.5" X 11" | 8.5" X 11" Portrait | 8.5" | 11.14" | 2.425 lbs | 10.04" X 12.99" X 3.35" (25 pcs) |
| UPCC1Y0081 | 8.5" X 11" | 8.5" X 11" Landscape | 11" | 8.62" | 2.425 lbs | 10.04" X 12.99" X 3.35" (25 pcs) |
| UPCC1D0057 | 5" X 7" | 5" X 7" Portrait | 5" | 7.13" | 1.984 lbs | 6.50" X 9.06" X 3.35" (50 pcs) |
| UPCC1Y0057 | 5" X 7" | 5" X 7" Landscape | 7" | 5.12" | 1.984 lbs | 6.50" X 9.06" X 3.35" (50 pcs) |

| PET POCKET D TYPE : Clear | | | | | WEIGHT | PACKING SIZE |
|---------------------------|------------|----------------------|------|--------|--------------|----------------------------------|
| ARTICLE | POSTER | DESCRIPTION | W | H | WITH PACKING | *W X H X D |
| UPCD1D0081 | 8.5" X 11" | 8.5" X 11" Portrait | 8.5" | 11.14" | 4.629 lbs | 10.04" X 12.99" X 3.35" (25 pcs) |
| UPCD1Y0081 | 8.5" X 11" | 8.5" X 11" Landscape | 11" | 8.62" | 4.629 lbs | 10.04" X 12.99" X 3.35" (25 pcs) |
| UPCD1D0057 | 5" X 7" | 5" X 7" Portrait | 5" | 7.13" | 3.747 lbs | 6.50" X 9.06" X 3.35" (50 pcs) |
| UPCD1Y0057 | 5" X 7" | 5" X 7" Landscape | 7" | 5.12" | 3.747 lbs | 6.50" X 9.06" X 3.35" (50 pcs) |

| PET POCKET U TYPE : Clear | | | | | | WEIGHT | PACKING SIZE |
|---------------------------|------------|------------|----------------------|------|--------|--------------|----------------------------------|
| WITHOUT TAPE | WITH TAPE | POSTER | DESCRIPTION | W | H | WITH PACKING | *W X H X D |
| UPCU0D0081 | UPCU1D0081 | 8.5" X 11" | 8.5" X 11" Portrait | 8.5" | 11.06" | 9.920 lbs | 10.04" X 12.99" X 3.35" (25 pcs) |
| UPCU0Y0081 | UPCU1Y0081 | 8.5" X 11" | 8.5" X 11" Landscape | 11" | 8.54" | 9.920 lbs | 10.04" X 12.99" X 3.35" (25 pcs) |
| UPCU0D0057 | UPCU1D0057 | 5" X 7" | 5" X 7" Portrait | 5" | 7.05" | 4.629 lbs | 6.50" X 9.06" X 3.35" (50 pcs) |
| UPCU0Y0057 | UPCU1Y0057 | 5" X 7" | 5" X 7" Landscape | 7" | 5.04" | 4.629 lbs | 6.50" X 9.06" X 3.35" (50 pcs) |

*W:Width H: Height D: Depth



Foldable Leaflet Holder

Upright Leaflet Holder



It's a foldable, light weight injected unit. Affordable way to present advertisements, price on product information, warnings on menus at various commercial environments.

Upright leaflet holder is an ideal plastic frame for prints. It serves as a menu holder or frame for advertisements. It's a light weight and double sided unit. Prints are easy to change from top & sides.

! Please handle with care during transportation.

Foldable Leaflet Holder



5" X 7" portrait



4" X 6" portrait

Upright Leaflet Holder



8.5" X 11" portrait



5" X 7" portrait



4" X 6" portrait

Foldable Leaflet Holder

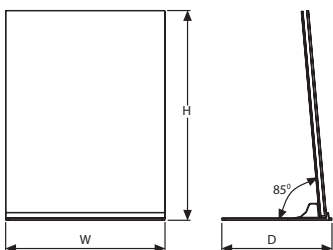

Upright Leaflet Holder

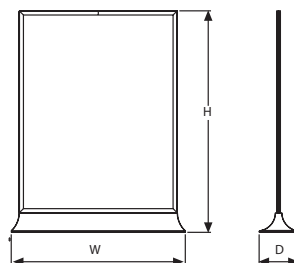

| UPRIGHT LEAFLET HOLDER: Clear | | | | | WEIGHT | PACKING SIZE (25 Pcs) |
|--------------------------------|------------|-------|--------|-------|--------------|--------------------------|
| ARTICLE | POSTER | W | H | D | WITH PACKING | *W X H X D |
| UMSDTLDN46 | 4" X 6" | 5.12" | 7.17" | 1.57" | 5.621 lbs | 8.27" X 12.60" X 11.42" |
| UMSDTLDN57 | 5" X 7" | 6.30" | 8.35" | 1.81" | 9.369 lbs | 9.45" X 14.57" X 14.17" |
| UMSDTLDN81 | 8.5" X 11" | 9.84" | 12.52" | 2.20" | 19.621 lbs | 16.93" X 27.56" X 10.24" |
| FOLDABLE LEAFLET HOLDER: Clear | | | | | WEIGHT | PACKING SIZE (25 Pcs) |
| ARTICLE | POSTER | W | H | D | WITH PACKING | *W X H X D |
| UMSDFLDN46 | 4" X 6" | 4.06" | 6.26" | 3.94" | 5.511 lbs | 8.66" X 11.02" X 10.24" |
| UMSDFLDN57 | 5" X 7" | 5.04" | 7.28" | 4.33" | 8.487 lbs | 9.84" X 11.02" X 12.20" |

*W:Width H: Height D: Depth



Oval Leaflet Holder

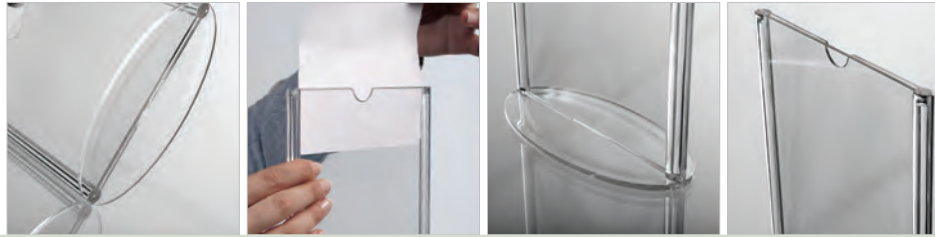

Modern style leaflet holder is light and affordable. Unit is injection molded, clear and double sided. Suitable for use as menucards in restaurants as leaflet holder in shops and any commercial environment.

! Please handle with care during transportation.



8.5" X 11" portrait



5" X 7" portrait



4" X 6" portrait

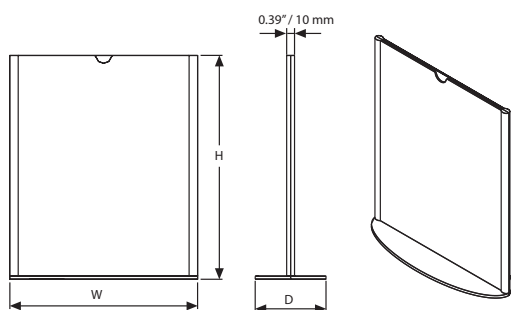

| MATERIAL : Clear | | | | | WEIGHT | PACKING SIZE (25 Pcs) |
|------------------|------------|-------|--------|-------|--------------|--------------------------|
| ARTICLE | POSTER | W | H | D | WITH PACKING | *W X H X D |
| UMSDOLDN46 | 4" X 6" | 4.88" | 6.18" | 2.56" | 6.338 lbs | 11.42" X 12.99" X 7.87" |
| UMSDOLDN57 | 5" X 7" | 5.91" | 7.20" | 2.76" | 9.259 lbs | 13.39" X 14.17" X 9.06" |
| UMSDOLDN81 | 8.5" X 11" | 9.45" | 11.20" | 3.54" | 22.156 lbs | 16.93" X 21.26" X 12.99" |



*W:Width H: Height D: Depth



Duo Desktop Menu Holder, Straight Cut & Vintage Cut



Modern style beech wood menu holder is light and affordable. Suitable for use in restaurants, retail stores and any commercial environment. Simply slide the leaflet into grooves of the wooden columns and place the menu between wooden columns and back support. Prints are easy to change from top. Duo Desktop Menu Holder are made of the finest materials while providing the highest level of quality. Basic and vintage styles offers options to users. To ensure sustainability of the quality in use, wood menu holders are lacquered finished which is resistant to spill of food and fizzy drinks.

-  Acrylic or PET poster pockets and chalkboards are optional.
-  Grooves of wooden columns is 0.18" which accepts acrylic or PET pockets and chalk board.
-  Packed in multiples.



Duo Desktop Menu Holder, Straight Cut, Dark Wood



Dark Wood - A4
PET optional



Dark Wood - A5
Acrylic optional



Natural Wood - A4
Chalkboard optional

Do not forget to order PET, or Acrylic pockets or Chalkboard

Duo Desktop Menu Holder, Straight Cut

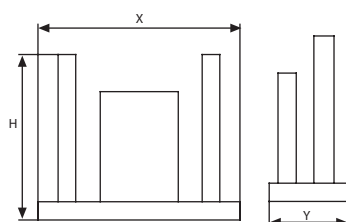

| DUO DESKTOP MENU HOLDER, STRAIGHT CUT: Beech wood | | | | | | WEIGHT | PACKING SIZE (2 Pcs) |
|---|-----------|--------------|--------|-------|-------|--------------|-------------------------|
| ARTICLE | SIZE | DESCRIPTION | X | Y | H | WITH PACKING | *W X H X D |
| UWDMODNOA4 | 8.5"X11" | Natural Wood | 11.30" | 3.35" | 9.84" | 3.692 lbs | 11.42" X 12.20" X 3.94" |
| UWDMODNOA5 | 5.5"X8.5" | Natural Wood | 8.66" | 3.35" | 7.09" | 2.645 lbs | 8.66" X 9.45" X 3.94" |
| UWDMODDOA4 | 8.5"X11" | Dark Wood | 11.30" | 3.35" | 9.84" | 3.692 lbs | 11.42" X 12.20" X 3.94" |
| UWDMODDOA5 | 5.5"X8.5" | Dark Wood | 8.66" | 3.35" | 7.09" | 2.645 lbs | 8.66" X 9.45" X 3.94" |



*W:Width H: Height D: Depth

Fort Desktop Menu Holder, Straight Cut & Vintage Cut



Modern style, made of beech wood, Fort Desktop Menu Holder is light and affordable solution for restaurants, retail stores and any commercial environment. Simply slide the leaflet into grooves of the wooden columns. Prints are easy to change from top. Fort Desktop Menu Holder is made of the finest materials while providing the highest level of quality. Basic and vintage styles offers options to users. To ensure sustainability of the quality, wood menu holders are lacquered finished which is resistant to spill of food and fizzy drinks.



Acrylic or PET poster pockets and chalkboards are optional.



Frooves of wooden columns is 0.18" which accepts acrylic or PET pockets and chalk board.



Packed in multiples.

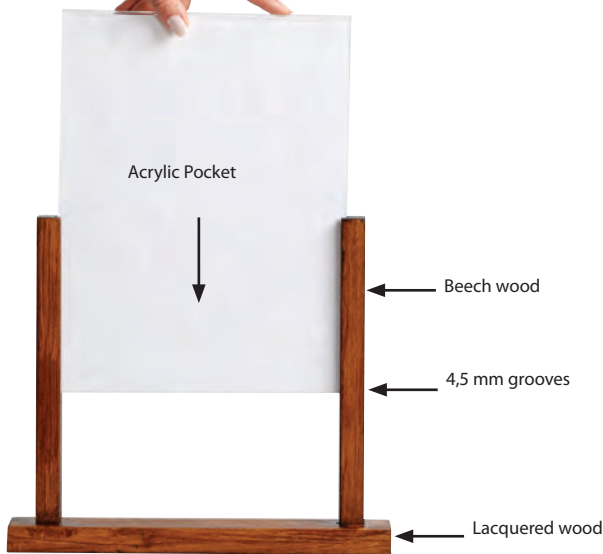

Fort Desktop Menu Holder, Straight Cut, Dark Wood



Dark Wood - A4
PET optional



Dark Wood - A5
Acrylic optional



Natural Wood - A5
Chalkboard optional

Do not forget to order PET, or Acrylic pockets or Chalkboard

Fort Desktop Menu Holder, Straight Cut

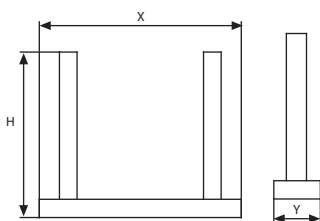

Fort Desktop Menu Holder, Vintage Cut

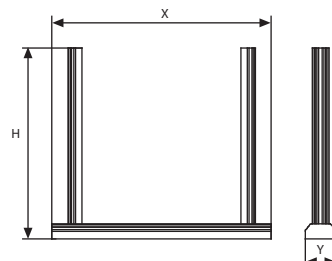

| FORT DESKTOP MENU HOLDER, STRAIGHT CUT : Beech wood | | | | | | WEIGHT | PACKING SIZE (2 Pcs) |
|---|-----------|--------------|--------|-------|-------|--------------|-------------------------|
| ARTICLE | SIZE | DESCRIPTION | X | Y | H | WITH PACKING | *W X H X D |
| UWDMOFNOA4 | 8.5"X11" | Natural Wood | 11.30" | 1.57" | 9.84" | 1.807 lbs | 11.42" X 12.20" X 3.94" |
| UWDMOFNOA5 | 5.5"X8.5" | Natural Wood | 8.66" | 1.57" | 7.09" | 1.234 lbs | 8.66" X 9.45" X 3.94" |
| UWDMOFDOA4 | 8.5"X11" | Dark Wood | 11.30" | 1.57" | 9.84" | 1.807 lbs | 11.42" X 12.20" X 3.94" |
| UWDMOFDOA5 | 5.5"X8.5" | Dark Wood | 8.66" | 1.57" | 7.09" | 1.234 lbs | 8.66" X 9.45" X 3.94" |



* W:Width H: Height D: Depth

Curved Desktop Menu Holder



Modern style beech plywood menu holder is light and affordable. Suitable for use in restaurants, retail stores and any commercial environment. Simply slide the leaflets in to PET pocket and then slide the PET pocket in to grooves of the wooden columns. Prints are easy by sliding in. Curved Menu Holders are made of the finest materials while providing the highest level of quality. To ensure sustainability of the quality, wood menu holders are lacquered finished which is resistant to spill of food and fizzy drinks.



No tool assembly.



Channel of wooden columns is 0.17"



PET pocket included.



Dark Wood - 8.5"x11"



Dark Wood - 5x5"x8.5"



Natural Wood - 8.5"x11"



Natural Wood - 5x5"x8.5"

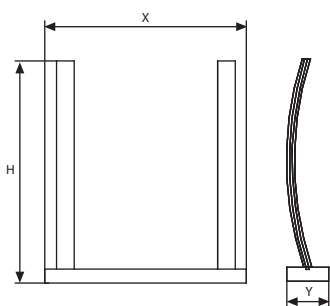

| MATERIAL : Beech wood | | | | | | WEIGHT | PACKING SIZE (2 Pcs) |
|-----------------------|------------|-----------|--------|-------|--------|--------------|-------------------------|
| NATURAL WOOD | DARK WOOD | SIZE | X | Y | H | WITH PACKING | *W X H X D |
| UWDMOCN058 | UWDMOCD058 | 5.5"x8.5" | 8.66" | 2.36" | 8.66" | 1.653 lbs | 9.84" X 11.02" X 3.15" |
| UWDMOCN081 | UWDMOCD081 | 8.5"x11" | 11.34" | 2.36" | 12.52" | 2.204 lbs | 13.39" X 13.78" X 3.15" |



* W:Width H:Height D:Depth



Ticket Holder



Made of solid Beech wood, Ticker Holders are mobile options for displaying menus, business cards, price tickets, gift cards or many other purposes. It is nicely lacquered finished with round corners. It is good for displaying both ways. Ticket Holder is suitable for both indoor and outdoor places such as shops, restaurants, cafes and bars. To ensure sustainability of the quality, Ticket Holders are lacquered finished which is resistant to spill of food and fizzy drinks.

-  Each unit comes ready to use.
-  Groove is 0.08" and 90 degrees.
-  Packed in multiples. Suitable for silk screen printing, max. letter height is 0.47"

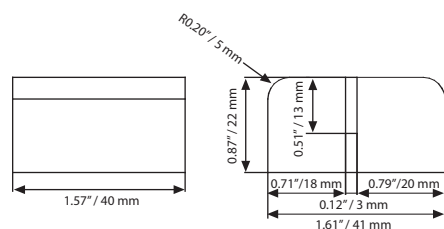
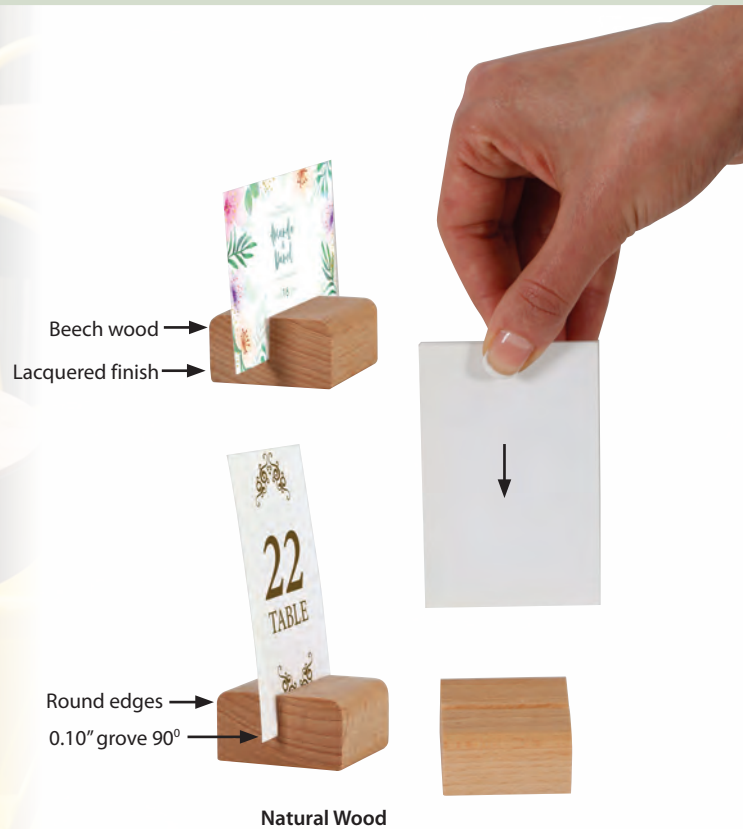

| MATERIAL : Beech wood | | | WEIGHT | PACKING SIZE (10 Pcs) |
|-----------------------|------------|--------------|--------------|-----------------------|
| ARTICLE | SIZE | DESCRIPTION | WITH PACKING | *W X H X D |
| UWTHON0010 | 40 X 41 mm | Natural Wood | 0.749 lbs | 4.13" X 4.13" X 3.15" |
| UWTHOD0010 | 40 X 41 mm | Dark Wood | 0.749 lbs | 4.13" X 4.13" X 3.15" |



*W:Width H: Height D: Depth

Card Holder 2 Sided



Made of solid Beech wood, Card Holder is double sided mobile options for displaying menus, business cards, price tickets, gift cards or many other purposes. It is nicely lacquered finished with round corners. It is good for displaying both ways. There are one channel on each side of Card holder one of which is 90 degrees angle and other one of which is 75 degrees angle. Card Holder is suitable for both indoor and outdoor places such as shops, restaurants, cafes and bars. To ensure sustainability of the quality, Card Holder is lacquered finished which is resistant to spill of food and fizzy drinks.



Each unit comes ready to use
Jeder Artikel wird fertig zum Einsatz geliefert.



Both groove is 4,5 mm, one of which is 90 degrees and other one is 75 degrees.
Beide Nuten sind 4,5 mm, eine davon ist 90 Grad und die andere 75 Grad.



Packed in multiples. Suitable for silk screen printing, max. letter height is 18 mm.
Vielfachpackung. Für Siebdruck geeignet max. Buchstabenhöhe 18 mm.

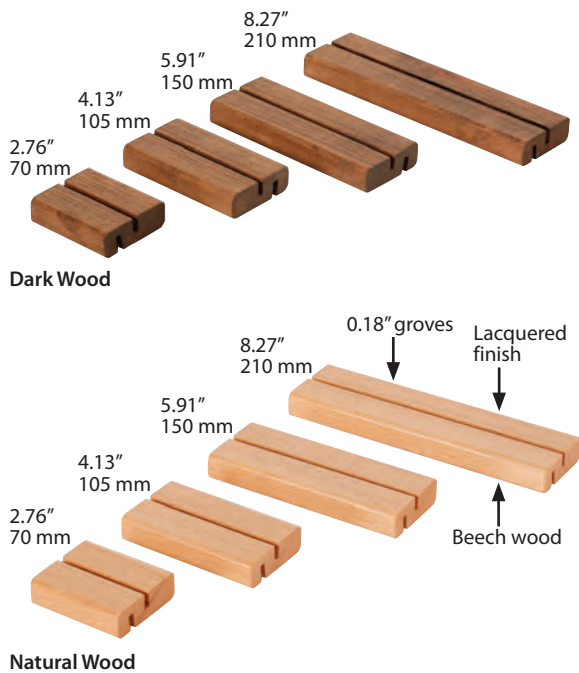

Dark Wood 75°Angled
8.27", Acrylic optional



Dark Wood 90°Angled
8.27", Chalkboard optional



Dark Wood 90°Angled
5.91", Acrylic optional



Natural Wood 90°Angled
4.13", Acrylic optional



Natural Wood 75°Angled
4.13", Chalkboard optional



Natural Wood 75°Angled
2.76", Acrylic optional

Do not forget to order PET, or Acrylic pockets or Chalkboard

| ACRYLIC POCKET U TYPE | | | |
|-----------------------|-------------|-------|--------|
| ARTICLE | POSTER | W | H |
| UPCUAD0081 | 8.5" X 11" | 8.5" | 11.18" |
| UPCUAD0058 | 5.5" X 8.5" | 5.83" | 8.66" |

| PET POCKET U TYPE | | | |
|-------------------|-------------|-------|--------|
| ARTICLE | POSTER | W | H |
| UPCUPD0081 | 8.5" X 11" | 8.5" | 11.10" |
| UPCUPD0058 | 5.5" X 8.5" | 5.83" | 8.58" |

| CHALKBOARD | | | |
|------------|--------------|--------|--------|
| ARTICLE | SIZE | W | H |
| UPCUWD0081 | 216 X 280 mm | 216 mm | 283 mm |
| UPCUWD0058 | 140 X 216 mm | 148 mm | 219 mm |

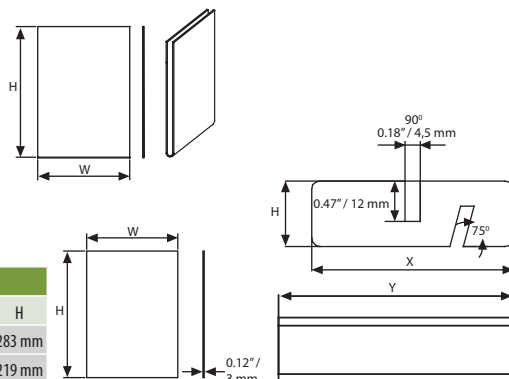

| MATERIAL : Beech wood | | | | | | WEIGHT | PACKING SIZE (10Pcs) |
|-----------------------|-------|--------------|-------|-------|-------|--------------|-----------------------|
| ARTICLE | SIZE | DESCRIPTION | X | Y | H | WITH PACKING | *W X H X D |
| UWCHON0070 | 2.76" | Natural Wood | 2.36" | 2.76" | 0.79" | 1.565 lbs | 3.94" X 5.91" X 5.51" |
| UWCHON0105 | 4.13" | Natural Wood | 2.36" | 4.13" | 0.79" | 2.314 lbs | 5.31" X 5.91" X 5.51" |
| UWCHON0150 | 5.91" | Natural Wood | 2.36" | 5.91" | 0.79" | 3.196 lbs | 7.09" X 5.91" X 5.51" |
| UWCHON0210 | 8.27" | Natural Wood | 2.36" | 8.27" | 0.79" | 4.409 lbs | 5.91" X 230 X 5.51" |
| UWCHOD0070 | 2.76" | Dark Wood | 2.36" | 2.76" | 0.79" | 1.565 lbs | 3.94" X 5.91" X 5.51" |
| UWCHOD0105 | 4.13" | Dark Wood | 2.36" | 4.13" | 0.79" | 2.314 lbs | 5.31" X 5.91" X 5.51" |
| UWCHOD0150 | 5.91" | Dark Wood | 2.36" | 5.91" | 0.79" | 3.196 lbs | 7.09" X 5.91" X 5.51" |
| UWCHOD0210 | 8.27" | Dark Wood | 2.36" | 8.27" | 0.79" | 4.409 lbs | 5.91" X 230 X 5.51" |





*W:Width H: Height D: Depth

Pyramid Card Holder Single Sided



Made of solid Beech wood, Pyramid Card Holder is mobile option for displaying menus, business cards, price tickets, or many other announcement purposes. It is nicely lacquered finished with round corners. It is good for displaying both ways. Pyramid Card Holder is suitable for both indoor and outdoor places such as shops, restaurants, cafes and bars. To ensure sustainability of the quality, Pyramid Card Holders are lacquered finished which is resistant to spill of food and fizzy drinks.

-  Each unit comes ready to use
Jeder Artikel wird fertig zum Einsatz geliefert.
-  Groove is 4,5 mm and 90 degrees. Suitable for branding.
Die Nut ist 4,5 mm und 90 Grad. Können mit Marke versehen werden
-  Packed in multiples. Suitable for silk screen printing, max. letter height is 25 mm.
In Vielfachpackungen. Für Siebdruck geeignet max. Buchstabenhöhe 25 mm.

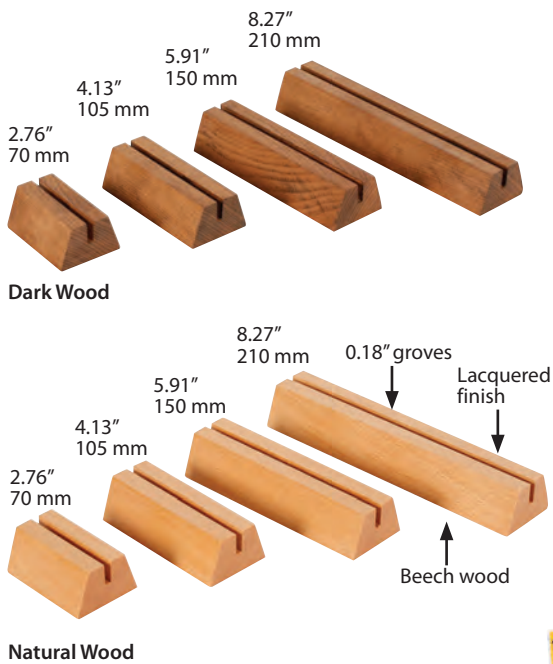

Dark Wood - 8.27"
Acrylic optional



Dark Wood - 5.91"
Chalkboard optional



Dark Wood - 4.13"
Acrylic optional



Dark Wood - 2.76"
Chalkboard optional



Natural Wood - 2.76"
Acrylic optional



Natural Wood - 4.13"
Chalkboard optional



Natural Wood - 5.91"
Acrylic optional



Natural Wood - 8.27"
Chalkboard optional

Do not forget to order PET, or Acrylic pockets or Chalkboard

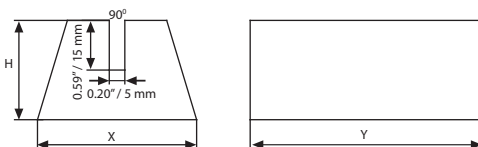

| MATERIAL : Beech wood | | | | | | WEIGHT | PACKING SIZE (10Pcs) |
|-----------------------|-------|--------------|-------|-------|-------|--------------|-----------------------|
| ARTICLE | SIZE | DESCRIPTION | X | Y | H | WITH PACKING | *W X H X D |
| UWCHPN0070 | 2.76" | Natural Wood | 1.89" | 2.76" | 1.18" | 1.565 lbs | 3.15" X 9.84" X 3.54" |
| UWCHPN0105 | 4.13" | Natural Wood | 1.89" | 4.13" | 1.18" | 2.314 lbs | 3.15" X 9.84" X 5.12" |
| UWCHPN0150 | 5.91" | Natural Wood | 1.89" | 5.91" | 1.18" | 3.196 lbs | 3.15" X 9.84" X 6.69" |
| UWCHPN0210 | 8.27" | Natural Wood | 1.89" | 8.27" | 1.18" | 4.409 lbs | 3.15" X 9.84" X 9.06" |
| UWCHPD0070 | 2.76" | Dark Wood | 1.89" | 2.76" | 1.18" | 1.565 lbs | 3.15" X 9.84" X 3.54" |
| UWCHPD0105 | 4.13" | Dark Wood | 1.89" | 4.13" | 1.18" | 2.314 lbs | 3.15" X 9.84" X 5.12" |
| UWCHPD0150 | 5.91" | Dark Wood | 1.89" | 5.91" | 1.18" | 3.196 lbs | 3.15" X 9.84" X 6.69" |
| UWCHPD0210 | 8.27" | Dark Wood | 1.89" | 8.27" | 1.18" | 4.409 lbs | 3.15" X 9.84" X 9.06" |

*W:Width H: Height D: Depth





Arc Menu Holder



See movie at our website www.mtdisplays.com.tr



Modern style Arc Menu Holder features a curved design for more modernized appearance. With a contemporary design, this menu holder can be used to display notices, advertisements, graphics, menus and more. Flip up magnetic cover makes the change of poster easy. Simply flip up the anti-reflex cover and place the print underneath it. Suitable for use in restaurants, retail stores and any commercial environment.

-  No assembly required .
-  Unique curved design.
-  Magnetic PET cover included.

Color options



Silver Black / RAL 9005

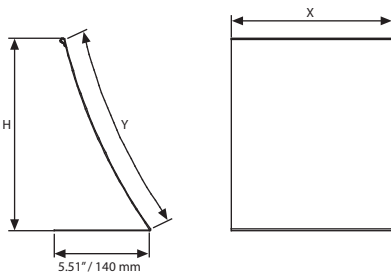

| MATERIAL : Sheet metal | | | | | | WEIGHT | PACKING SIZE |
|------------------------|----------------|------------|----------------|--------|-------------|--------------|-------------------------|
| ARTICLE | EXTERNAL (x-y) | POSTER | COPY | H | DESCRIPTOIN | WITH PACKING | *W X H X D |
| UMSAMP0G81 | 9.69" X 12.20" | 8.5" X 11" | 8.35" X 10.87" | 10.83" | Silver | 5.842 lbs | 7.28" X 13.58" X 10.63" |
| UMSAMP0B81 | 9.69" X 12.20" | 8.5" X 11" | 8.35" X 10.87" | 10.83" | Black | 5.842 lbs | 7.28" X 13.58" X 10.63" |



* W:Width H: Height D: Depth

Arc Menu Holder





Accessories

- Hangers
- Baskets
- Shelves
- Header Holder & Header
- Bags
- Levertool
- Separator
- Chalkboard Marker
- Lighting Components
- Panel
- Other



Accessories



Hanger / UYAA002100
Stopper on the frames for 1" double sided frames. Packed in 10.



Hanger / UYAA002200
Stopper on the frames for 1.26" double sided frames. Packed in 10.

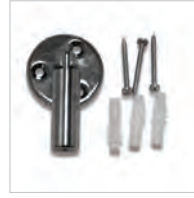

Hanger / UYAA000000
Ceiling and floor hanger for double sided frames. Packed in 5.



Hanger / UYAA001000
Ceiling hanger for double sided frames. Packed in 10.



Hanger / UYAA001100
Ceiling hanging kit for sizes B1, A0, B0, 30"x40", 40"x60". Packed in 10.



Hanger / UYAA007000
Plastic hanger for stretch frame. Packed in 10.



Hanger / UYAA004000
Wire Cable.



Hanger / UYAA006010
Suction cap for Wall Sign System. Packed in 10.



Hanger / UYAA001030
Ceiling hanger for double sided frames for small sizes. (8.5"x11" to 24"x36"). Packed in 10.



Hanger / UYAA001130
Ceiling hanger for double sided frames for big sizes. (27"x40" to 40"x60"). Packed in 10.



Hanger / UYAA006000
Suction cap for Stretch Frame. Packed in 10.



Hanger / UYAA005000
Ball chain for stretch frame.



Baskets / UYTS3000A4
A board basket 8.5"x11" size to hang on scissors.



Shelf / UFSL002000
Steel shelf for Display Stans.

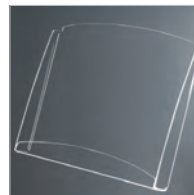

Shelf / UFSL003000
Acrylic shelf for Display Stans.



Shelf / UFSL120000
Acrylic shelf for Display Stans. 8.5"x11".



Shelf / UFSL002100
2x(5.5"x8.5") Steel shelf for Display Stans & Adjustable Menuboard.

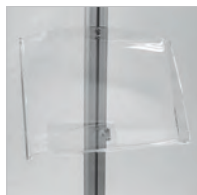

Shelf / UFSL003100
2x(5.5"x8.5") Acrylic shelf for Display Stans & Adjustable Menuboard.



Shelf / UFSL002200
1x (8.5"x11") Steel shelf for Display Stans.

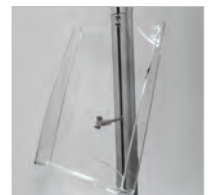

Shelf / UFSL003200
1x (8.5"x11") Acrylic shelf for Free Standing Leaflet.

For the packing details and minimum quantities please contact our sales executives.

Accessories



Shelf / UFSL003300
1x(8.5"x11") Acrylic shelf for Free Standing.

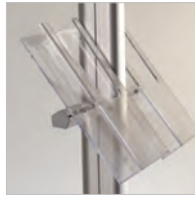

Shelf / UFSL145000
(8.5"x11") Acrylic side shelf for Free Standing Leaflet.

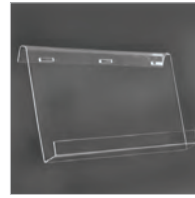

Shelf
Single sided acrylic shelves for Poster Stands and Brochure Sets.

| ARTICLE | SIZE |
|------------|------------------|
| UYRT0002A4 | 2 X (8.5" X 11") |
| UYRT0003A4 | 3 X (8.5" X 11") |

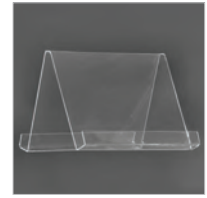

Shelf
Double sided acrylic shelves for Poster Stands and Brochure Sets.

| ARTICLE | SIZE |
|------------|------------------|
| UYRC0002A4 | 4 X (8.5" X 11") |
| UYRC0003A4 | 6 X (8.5" X 11") |



Shelf / UFSL002560
MDF shelf for Display Stans.



Shelf / UFSL002500
MDF shelf for Display Stans.

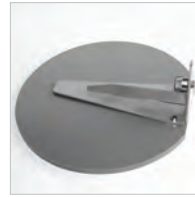

Shelf / UFSL002550
MDF shelf for Display Stans.



Shelf / UFSL002510
MDF shelf for Display Stans.



Shelf / UYMGB00000
Shelf for Magnetic Glass Board.



Header / UFSL120200
Free Standing Leaflet Dispensers with Side Shelf header.



Header / UFSL120100
Free Standing Leaflet Dispensers header.



Header
Swingpro® Lite & Windpro® Lite header (PVC Foam).

| ARTICLE | SIZE |
|------------|-----------|
| UYFT004022 | 22" X 28" |
| UYFT004024 | 24 X 36" |
| UYFT004034 | 30" X 40" |
| UYFT004084 | 28" X 44" |



Header
Eco Swingmaster & Eco Waterbase Wind Sign header (PVC Foam).

| ARTICLE | SIZE |
|------------|-----------|
| UYFT005022 | 22" X 28" |
| UYFT005023 | 20" X 30" |
| UYFT005024 | 24 X 36" |
| UYFT005034 | 30" X 40" |
| UYFT005046 | 40" X 60" |



Header
Swingpro® Plus & Windpro® Plus header (PVC Foam).

| ARTICLE | SIZE |
|------------|-----------|
| UYFT005022 | 22" X 28" |
| UYFT005023 | 20" X 30" |
| UYFT005024 | 24 X 36" |
| UYFT005034 | 30" X 40" |
| UYFT0050F0 | F0 |



Header
A Board header (PVC Foam).

| ARTICLE | SIZE | DESCRIPTION |
|------------|-----------|-------------|
| UYFT000023 | 20" X 30" | for 0.16" |
| UYFT000022 | 22" X 28" | for 0.16" |
| UYFT000024 | 24" X 36" | for 0.16" |
| UYFT000034 | 30" X 40" | for 0.16" |
| UYFT250022 | 20" X 30" | for 1" |
| UYFT250024 | 24" X 36" | for 1" |

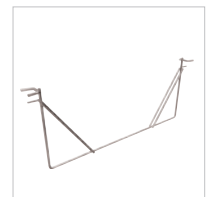

Header Holder
A Board wire header holder.

| ARTICLE | SIZE | DESCRIPTION |
|------------|-----------|-------------|
| UYTT000023 | 20" X 30" | for 0.16" |
| UYTT000022 | 22" X 28" | for 0.16" |
| UYTT000024 | 24" X 36" | for 0.16" |
| UYTT000034 | 30" X 40" | for 0.16" |
| UYTT250022 | 20" X 30" | for 1" |
| UYTT250024 | 24" X 36" | for 1" |

For the packing details and minimum quantities please contact our sales executives.

Accessories



Bag
Black carry bag for single sided Quick Banner, Adjustable Quick Banner, single sided Smart Roll Banner.

| ARTICLE | SIZE |
|------------|---------|
| UYUP064000 | 800 mm |
| UYUP065000 | 1080 mm |
| UYUP066000 | 880 mm |
| UYUP067000 | 1030 mm |



Bag
Black carry bag for Eco-roller.

| ARTICLE | SIZE |
|------------|--------|
| UYUP070500 | 800 mm |
| UYUP070600 | 1000mm |



Bag
Black carry bag for double sided Smart Roll Banner.

| ARTICLE | SIZE |
|------------|--------|
| UYUP070000 | 800 mm |
| UYUP071000 | 1000mm |



Bag / UYUP072000
Black carry bag for Portable Zick-Zack 18.90" x 19.69" x 10.63".



Bag / UPP0110000
Pop-up carry bag for all size.



Bag / UYP0TS2050
Bag for Seed Promostand with pole system.



Bag / UYUP072200
Bag for Promostand.



Bag / UYUP072300
Bag for Petit Promostand.



Bag / UYP0TS1050
Bag for Seed, Rectangular, Circle and Bean Promostands.



Bag / UYUP074000
Convex Panset counter table black carry bag.



Bag / UYUP075100
Panset black carry bag for logo for all size.



Bag / UYUP076100
Panset black carry bag main body for all size.



Bag / UYUP070200
Midsize Convex Panset counter table black carry bag.



Bag / UYUP074100
Hexagonal Panset counter table black carry bag.



Bag / UYUP072400
Black carry bag for Newage Portable Zick-Zack 14.96" x 18.50" x 211.02".



Levertool / UYUP047000
Levertool in Plastic for Security Frames 1" - 1.26". Packed in 20.



Levertool / UYUP047100
Levertool in Plastic for Security Frames 1.65". Packed in 20.



Lighting Component / UYUP367130
Lighting for Pop-ups.



Chalkboard Marker / UYAKLM1251
Colour chalkboard marker for Wood Display. 0.39" wide. 5 Pcs.



Chalkboard Marker / UYAKLM1250
White chalkboard marker for Wood Display. 0.39" wide. 3 Pcs.

For the packing details and minimum quantities please contact our sales executives.

Accessories



Panel
Easy go PVC
Foam panel.

| PVC FOAM PANEL | SIZE |
|----------------|-----------|
| UYPEG30022 | 22" X 28" |
| UYPEG30024 | 24" X 36" |



Panel
Easy go chalk panel.

| CHALK PANEL | SIZE |
|-------------|-----------|
| UYPEG10022 | 22" X 28" |
| UYPEG10024 | 24" X 36" |



Panel
Easy go write-on panel.

| WRITE-ON PANEL | SIZE |
|----------------|-----------|
| UYPEG20022 | 22" X 28" |
| UYPEG20024 | 24" X 36" |



Panel
Panel for Outdoor Flap
Gripper.

| ARTICLE | SIZE |
|------------|-----------------|
| UYOFG10610 | 24.41" X 39.37" |
| UYOFG10612 | 24.41" X 47.24" |
| UYOFG10615 | 24.41" X 59.06" |



Other / TSTDCI450B
Cable for all iPhones
& iPads. 3m Black.



Other / TSTDCIP40B
Cable for iPhone 4S,
iPad 3 and earlier.
3m Black.



Other / TSTDCIP50B
Cable for iPhone 5, iPad
4 and later. 3m Black.



Other / TSTDCV80B
Cable V8, micro USB for
Samsung, LG etc...



Other / UYPPD00000
USB Adaptor Lightning
to 30-pin.



Other / UYUP480945
WindPro Carriage tool.

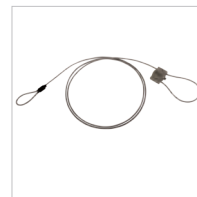

Other / TZZZ998701
Cable Lock System
length 78.74", with
combination lock.



Other / UYTFB00000
Acrylic magnetic tray
for board marker .
Packed in 1.



Other / UQRP00L000
Blue-Chrome rope for
Q Ropes. Length 78.74"



Other / UQRP00B000
Black-Chrome rope for
Q Ropes. Length 78.74"



Other / UQRP00R000
Red-Chrome rope for
Q Ropes. Length 78.74"



Other / TWBTRT0210
Red-Gold rope for
Q Ropes. Length 118.11"



Other / UYUP397000
Magnetic buttons for
Boards. Packed in 10.



Other / UYUP397100
Pins for Boards.
Packed in 20.



Other / UYPOTS0030
Velcro Roll with double
sided tape 59 ft.

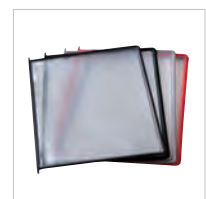

Poster Pocket
10 pcs of 1 colour in a box.

| ARTICLE | PAPER SIZE | DESCRIPTION |
|------------|------------|-------------|
| TAB0590104 | 8.5" X 11" | Red |
| TAB0590101 | 8.5" X 11" | Black |
| TAB0590109 | 8.5" X 11" | Grey |

For the packing details and minimum quantities please contact our sales executives.

Accessories



Grey Felt
Grey felt for Promostand.

| ARTICLE | DESCRIPTION | SIZE |
|------------|--------------------------------------|----------|
| UYPOTSC03G | for Seed Promostand | 35.43" |
| UYPOTSP03G | for Seed Promostand with Pole System | 35.43" |
| UYPOTSD03G | for Rectangular Promostand | 35.43" |
| UYPOTSR03G | for Circle Promostand | Ø 23.62" |
| UYPOTSB03G | for Bean Promostand | 35.43" |



Dimmer / UYUP445550
Optional dimmer to go with LED illuminated frame... Simply jack the dimmer in frame and then into powersupply. It adjust the light from dark to max lux of LED illuminated frame.



Semi Products

- Profiles
- Corners
- Connectors
- Springs
- End Caps
- Hangers
- Pipes
- Feet
- Counter Support
- Logo
- Shelf
- Panel
- Power Supply
- Base
- Others

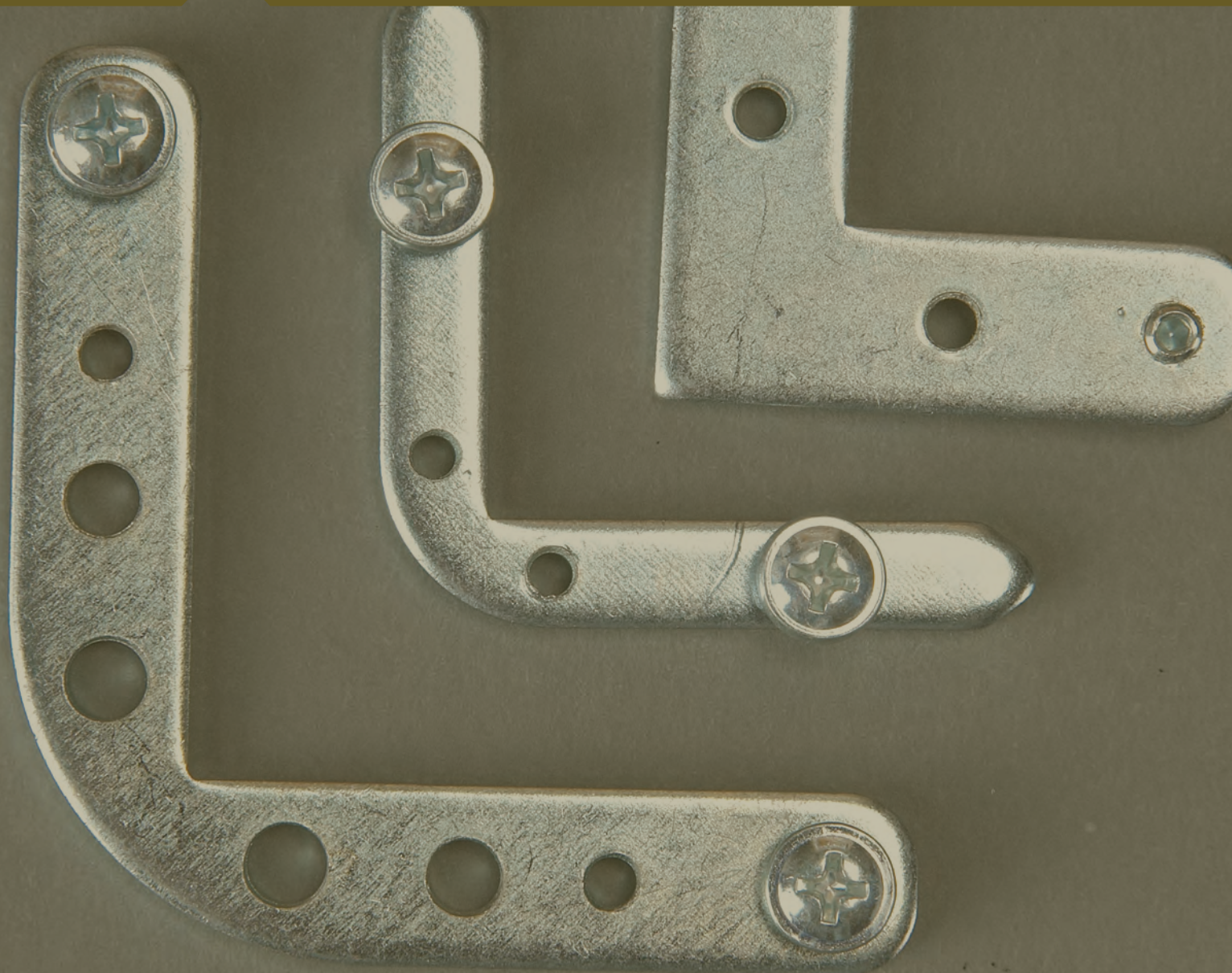

Semi Products



Profile / UYUP007700
0.59" Aluminium Snap profile set (top & bottom) in 118.11" without springs. Top Profile is silver anodized. Bottom profile is mill finished.



Profile / UYUP001000
0.79" Aluminium Snap profile set (top & bottom) in 118.11" without springs. Top Profile is silver anodized. Bottom profile is mill finished.



Profile / UYUP002000
1" Aluminium Snap profile set (top & bottom) in 118.11" without springs. Top Profile is silver anodized. Bottom profile is mill finished.



Profile / UYUP003400
26 mm Aluminium Snap profile set (top & bottom) in 118.11" without springs. Top Profile is silver anodized. Bottom profile is mill finished.

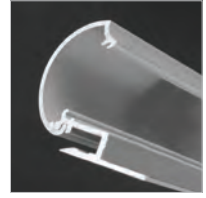

Profile / UYUP003300
1.02" Aluminium Poster Snap profile without springs & rubber. Top and bottom profiles are silver anodized.



Profile / UYUP003000
1.02" Aluminium Poster Snap profile with springs & rubber. Top and bottom profiles are silver anodized.



Profile / UYUP004000
1.18" Aluminium Snap profile set (top & bottom) in 118.11" without springs. Top Profile is silver anodized. Bottom profile is mill finished.

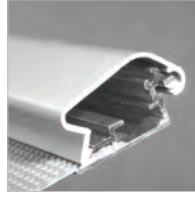

Profile / UYUP005000
1.26" Aluminium Snap profile set (top & bottom) in 118.11" without springs. Top Profile is silver anodized. Bottom profile is mill finished.



Profile / UYUP007800
1.50" Aluminium Snap profile set (top & bottom) in 118.11" without springs. Top Profile is silver anodized. Bottom profile is mill finished.

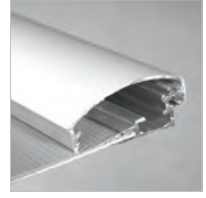

Profile / UYUP007000
1.77" Aluminium Snap profile set (top & bottom) in 118.11" without springs. Top Profile is silver anodized. Bottom profile is mill finished.

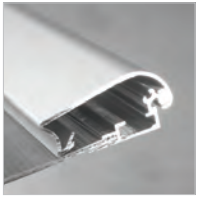

Profile / UYUP007200
1.81" Aluminium Snap profile set (top & bottom) in 118.11" without springs. Top Profile is silver anodized. Bottom profile is mill finished.

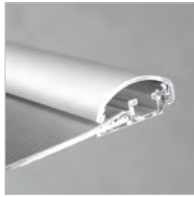

Profile / UYUP002100
1" Aluminium Security profile set (top & bottom) in 118.11" without springs. Top Profile is silver anodized. Bottom profile is mill finished.



Profile / UYUP008300
1.26" Aluminium Security profile set (top & bottom) in 118.11" without springs. Top Profile is silver anodized. Bottom profile is mill finished.

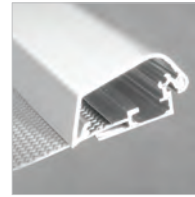

Profile / UYUP006000
1.65" Aluminium Security profile set (top & bottom) in 118.11" without springs. Top Profile is silver anodized. Bottom profile is mill finished.

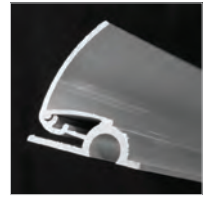

Profile / UYUP011000
Aluminium Poster Clamp profile. Top and bottom profiles are silver anodized.



Profile / UYUP013200
Aluminium Newage Poster Clamp profile. Top and bottom profiles are 118.11" silver anodized.

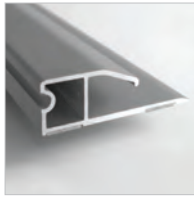

Profile / UYUP013100
Aluminium Fast Note Profile. 118.11" silver anodized.

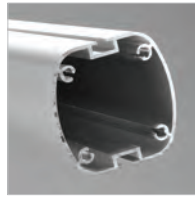

Profile / UYUP012500
Aluminium Display Stands profile 2 channel. 118.11" silver anodized.

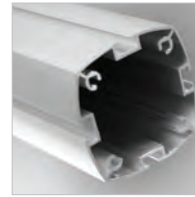

Profile / UYUP012550
Aluminium Display Stands profile 4 channel. 118.11" silver anodized.



Profile / UYUP012650
Novel Aluminium Display Stands profile 4 channel. 118.11" silver anodized.

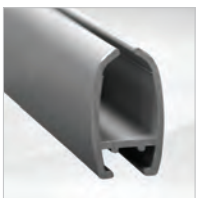

Profile / UYUP011200
Poster Fast profile 118.11" silver anodized.

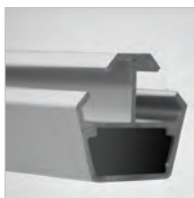

Profile / UYUP011900
Acrylic Side Shelf profile 118.11" silver anodized.

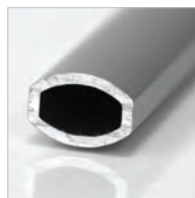

Profile / UYUP054000
Aluminium Stretch profile 118.11" silver anodized.

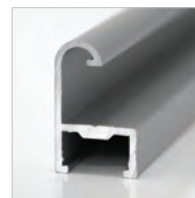

Profile / UYUP007920
0.35" Frameboard profile 118.11" silver anodized.

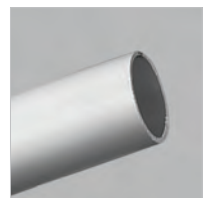

Profile / UYUP008000
Aluminium Circle Pipe profile 118.11" silver anodized Ø0.63".

For the packing details and minimum quantities please contact our sales executives.

Semi Products



Profile / UYUP007600
Aluminium profile for Free Standing Banner Set.



Profile / UYUP010000
2.01" Aluminium Elips profile silver anodized in 118.11".



Profile / UYUP009000
1.69" Aluminium Elips profile silver anodized in 118.11".

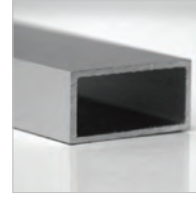

Profile / UYUP012000
Aluminium anodized profile rectangular.

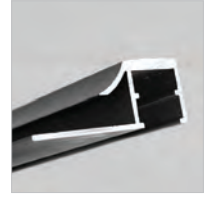

Profile / UYUP014850
Profile for single sided slide-in frame. 118.11", 2 channels.



Profile / UYUP014950
Profile for single sided slide-in frame. 118.11", 1 channels.

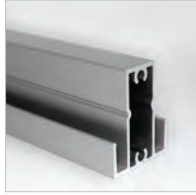

Profile / UYUP012400
Cocktail Brochure set profile. 118.11".



Profile / UYUP014800
Profile for double sided slide-in frame. 118.1", 2 channels.



Profile / UYUP014900
Profile for double sided slide-in frame. 118.11", 1 channels.



Profile / UYUP010510
Elips profile with channel.



Profile / UYUP012800
Multiside Brochure set & Rapid Brochure set profile. 118.11".

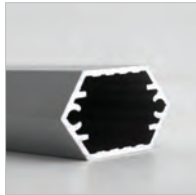

Profile / UYUP012900
Rapid Brochure set middle profile. 118.11".

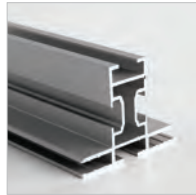

Profile / UYUP014101
Double Sided Maxi profile. King Frame Profile. 118.11", 1.97"x1.57".

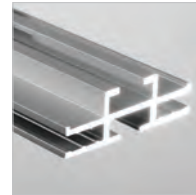

Profile / UYUP014104
Double Sided Maxi profile. Queen Frame Profile. 118.11", 1.77"x0.59".

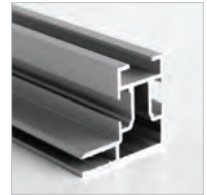

Profile / UYUP014102
Single Sided Maxi profile. Dame Frame Profile. 118.11", 1.34"x1.26".



Profile / UYUP014103
Single Sided Maxi profile. Valet Frame Profile. 118.11", 0.59"x0.87".

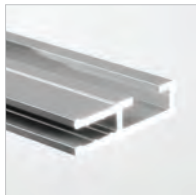

Profile / UYUP014105
Single Sided Maxi profile. Ace Frame Profile. 118.11", 1.26"x0.31".

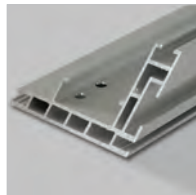

Profile
Aluminium profile for Power LED Maxi Frames.

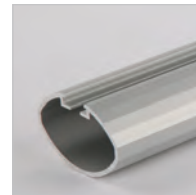

Profile
Aluminium profile for Omni Frame.



Profile
Wall Sign profile, 118.11".



Profile / UYUP014106
H profile for Maxi frames. 118.11", 1.42"x0.75".

For the packing details and minimum quantities please contact our sales executives.

| ARTICLE | LENGHT |
|------------|---------|
| UYPLPT1010 | 39.37" |
| UYPLPT1015 | 59.06" |
| UYPLPT1020 | 78.74" |
| UYPLPT1025 | 98.43" |
| UYPLPT1030 | 118.11" |
| UYPLPT1040 | 157.48" |
| UYPLPT1050 | 196.85" |
| UYPLPT1060 | 236.22" |

| ARTICLE | LENGHT |
|------------|--------|
| UYPOM00042 | 42" |
| UYPOM00062 | 62" |
| UYPOM00082 | 82" |
| UYPOM00122 | 122" |
| UYPOM00140 | 140" |
| UYPOM00182 | 182" |
| UYPOM00200 | 200" |

| ARTICLE | SIZE |
|------------|-------|
| UYUP021900 | 2.05" |
| UYUP021910 | 2.91" |
| UYUP021920 | 3.70" |
| UYUP021930 | 4.13" |
| UYUP021940 | 5.83" |

Semi Products



Corner / UYUP027000
Round corner with connector for 1.26" profile. Packed in 10.



Corner / UYUP028000
Round corner with connector for 1" profile. Packed in 10.



Corner / UYUP028500
Round corner with connector for 1.81" profile. Packed in 10.



Corner / UYUP027500
Round corner with connector for 1.02" profile. Packed in 10.



Corner / UYUP056000
Stretch frame plastic corner. Packed in 4.



Connector / UYUP024000
Corner connector of frames for 0.79"-1"-1.02". Packed in 10.



Corner / UYUP029000
Round corner with connector for 1.18" profile. Packed in 10.



Connector / UYUP025600
Corner connector of frames for 1.81". Packed in 10.



Connector / UYUP025400
Corner fittings for lightbox profile. Packed in 10.



Connector / UYUP445000
Free Standing unit connector for 1.18"/1.26" Frames & Poster Showboard. Packed in 20.



Connector / UYUP445100
Free Standing unit connector for 1" Frame. Packed in 20.



Connector / UYUP445200
Free Standing connector for Steel & Acrylic Shelf without support arm. Packed in 20.



Connector / UYUP445300
Free Standing connector for Noticeboard. Packed in 20.



Connector / UYUP371100
Single Banner connector. Packed in 10.



Connector / UYUP015000
Elips Profile connector for 2.01". Packed in 8.



Connector / UYUP016000
Elips Profile connector for 1.69". Packed in 4.



Connector / UYUP025000
Corner connector of frames for 1.18"-1.26"-1.65"-1.77". Packed in 10.



Connector / UYUP025200
Corner connector of frames for 0.59". Packed in 10.



Connector / UYUP412295
Corner Cleat for Maxi Frame. Packed in 8.



Connector / UYUP412291
Straight Cleat for H profile of Maxi Frame. Packed in 8.



Connector / UYUP412270
Square corner connector for Maxi frame. Packed in 10.



Connector / UYUP412310
Straight Cleat for H profile of Maxi Frame. Packed in 12.



Connector / UYUP412320
Connector for Ocean, Gulf, Lagoon and Bay Maxi frame profile. Packed in 10.



Connector / UYUP412330
Connector for Gulf Maxi frame profile. Packed in 10.



Connector / UYUP490000
Multiside & Cocktail Brochure set shelf connector. Packed in 10.

For the packing details and minimum quantities please contact our sales executives.

Semi Products



Connector / UYUP290240
Shelf support for Free Standing. Packed in 10.



Connector / UYUP062000
Quick Banner connector with screws. Packed in 20.



Connector / UYUP364000
Frame connector for Panset Wall System. Packed in 10.

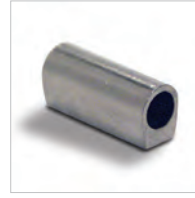

Connector / UYAA017500
Connector for Fishing line. Packed in 50.



Connector / UYAA017000
Connector for wire cable. Packed in 50.



Connector / UYAA012500
Top connector for single sided frame. Packed in 20.



Connector / UYAA012000
Bottom connector for single sided frame. Packed in 20.



Connector / UYUP450180
Side stopper for Pop-ups. Packed in 4.



Connector / UYUP025700
Corner connector of double sided slide-in frame. Packed in 10.



Connector / UYUP013000
T connector for 0.83" Elips Profile. Packed in 10.



Connector / UYUP014000
T connector for 1.69" Elips Profile. Packed in 10.



Connector / UYPOM02000
Connector Bracket for Omni Frame



Connector / UYPOM03000
T Connector for Omni Frame.



Connector / UYPOM06000
Profile Connector for Omni Frame.



Connector / UYPOM04000
Wall Fixing for Omni Frame.



Spring
Packed in 500.



Spring / UYUP450110
Spring for Pop-ups. Packed in 1 pcs.



End Cap / UYUP021200
End caps for Fast Note hole cover. Packed in 10.



End Cap / UYUP017000
End caps Elips profile for 2.01". Packed in 10.



End Cap / UYUP017500
End cap of Elips profile with channel. Packed in 10.

| ARTICLE | FOR |
|------------|----------------|
| UYUP110000 | 1.02" |
| UYUP030000 | 0.79" |
| UYUP031000 | 1" |
| UYUP032000 | 0.59" |
| UYUP032500 | 1.25" |
| UYUP032600 | 1.26"-Security |
| UYUP300000 | 1"-Security |
| UYUP310000 | 1.18" |
| UYUP350000 | 1.65" - 1.81" |
| UYUP361000 | 1.77" |

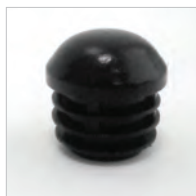

End Cap / UYUP019010
Steel pipe end cap Ø1". Packed in 10.



End Cap / UYUP018000
End caps Elips profile for 1.69". Packed in 10.



End Cap / UYUP019000
End caps for Rectangular. Packed in 10.



End Cap / UYUP012300
End caps for Free Standing Banner Set. Packed in 10.

For the packing details and minimum quantities please contact our sales executives.

Semi Products



End Cap / UYUP449600
Poster profile end cap for Poster Fast. Packed in 10.



End Cap / UYUP020000
End caps for Quick Banner. Packed in 10.



End Cap / UYUP021000
Poster Profile end cap for 1.02". Packed in 10.

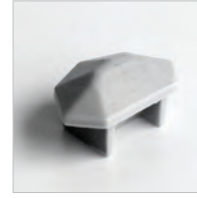

End Cap / UYUP021500
Rapid Brochure set end cap. Packed in 10.



End Cap / UYUP012200
End caps for Acrylic Side Shelf. Packed in 10.

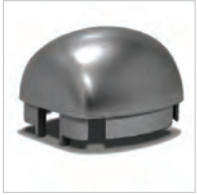

End Cap / UYUP019500
Plastic cap for Free Standing. Packed in 2.

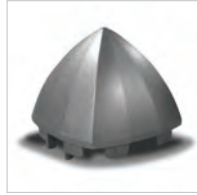

End Cap / UYUP019600
Plastic cap for Free Standing. Packed in 2.



End Cap / UYUP019400
Plastic cap for Novel Free Standing. Packed in 2.



End Cap / UYUP021400
End caps for Newage Poster Clamp. Packed in 10.



End Cap / UYUP021100
End caps for Fast Note. Packed in 10.



End Cap
Wall Sign Arc end caps Packed in 10.



End Cap
Wall Sign Flat end caps Packed in 10.



Hanger / UYAA018000
Hanger for 0.35" Frameboard. Packed in 10.



Hanger / UYAA011000
Metal hanger for Frame & Poster Snap. Packed in 10.



Hanger / UYAA011010
Metal portable hanger for Frame. Packed in 10.

| ARTICLE | SIZE |
|------------|-------|
| UYUP021800 | 2.05" |
| UYUP021810 | 2.91" |
| UYUP021820 | 4.13" |
| UYUP021840 | 3.70" |

| ARTICLE | SIZE |
|------------|-------|
| UYUP021700 | 2.05" |
| UYUP021710 | 2.91" |
| UYUP021720 | 4.13" |
| UYUP021730 | 5.83" |
| UYUP021740 | 3.70" |



Hanger / UYAA023000
Poster Gripper Hanger set. Packed in 10.



Hanger / UYUP055000
Plastic hanger for Stretch Frame. Packed in 10.



Hanger / UYUP075000
Poster Snap hanger. Packed in 10.



Hanger / UYUP076010
Newage Poster Clamp hanger. Packed in 10.



Hanger / UYUP076000
Poster Clamp hanger. Packed in 10.



Hanger / UYAA021000
Hanger for slide-in frame & poster fast set. Packed in 10.



Hanger / UYAA010000
Pipe&Clamp connector for double sided Smart Banner. Packed in 5.



Hanger / UYAA009000
Pipe&Clamp connector for single sided Smart Banner. Packed in 5.



Hanger / UYAA008000
Pipe&Clamp connector for single sided Quick Banner. Packed in 5.



Hanger / UYUP450130
Magnetic body connector with magnets for magnetic Pop-up. Packed in 2.

For the packing details and minimum quantities please contact our sales executives.



Hanger / UYUP450140
Mechanic body connector with panel hanger for Pop-up with clips. Packed in 2.



Hanger / UYUP450150
Magnetic end cap for aluminium profile for magnetic Pop-up. Packed in 10.



Hanger / UYUP450160
Mechanic end cap for aluminium profile for Pop-up with clips. Packed in 10.



Hanger / UYUP450065
Clips bar with magnetic tape.



Hanger / UYUP450075
Magnet bar with magnetic tape.



Hanger
Top&bottom straps set for Pop-up with clips.

| ARTICLE | FOR |
|------------|-----|
| UYUP450000 | 3X3 |
| UYUP450010 | 3X4 |



Hanger
Top&bottom straps set for magnetic Pop-up.

| ARTICLE | FOR |
|------------|-----|
| UYUP450020 | 3X3 |
| UYUP450030 | 3X4 |



Hanger / UYUP460245
Hanging system for Lagoon Maxi Frame including wire cable. Packed in 8.



Pipes / UYUP061100
Telescopic pipe for double sided Smart Roll Banner.



Pipes / UYUP061000
Telescopic pipe for single sided Smart Roll Banner.



Pipes / UYUP053000
7.87"



Pole / UYUP052000
7.87" Quick pipe in 3 part.



Feet / UYUP366000
Panset foot at the bottom for Panset Wall System. Packed in 10.



Feet / UYUP023000
Plastic foot for Quick Banner. Packed in 10.



Feet / UYUP022000
Base for Quick Banner. Packed in 10.



Feet / UYUP412273
Baseball 17.72"x11.81"x0.24" for double sided king profile.

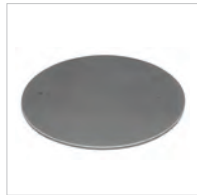

Feet / UYUP412271
Circle Ø17.72"x0.24" for double sided king profile.



Feet / UYUP412272
Hoop Ø17.72"x0.24" for double sided king profile.



Feet / UYUP412274
Fillet 19.69"x7.09"x0.24" for double sided king profile.



Feet / UYUP412275
Flat 15.75"x19.70"x0.20" for double sided king profile.



Counter Support / UYUP460200
For 8.5"x11" Opti Frame. Packed in 10.



Counter Support / UYUP460100
For 5.5"x8.5" Opti Frame. Packed in 10.



Counter Support / UYUP460000
For 4"x6" Opti Frame. Packed in 10.



Counter Support / UYUP057000
U wire for Snap Frames.



Logo / UYUP407400
Rapid brochure set frosted logo.

For the packing details and minimum quantities please contact our sales executives.

Semi Products



Logo / UYUP407500
Rapid brochure set clear logo.

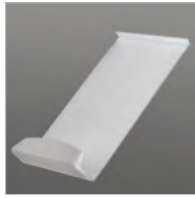

Shelf / UYR0007000
Rapid brochure set frosted shelf.

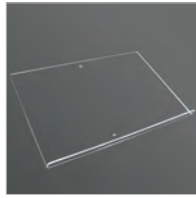

Shelf / UYR0008000
Folder menuboard clear acrylic shelf without ring.



Shelf
8.5"X11" shelf with connector.

| ARTICLE | PACKED IN |
|------------|-----------|
| UMSDA005A4 | 5 |
| UMSDA008A4 | 8 |



Shelf / UYUP073101
8.5"x11" shelf for Portable Leaflet Dispensers. Packed in 8.



Shelf / UYUP073103
6.5"x8" shelf for Portable Leaflet Dispensers. Packed in 8.



Shelf / UYUP073102
4"x9" shelf for Portable Leaflet Dispensers. Packed in 8.



Panel
Opal acrylic

| ARTICLE | SIZE | DESCRIPTION |
|------------|-----------|-----------------|
| UYUP407251 | 22" X 28" | Convex Lightbox |
| UYUP407270 | 20" X 30" | Convex Lightbox |
| UYUP407280 | 30" X 40" | Convex Lightbox |
| UYUP407121 | 27" X 67" | Totem |
| UYUP407131 | 27" X 77" | Totem |



Panel
Anti-reflex PET Cover for Swing Master & Eco Swing Master

| ARTICLE | SIZE | PET |
|------------|-----------|-----------------|
| UYUP088250 | 20" X 30" | 21.14" X 31.14" |
| UYUP088260 | 30" X 40" | 31.14" X 41.14" |
| UYUP088270 | 40" X 60" | 41.14" X 61.14" |



Panel
Anti-reflex PET Cover for Waterproof Snap frame 25 mm.

| ARTICLE | SIZE | PET |
|------------|-----------|-----------------|
| UYUP088441 | 18" X 24" | 19.30" X 25.30" |
| UYUP088442 | 22" X 28" | 23.30" X 29.30" |
| UYUP088443 | 24" X 36" | 25.30" X 37.30" |

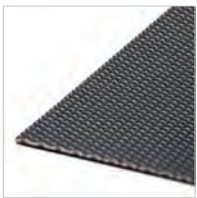

Panel
Polystyrene Backing.

| ARTICLE | SIZE |
|------------|------------|
| UYUP093002 | 5" X 7" |
| UYUP093003 | 6" X 9" |
| UYUP093004 | 8" X 10" |
| UYUP093001 | 8.5" X 11" |
| UYUP094001 | 11" X 14" |
| UYUP094002 | 11" X 17" |
| UYUP094003 | 14" X 22" |
| UYUP095001 | 16" X 20" |
| UYUP095002 | 18" X 24" |
| UYUP097001 | 20" X 30" |
| UYUP044001 | 22" X 28" |
| UYUP044002 | 24" X 36" |
| UYUP096001 | 27" X 40" |
| UYUP099000 | 30" X 40" |
| UYUP100000 | 40" X 60" |



Panel
Anti-reflex PET Cover.

| ARTICLE | SIZE |
|------------|------------|
| UYUP081001 | 5" X 7" |
| UYUP082001 | 6" X 9" |
| UYUP083002 | 8" X 10" |
| UYUP083001 | 8.5" X 11" |
| UYUP084002 | 11" X 14" |
| UYUP084001 | 11" X 17" |
| UYUP084003 | 14" X 22" |
| UYUP084004 | 16" X 20" |
| UYUP088100 | 18" X 24" |
| UYUP090000 | 20" X 30" |
| UYUP088100 | 22" X 28" |
| UYUP088101 | 24" X 36" |
| UYUP088102 | 27" X 40" |
| UYUP091000 | 30" X 40" |
| UYUP092000 | 40" X 60" |



Panel
Anti-reflex PET Cover for Waterproof Snap frame 35 mm.

| ARTICLE | SIZE | PET |
|------------|------------|-----------------|
| UYUP081001 | 5" X 7" | 6.73" X 8.73" |
| UYUP082001 | 6" X 9" | 7.73" X 10.73" |
| UYUP083002 | 8" X 10" | 9.73" X 11.73" |
| UYUP083001 | 8.5" X 11" | 10.23" X 12.73" |
| UYUP084002 | 11" X 14" | 12.73" X 15.73" |
| UYUP084001 | 11" X 17" | 12.73" X 18.73" |
| UYUP084003 | 14" X 22" | 15.73" X 23.73" |
| UYUP084004 | 16" X 20" | 17.73" X 21.73" |
| UYUP088100 | 18" X 24" | 19.73" X 25.73" |
| UYUP090000 | 20" X 30" | 21.73" X 31.73" |
| UYUP088100 | 22" X 28" | 23.73" X 29.73" |
| UYUP088101 | 24" X 36" | 25.73" X 37.73" |
| UYUP088102 | 27" X 40" | 28.73" X 41.73" |
| UYUP091000 | 30" X 40" | 31.73" X 41.73" |
| UYUP092000 | 40" X 60" | 41.73" X 61.73" |



Panel
Magnetic & Magneco LEDbox cover.

| ARTICLE | SIZE |
|------------|-----------|
| UYPML10017 | 11" X 17" |
| UYPML10024 | 18" X 24" |
| UYPML10023 | 20" X 30" |
| UYPML10022 | 22" X 28" |
| UYPML10024 | 24" X 36" |
| UYPML10034 | 30" X 40" |



Panel
PVC panel complete for Pop-up table.

| ARTICLE | FOR |
|------------|-----|
| UYUP450040 | 3x3 |
| UYUP450050 | 3x4 |

For the packing details and minimum quantities please contact our sales executives.

Semi Products



Power Supply
Power supply for Ledbox.
Daily use 16h.

| ARTICLE | DESCRIPTION |
|------------|--------------------|
| UYUP445441 | Power supply US 1A |
| UYUP445450 | Power supply EU 2A |
| UYUP445451 | Power supply US 2A |
| UYUP445452 | Power supply UK 2A |
| UYUP445460 | Power supply EU 3A |
| UYUP445461 | Power supply US 3A |
| UYUP445462 | Power supply UK 3A |
| UYUP445490 | Power supply EU 4A |
| UYUP445491 | Power supply US 4A |
| UYUP445492 | Power supply UK 4A |
| UYUP445510 | Power supply EU 5A |
| UYUP445511 | Power supply US 5A |
| UYUP445512 | Power supply UK 5A |
| UYUP445520 | Power supply EU 6A |
| UYUP445521 | Power supply US 6A |
| UYUP445522 | Power supply UK 6A |



Power Supply
Power supply for Weatherproof
Ledbox. Daily use 16h.

| ARTICLE | DESCRIPTION |
|------------|--|
| UYPLD0103A | Power supply EU 3A for Weatherproof LEDbox |
| UYPLD0303A | Power supply US 3A for Weatherproof LEDbox |
| UYPLD0203A | Power supply UK 3A for Weatherproof LEDbox |
| UYPLD0104A | Power supply EU 4A for Weatherproof LEDbox |
| UYPLD0304A | Power supply US 4A for Weatherproof LEDbox |
| UYPLD0204A | Power supply UK 4A for Weatherproof LEDbox |
| UYPLD0105A | Power supply EU 5A for Weatherproof LEDbox |
| UYPLD0305A | Power supply US 5A for Weatherproof LEDbox |
| UYPLD0205A | Power supply UK 5A for Weatherproof LEDbox |
| UYPLD0106A | Power supply EU 6A for Weatherproof LEDbox |
| UYPLD0306A | Power supply US 6A for Weatherproof LEDbox |
| UYPLD0206A | Power supply UK 6A for Weatherproof LEDbox |



Power Supply
Power supply for Ledbox.
Daily use 24h.

| ARTICLE | DESCRIPTION |
|------------|-------------------------------------|
| UYPLD00010 | Power supply EU 3,34A 7/24 suitable |
| UYPLD02010 | Power supply US 3,34A 7/24 suitable |
| UYPLD01010 | Power supply UK 3,34A 7/24 suitable |
| UYPLD00011 | Power supply EU 6,67A 7/24 suitable |
| UYPLD02011 | Power supply US 6,67A 7/24 suitable |
| UYPLD01011 | Power supply UK 6,67A 7/24 suitable |
| UYPLD00012 | Power supply EU 8,5A 7/24 suitable |
| UYPLD02012 | Power supply US 8,5A 7/24 suitable |
| UYPLD01012 | Power supply UK 8,5A 7/24 suitable |
| UYPLD00013 | Power supply EU 11,5A 7/24 suitable |
| UYPLD02013 | Power supply US 11,5A 7/24 suitable |
| UYPLD01013 | Power supply UK 11,5A 7/24 suitable |



Power Supply / UYPSWL0020
Charger for WindPro with LED.



Power Supply / UYPSWL0010
Spare Battery for WindPro
with LED.



Base
Waterbase Wind Sign base.

| ARTICLE | DESCRIPTION |
|------------|-------------|
| UYUP406820 | Small base |
| UYUP406810 | Medium Base |
| UYUP406840 | Large Base |



Other / UYUP445600
Black foam tape for
Poster Snap.

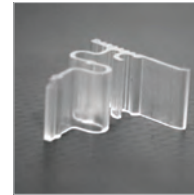

Other / UYUP410300
Plastic Peg for Showboard.
Packed in 10.



Other / UYUP360110
Screw and Wall Plug
for Snap Frames.
Packed in 10.



Other / UYUP406410
Wheel and its fixture for
Waterbase.



Other / UYUP460220
Nylon strip with double
sided tape. 164 ft.



Other / UYUP449500
Plastic part in 1.57" for
Poster Fast. Packed in 10.



Other / UYUP021300
Roller for Fast Note.
Packed in 50.



Other / UYUP368100
Hinge for A Board.
Packed in 10.



Other / UYUP080000
Scissors for A Board.
Packed in 10.



Other / UYUP444000
Wheel for stands.
Packed in 1.



Other / UYUP290200
Fixing hardware for Free Standing
Leaflet Display. Packed in 10.



Other / UYUP480510
Top plate of Pop-up table.

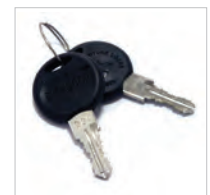

Other / UYUP427510
Key D20 for Showboards &
Noticeboards. Packed in 10.

For the packing details and minimum quantities please contact our sales executives.

Semi Products



Other / UYUP427520
Key for Universal Showboards. Single packed.



Other / UYUP427500
Lock for Showboards. Packed in 1.



Other / UYUP450120
Light hanger for Pop-ups. Packed in 5.



Other / UYUP450170
Spring holder fork for Pop-ups. Packed in 10.



Other / TSH4010S01
Black Bungee Cord with Stainless Steel Hook for Omni Frame.



Other / UYPOM05000
Plastic Button for Omni Frame.



Other / TMC4010S00
Plastic Clips for Omni Frame.



Other / UYPOM07000
Plastic Strap for Omni Frame.



Other / UYUP450100
Magnetic tape roll in 98 ft.



Other / UYAA004500
Fishing Line.



Other / UYUP460235
Clear nylon strip. 328 ft.



Other / UYUP365000
Cleat for Panset Wall System. Packed in 10.



Plastic Extrusion Lines

- PET Lines
- PVC Foam Lines
- Neo PVC Foam Lines
- Plasteco PVC Foam Lines
- HIPS Lines



PET Extrusion Lines



The PET line composes of one main extruder 75 dia. and one co-extruder dia. 45. It is a Battenfeld machine with a capacity of 1433 lbs/h as from 300 microns to 1500 microns. The surface options are matt/gloss and gloss/gloss. Transparent & colored alternatives are available. The maximum width is 55.12". PET sheet line is integrated with very accurate Maxson sheet sizing unit. In addition to this, a 1 ton and 0.04" diameter capacity roll winder and an 8 pieces slitter in a standalone form wind and slit the sheets for the packaging industry. This machinery is fed by a fully automatic crystallizer and a dry air drier by Colortronic-Germany. A lot of alternative polymer sheets with antiblock-antislip agents, a UV stabilizer and optical brightener additives are available. The PET line with cold lamination units on both sides protects the film application while serving hot lamination for different sheet extrusion alternatives. For color options, please contact our sales department.



Composition:

PET is an abbreviation of Polyethylene Terephthalate. Chemical composition is $(C_{10}H_8O_4)_n$

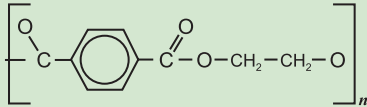

Application Areas : Signs. Food Packaging. Vacuum forming. Printing. Stationary. POS stands. White Goods Equipments. Construction Equipments.

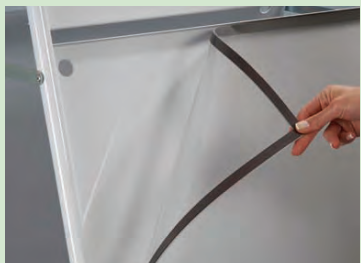

Operating Processes

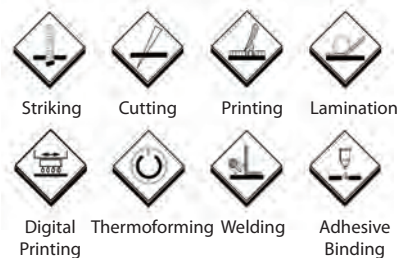

PET Delivery Programme

Special Requirements on Request

- MOQ: 1 pallet/article
- Each pallet max. 1 ton
- Custom sizes and colours available (subjected to MOQ)
- UV, corona or silicon treatments available (subjected to MOQ)
- Film surcharge €0.20/m² one one side, €0.40/m² on both sides.
- Available on reels



Rev. 01 - 27.03.2014

Production By Order - Transparent&White

| Thickness | Sheet Size | | | Surface | | Sheet / Pallet | | | Sheet / Pack | | |
|-----------|------------|---|--|---|------|----------------|---|--|---|---|--|
| | inch | 3'3 ³ / ₈ " x 4'1 ¹ / ₈ " | 4'1 ⁷ / ₃₂ " x 6'8 ⁴⁵ / ₆₄ " | 4'1 ¹ / ₈ " x 9'10 ⁷ / ₁₆ " | Matt | Gloss | 3'3 ³ / ₈ " x 4'1 ¹ / ₈ " | 4'1 ⁷ / ₃₂ " x 6'8 ⁴⁵ / ₆₄ " | 4'1 ¹ / ₈ " x 9'10 ⁷ / ₁₆ " | 3'3 ³ / ₈ " x 4'1 ¹ / ₈ " | 4'1 ⁷ / ₃₂ " x 6'8 ⁴⁵ / ₆₄ " |
| 0.011" | ✓ | ✓ | n/a | ✓ | ✓ | 2000 | 1000 | n/a | 100 | 50 | n/a |
| 0.015" | ✓ | ✓ | ✓ | ✓ | ✓ | 1400 | 700 | 400 | 100 | 50 | 20 |
| 0.019" | ✓ | ✓ | ✓ | ✓ | ✓ | 1000 | 600 | 350 | 50 | 50 | n/a |
| 0.023" | ✓ | ✓ | ✓ | ✓ | ✓ | 900 | 500 | 300 | 50 | 30 | 20 |
| 0.027" | ✓ | ✓ | ✓ | ✓ | ✓ | 750 | 450 | 250 | 50 | 30 | 20 |
| 0.030" | ✓ | ✓ | ✓ | ✓ | ✓ | 750 | 450 | 250 | 50 | 30 | 20 |
| 0.040" | ✓ | ✓ | ✓ | ✓ | ✓ | 540 | 300 | 180 | 50 | 30 | 20 |
| 0.060" | ✓ | ✓ | n/a | ✓ | ✓ | 350 | 200 | 100 | 30 | 20 | n/a |

PET Sheet Tolerances

| Tolerance in Thickness | | Rectangularity | Off Line Cutting Widht & Length Tolerances | On Line Cutting Widht & Length Tolerances | Number Of Sheet Tolerance On A Pack |
|------------------------|---------------|---|--|---|-------------------------------------|
| 0.01" - 0.02" inch | max ±20micron | Rectangularity off line cutting max ±0.04" inch | max ±0.08" inch in length | max ±0.16" inch in length | max ±%2 sheets |
| 0.03" - 0.04" inch | max ±25micron | Rectangularity on line cutting max ±0.08" inch | max ±0.04" inch in width | max ±0.08" inch in width | |
| 0.04" - 0.06" inch | max ±30micron | | | | |

Test Reports

| Test | Dimension | Standard | Value |
|--|----------------------|--|---------------|
| Density | g/cm ³ | DIN EN ISO 1183 | 1,34 |
| Modulus of elasticity (tensile) | Mpa | DIN EN ISO 527-3, 1B/50, 0.03"/min till 5 Mpa, in direction of production | 2460 |
| Tensile stress at yield | Mpa | DIN EN ISO 527-3, 1B/50, 0.03"/min till 5 Mpa, in direction of production | 41,5 |
| Elongation at yield | % | DIN EN ISO 527-3, 1B/50, 0.03"/min till 5 Mpa, in direction of production | 2,3 |
| Breaking strength (20 °C) | MPa | DIN EN ISO 527-3, 1B/50 in direction of production | 31,8 |
| Elongation at break | % | DIN EN ISO 527-3, 1B/50 in direction of production | 15,3 |
| Modulus of elasticity (flexion) | MPa | DIN EN ISO 178, 0.07"/min till 1,5%, then 0.39"/min | 2250 |
| Flexural strength at 3.5 % flexion | MPa | DIN EN ISO 178, 0.07"/min till 1,5%, then 0.39"/min | 61,5 |
| Flexural strength , maximum | MPa | DIN EN ISO 178, 0.07"/min till 1,5%, then 0.39"/min | 64,8 |
| Impact strength at +23 °C | KJ/m ² | DIN EN ISO 179-1/1eU, in direction of production, support distance 2.44", 4 Joule Hammer | 89,7 |
| Impact strength notched at +23 °C | KJ/m ² | DIN EN ISO 179-1/1eU, in direction of production, support distance 2.44", 0,54 Joule Hammer and 1 Joule hammer (ABS) | 21,6 |
| Vicat softening point | KJ/m ² | DIN EN ISO 306, 50 K/h, load 50 N, procedure B | 95 |
| Water vapor permeability | g/(m ² d) | DIN EN ISO 15106-3 at 23 °C, 85% to 0% relative humidity | 3,32 |
| Glass transition temperature | °C | DIN EN ISO 11357-2 at 20 K/min | 1,1 and 107,2 |
| Melting temperature (Peak) | °C | DIN EN ISO 11357-3 at 20 K/min | ---2) |
| Crystallization temperature | °C | DIN EN ISO 11357-3 at 20 K/min | ---2) |
| Shore D hardness | - | DIN 53505 | 80 |
| Lineer coefficient of thermal expansion (23-80 °C) | 10-5 1/K | ISO 11359-2, procedure B, 5 K/min in direction of production | 9,7 |

Available From Stock - Transparent

| Thickness inch | 49 1/4" x 80 3/4" | | 55 1/8" x 118 1/8" | |
|----------------|-------------------|-------------|--------------------|-------------|
| | mat/gloss | gloss/gloss | mat/gloss | gloss/gloss |
| 0.011" | n/a | DS FILM | n/a | n/a |
| 0.019" | n/a | DS FILM | NO FILM | n/a |
| 0.027" | n/a | DS FILM | n/a | n/a |
| 0.029" | SS FILM | DS FILM | n/a | n/a |
| 0.039" | SS FILM | DS FILM | SS FILM | DS FILM |
| 0.059" | SS FILM | DS FILM | n/a | n/a |

* DS FILM: Available as both side protected with film

* SS FILM: Available as gloss side protected with film

* NO FILM: Available as without film

Fire Classification

| Country | Standard | Rating | Thickness | Colour |
|---------|--------------------|--------------|------------|-------------|
| Germany | DIN EN ISO 11925-2 | B2 (Indoors) | 0.04" inch | Transparent |
| | DIN EN 13823 | | | |

PVC Foam Extrusion Lines

4 extrusion lines; one from Cincinati and 3 from Krauss Maffei. PVC Foam Extrusion Line has two parts which produce sheets from 0.04" to 0.75" thickness and from 48.03" to 80.71" width. The first part is AZO dozing unit which prepares PVC blend with different formulas. The second part is the line producing PVC foam sheets with different die widths and different thicknesses. The line also disposes of a movable saw cutting the sheets.

It has 3 dies;

| die | Width inch | Lips | Lips Thickness |
|-----|------------|------|-------------------------------|
| 1 | 80 3/4" | 2 | 0.04" - 0.20" |
| 2 | 61 7/16" | 3 | 0.04" - 0.24" / 0.24" - 0.75" |
| 3 | 48 1/16" | 3 | 0.04" - 0.24" / 0.24" - 0.39" |

Each line has 1984 lbs / hour capacity.

All the lines have the ability of covering protection film on both sides one side of PVC Foam with cold lamination units.

Composition:
Vinyl chloride.

PVC  Plovinil Klorür -0, + 60 C

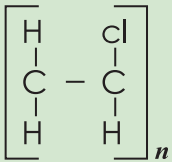

Application Areas : Signs, Digital Printing, Printing, Construction Industry, Shop Fittings, Health Sector, Furniture Sector, Sandwich Panels, Wall Coverings.

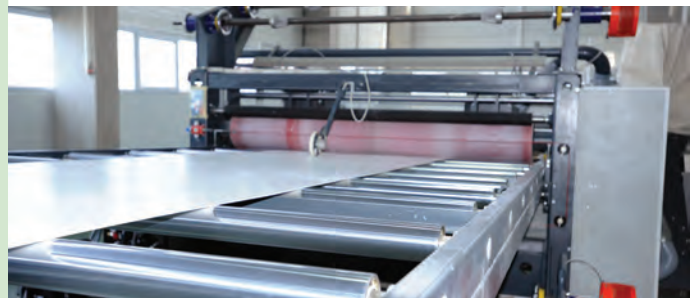
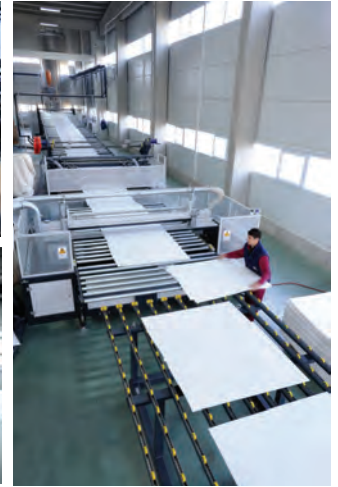

Operating Processes



PVC Foam Delivery Programme

Protective Film

- PE film on one side as standard
- No branding over the film
- Digital marking of sizes over on long side

Tolerance Fixed For Each Thickness

- -0 to + 0.08" on width
- -0 to + 0.39" on length
- Rectangularity is max. 0.08" per meter

Tolerance in Thickness

- +/- 0.006" for 0.04"-0.08" thickness
- +/- 0.006" for 0.12"-0.24" thickness
- +/- 0.012" for 0.31"-0.39" thickness
- +/- 0.020" for 0.59"-0.75" thickness

*Tolerances are measured for on-line cutting

Special Requirements On Request

- Additional thicknesses as required
- Non standard sheet dimensions are available
- Protective PE film on both sides as required, surcharge +0.20 € / m²
- Cut sheet available on-line



Rev. 09 - 01.01.2016

PVC Foam Colour White

| Thickness inch | 5' 1 ¹ / ₂ ' x 10' | 6' 8 ⁴⁵ / ₆₄ ' |
|----------------|--|--------------------------------------|
| 0.04" | ✓ | ✓ |
| 0.08" | ✓ | ✓ |
| 0.12" | ✓ | ✓ |
| 0.16" | ✓ | ✓ |
| 0.20" | | ✓ |
| 0.24" | ✓ | ✓ |
| 0.31" | ✓ | ✓ |
| 0.39" | ✓ | ✓ |
| 0.59" | ✓ | |
| 0.75" | ✓ | |

* 0.59" and 0.75" are available only from stock, are not produced on order.

** 0.08" available by order with a lead time of 6-12 weeks.

*** Other thicknesses are produced on order (subject to moq).

Palet Quantities For Only Truck Deliveries

| Thickness inch | 5' 1 ¹ / ₂ ' x 10' | 6' 8 ⁴⁵ / ₆₄ ' |
|----------------|--|--------------------------------------|
| 0.04" | 250 | 200 |
| 0.08" | 200 | 150 |
| 0.12" | 120 | 100 |
| 0.16" | 100 | 80 |
| 0.20" | 80 | 60 |
| 0.24" | 60 | 60 |
| 0.31" | 50 | 40 |
| 0.39" | 40 | 40 |
| 0.59" | 30 | |
| 0.75" | 25 | |



Physical Properties Of PVC Foam

| Test | Test Method | Units | Average Result |
|-----------------------------------|------------------|-------------------|----------------|
| Specific Gravity | In-House | g/cm ³ | 0.50-0.70 |
| Determination of Water Absorption | ISO 62: Method 1 | % | 0.19 |
| Tensile Strength at Yield | ISO R527 | MPa | 19.37 |
| Elongation at Break | ISO R527 | % | 17.89 |
| Flexural Modulus | ISO 176 | GPa | 0.903 |
| Charpy Impact Strength | ISO 179 | kJm ⁻² | 1.43 |
| Shore D Hardness | ISO 868 | for 1-6 Value | 40-47 |
| | | for 8-10 Value | 40-47 |
| Heat Distortion Temperature | ISO 75: Method A | °C | 57.75 |
| | ISO 75: Method B | °C | 68.4 |
| Coefficient of Linear Expansion | In-House | ° ⁻¹ C | 0.498x10.6 |

Fire Classification

| Test | Test Method | Units | Average Result |
|-----------------------------------|-------------|-------|----------------|
| Fire classification 0.12" & 0.20" | EN 13501-1 | Class | C - s3, d1 |

Colour Red Available in Stock

| Thickness inch | 5' 1 ¹ / ₂ ' x 10' |
|----------------|--|
| 0.12" | ✓ |
| 0.20" | ✓ |

Colour Black Available in Stock

| Thickness inch | 5' 1 ¹ / ₂ ' x 10' |
|----------------|--|
| 0.12" | ✓ |
| 0.20" | ✓ |



PVC Foam Extrusion Lines

- Improved Whiteness.
- Suitable for direct printing.
- Single side protective film.
- 48 1/6" x 80 3/4" standard sheet dimension.
- 0.12" / 0.20" / 0.39" thickness available.
- Low Density.
- Best priced bright white printable PVC Foam .

Physical Properties of PVC Foam

| Test | Test Method | Units | Average Result |
|-----------------------------------|-----------------------|-------------------|----------------|
| Specific Gravity | In-House | g/cm3 | 0,45 |
| Determination of Water Absorption | TS ISO 62:Method 1 | % | 0.20 |
| Tensile Strength at Yield | TS EN ISO527-1, 527-2 | MPa | 10,54 - 11,13 |
| Elongation at Break | TS EN ISO527-1, 527-2 | % | 10 - 14 |
| Heat Distortion Temperature | ISO 179-1 Method A | C° | 59°C |
| | ISO 179-1 Method B | C° | 65°C |
| Charpy Impact Strength | TS ISO 179-1 | kJ/m ² | 9,3 |
| Shore D Hardness | ISO 868 | for 0.12" | 33 - 34 |
| | ISO 868 | for 0.20" | 35 - 36 |

Pallet Quantities for Only Truck Deliveries

| Thickness inch | 48 1/6" x 88 1/4" | 48 1/6" x 120 1/8" | 61 7/16" x 120 1/8" | 80 3/4" x 120 1/8" |
|----------------|-------------------|--------------------|---------------------|--------------------|
| 0.08" | 200 | 200 | 200 | 150 |
| 0.12" | 150 | 150 | 140 | 120 |
| 0.16" | 140 | 140 | 120 | 100 |
| 0.20" | 120 | 120 | 100 | 80 |
| 0.24" | 80 | 80 | - | 70 |
| 0.31" | 60 | 60 | 60 | 50 |
| 0.39" | 50 | 50 | 50 | 40 |

NEO PVC Foam Colour White

| Thickness mm | 48 1/6" x 88 1/4" | 48 1/6" x 120 1/8" | 61 7/16" x 120 1/8" | 80 3/4" x 120 1/8" |
|--------------|-------------------|--------------------|---------------------|--------------------|
| 2 | ✓ | ✓ | ✓ | ✓ |
| 3 | ✓ | ✓ | ✓ | ✓ |
| 4 | - | - | ✓ | ✓ |
| 5 | ✓ | ✓ | ✓ | ✓ |
| 6 | - | - | - | ✓ |
| 8 | ✓ | ✓ | ✓ | ✓ |
| 10 | ✓ | ✓ | ✓ | ✓ |

Fire Classification

| Test | Test Method | Units | Average Result |
|---------------------------|-------------|-------|----------------|
| Fire classification 3mm | EN 11925-2 | Class | C - s2, d0 |
| Fire classification 5mm | EN 11925-2 | Class | C - s3, d0 |
| Fire classification 10 mm | EN 11925-2 | Class | C - s3, d0 |

Application Areas : Signs, Digital Printing, Printing, Construction Industry, Shop Fittings, Health Sector, Furniture Sector, Sandwich Panels, Wall Coverings.



Operating Processes



PLASTEKO

PVC Foam Extrusion Lines

- White
- Suitable for lamination, letter cutting and similar application.
- Single side non-branded protective film.
- 61^{7/16}"x120^{1/8}", 80^{3/4}" x 120^{1/8}" standard sheet dimension.
- 0.10" / 0.12" / 0.18" / 0.20" / 0.35" thickness available.
- Low Density, 0,40gr/m3
- Best price

Pallet Quantities for Only Truck Deliveries

| Thickness inch | 61 ^{7/16} "x120 ^{1/8} " | 80 ^{3/4} "x120 ^{1/8} " |
|----------------|---|--|
| 0.10" | 175 | 150 |
| 0.12" | 140 | 120 |
| 0.18" | 120 | 100 |
| 0.20" | 100 | 80 |
| 0.35" | 60 | 50 |

PLASTEKO PVC Foam Colour White

| Thickness inch | 61 ^{7/16} "x120 ^{1/8} " | 80 ^{3/4} "x120 ^{1/8} " |
|----------------|---|--|
| 0.10" | ✓ | ✓ |
| 0.12" | ✓ | ✓ |
| 0.18" | ✓ | ✓ |
| 0.20" | ✓ | ✓ |
| 0.35" | ✓ | ✓ |

With or without protection film.



Application Areas : Signs, Digital Printing, Printing, Construction Industry, Shop Fittings, Health Sector, Furniture Sector, Sandwich Panels, Wall Coverings.

Operating Processes



HIPS

Extrusion Lines

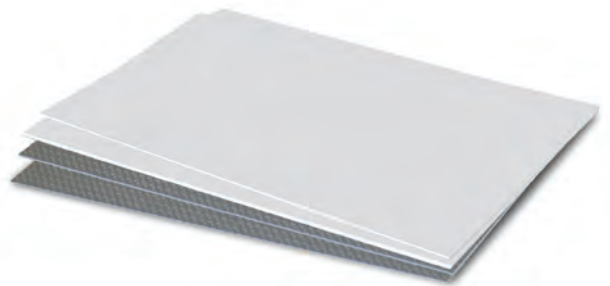

HIPS Line is available to produce one, two, three or five layers HIPS, ABS and ABS+PMMA sheets from 0.04" to 0.24" thicknesses so different colors and with different additives. It is a Battenfeld machine. Although this line has a movable guillotine to cut the sheets according to customers' needs, the precise final cut is still conducted by a supplementary INPRO sheeter. This line is also fed by Colortronic driers and dosing equipments.

| | Minimum | Maximum |
|-----------|---------|---------|
| Thickness | 0.04" | 0.24" |
| Width | 19.69" | 80.71" |
| Length | 19.69" | 236.22" |

For special sizes and tolerances of up to 0.03" sheets can be ordered.

| HIPS Sheet | | | | | | |
|------------|---|---|------------------------|----------------|---------------------|----------------|
| Thickness | Sheet Sizes | | | Colour | Surface | Sheet quantity |
| inch | 3' 3 ^{3/8} " x 4' 1 ^{1/8} " | 4' 1 ^{7/32} " x 6' 8 ^{5/16} " | 6' 8 ^{5/16} " | White and Grey | Embossed and Smooth | per pallet |
| 0.03" | x | x | x | | | 900/500/200 |
| 0.04" | x | x | x | | | 700/350/150 |
| 0.06" | x | x | x | | | 450/250/100 |
| 0.08" | x | x | x | | | 350/185/75 |
| 0.12" | | x | x | | 225/125/50 | |

The information and recommendations in this brochure are accurate and reliable to the best of our knowledge, however users should perform their own tests to determine the suitability of these products for their own particular purposes.

Composition:

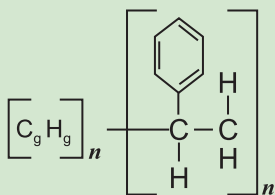

HIPS High impact polystyrene -5, + 80 C

Application Areas : Signs, White Goods Equipments (Refrigerator Interiors), Sanitary Sector (Shower Doors), Packaging, Electrical components, Toy components, Furniture Sector, Interior dividing panels.



Operating Processes

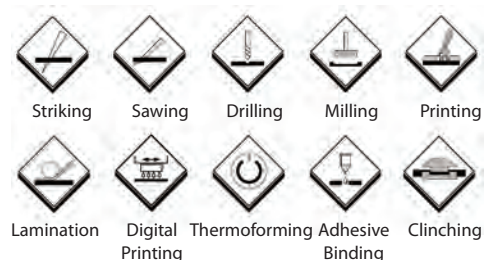

Symbols

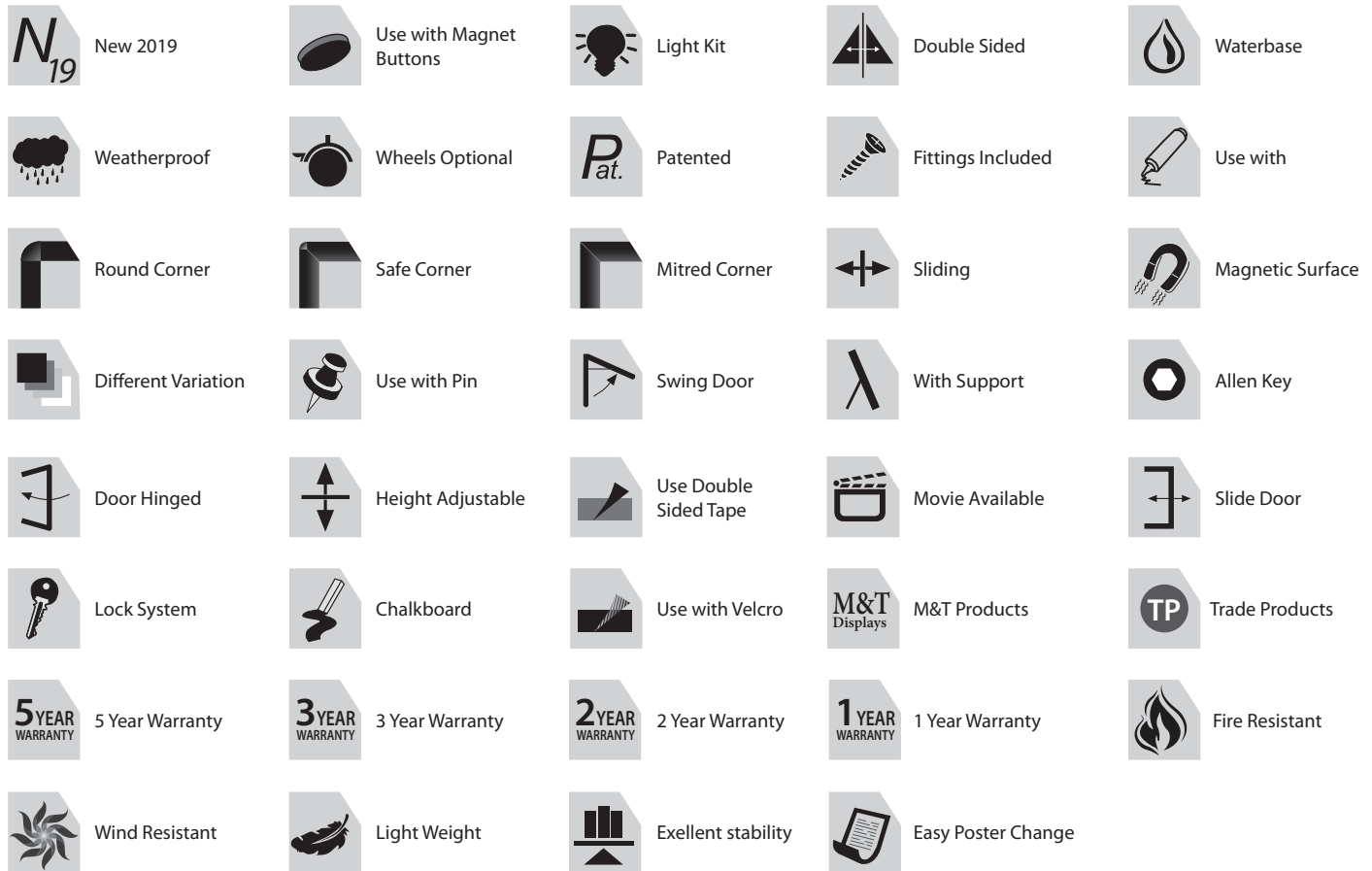

Standard RAL references available

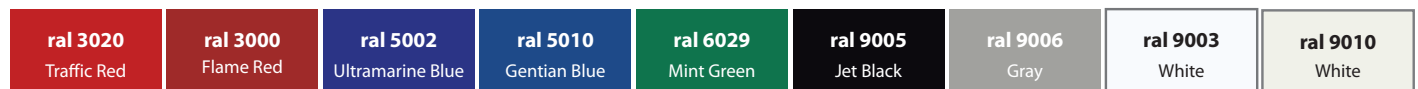

RAL Colours available with MOQ

| | | | | | | | | | | | | | | | |
|----------|----------|----------|----------|----------|----------|----------|----------|----------|----------|----------|----------|----------|----------|----------|----------|
| ral 1000 | ral 1001 | ral 1002 | ral 1003 | ral 1004 | ral 1005 | ral 1006 | ral 1007 | ral 1011 | ral 1012 | ral 1013 | ral 1014 | ral 1015 | ral 1016 | ral 1017 | ral 1018 |
| ral 1019 | ral 1020 | ral 1021 | ral 1023 | ral 1024 | ral 1027 | ral 1028 | ral 1032 | ral 1033 | ral 1034 | ral 2000 | ral 2001 | ral 2002 | ral 2003 | ral 2004 | ral 2008 |
| ral 2009 | ral 2010 | ral 2011 | ral 2012 | ral 3001 | ral 3002 | ral 3003 | ral 3004 | ral 3005 | ral 3007 | ral 3009 | ral 3011 | ral 3012 | ral 3013 | ral 3014 | ral 3015 |
| ral 3016 | ral 3017 | ral 3018 | ral 3022 | ral 3027 | ral 3031 | ral 4001 | ral 4002 | ral 4003 | ral 4004 | ral 4005 | ral 4006 | ral 4007 | ral 4008 | ral 3015 | ral 3015 |
| ral 5001 | ral 5003 | ral 5004 | ral 5005 | ral 5007 | ral 5008 | ral 5009 | ral 5011 | ral 5012 | ral 5013 | ral 5014 | ral 5015 | ral 5017 | ral 5018 | ral 5019 | ral 5020 |
| ral 5021 | ral 5022 | ral 5023 | ral 5024 | ral 6000 | ral 6001 | ral 6002 | ral 6003 | ral 6004 | ral 6005 | ral 6006 | ral 6007 | ral 6008 | ral 6009 | ral 6010 | ral 6011 |
| ral 6012 | ral 6013 | ral 6014 | ral 6015 | ral 6016 | ral 6017 | ral 6018 | ral 6019 | ral 6020 | ral 6021 | ral 6022 | ral 6022 | ral 6025 | ral 6026 | ral 6027 | ral 6028 |
| ral 6032 | ral 6033 | ral 6034 | ral 7000 | ral 7001 | ral 7001 | ral 7002 | ral 7003 | ral 7004 | ral 7005 | ral 7006 | ral 7008 | ral 7009 | ral 7010 | ral 7011 | ral 7012 |
| ral 7013 | ral 7015 | ral 7016 | ral 7021 | ral 7022 | ral 7023 | ral 7024 | ral 7026 | ral 7030 | ral 7031 | ral 7032 | ral 7033 | ral 7034 | ral 7035 | ral 7036 | ral 7037 |
| ral 7038 | ral 7039 | ral 7040 | ral 7042 | ral 7043 | ral 7044 | ral 8000 | ral 8001 | ral 8002 | ral 8003 | ral 8004 | ral 8007 | ral 8008 | ral 8011 | ral 8012 | ral 8014 |
| ral 8015 | ral 8016 | ral 8017 | ral 8019 | ral 8022 | ral 8023 | ral 8024 | ral 8025 | ral 8028 | ral 9001 | ral 9002 | ral 9004 | ral 9011 | ral 9016 | ral 9017 | ral 9018 |



MT DISPLAYS LLC
1081 Hanover St.
Wilkes-Barre, PA 18706
T: +1 855-478-0652
+1 855-478-0363
info@mtdisplaysllc.com
www.mtdisplaysllc.com

www.mtdisplays.com
www.omni-frame.com
www.opti-frame.com

